



Final Report

01.08.2001 – 31.07.2004

Contract number IST-2000-28185

17.11.2004

Deliverable D15

Version 1.0

Public / restricted report
Project deliverable as defined in the
contract

Authors

Christian Maihöfer, DCA
Christian Brenzel, BOS
Luca Coletti, SMC
Michele Provera, CRF
Martin Nelisse, TNO
Dirk Verburg, TNO
Wolfgang H. Schulz, UCO
Jing Tian, USTUTT
Horst Burnmeister, DCA

Project Co-ordinator:

Dr. Christian Maihöfer
DaimlerChrysler AG – Dept. RIC/TC HPC U800
Wilhelm Runge Strasse 11
D-89081 Ulm, Germany
Phone +49 731 505 2173– Fax +49 731 505 4110
e-mail: christian.maihoefer@daimlerchrysler.com

Status:

Final

Scheduled Delivery Date:

July 31, 2004

copyright: 2004 CarTALK 2000 Consortium

Revision chart and history log

Deliverable due date: 31.07.2004 (project month 36)

Version	Date	Reason	Status
0.1	09.06.2004	Draft table of contents (IMC)	Draft
0.2	28.06.2004	Collection of individual material (CM)	Draft
0.3	04.07.2004	Preliminary release for final review (CM)	Draft
0.4	27.09.2004	Additions included as requested by the commission	Draft
0.5	14.11.2004	Preview final	Draft
1.0	17.11.2004		Final

Table of contents

Authors.....	ii
Project Co-ordinator:	ii
Status:	ii
Scheduled Delivery Date:.....	ii
Revision chart and history log.....	iii
Table of figures	vi
Table of tables	vii
1 Project objectives and approach	10
1.1 Summary of the main achievement.....	10
1.2 Description of work.....	11
1.3 Approach followed to achieve project objectives.....	11
1.4 Consortium composition and roles	13
2 Project results and achievements	15
2.1 Scientific and technological achievements.....	15
2.1.1 Enabling research and specification	15
2.1.2 System architecture	16
2.1.3 Communication system.....	25
2.1.4 Applications.....	31
2.2 Safety Verification	46
2.2.1 Introduction	46
2.2.2 Preliminary Hazard Analysis	47
2.2.3 Safety Requirements of the Communication System...	47
2.2.4 Safety Verification	49
2.2.5 Conclusion	51
2.3 Legal and Liability Aspects.....	51
2.4 Socio-economic assessment.....	53
2.5 Standardisation and market introduction.....	56
2.5.1 Input to Standardisation	56
2.5.2 Potential market introduction.....	58
2.5.3 Basic problem for getting vehicle-vehicle communication into the market	60
2.5.4 Equipping police and ambulance vehicles, service cars of automobile clubs	61
2.5.5 Equipping road works with IWF beacon.....	62
2.5.6 Equipping Set Of Lights with IWF beacon.....	63
2.5.7 Support by Insurance Companies.....	63

2.5.8 Support by value adding services, Hot spot advertising.....	64
2.5.9 Introduction Strategy	64
2.6 Dissemination	70
3 Lesson learned and future developments	71
3.1 Lessons learned	71
3.2 Future developments.....	72
4 Conclusions.....	79

Table of figures

Figure 1: Vehicle Message Definition	16
Figure 2: Functional architecture	17
Figure 3: AMI-C Reference Architecture	18
Figure 4: OSGi Reference Architecture	19
Figure 5: CarTALK reference architecture	19
Figure 6: CRF Reference Architecture	21
Figure 7: CRF Hardware/Software Architecture	21
Figure 8: DCA Reference Architecture	22
Figure 9: DCA Hardware/Software Architecture	22
Figure 10: TNO Reference Architecture	23
Figure 11: TNO Hardware/Software Architecture - Part 1.....	24
Figure 12: TNO Hardware/Software Architecture - Part 2.....	24
Figure 13: IWF – Extended Blind Spot scenario	35
Figure 14: IWF – Intersection Warning scenario.....	35
Figure 15: CBLC2 (Early Braking) Scenario	36
Figure 16: Description of demonstrator interface.....	39
Figure 17 – Demonstrator vehicle. Picture shows an alternative S-class demonstrator.....	40
Figure 18 – GPS-antenna (left) and WLAN-antenna (right).....	40
Figure 19 – Vehicle PC on the left and CarTALK application PC on the right.....	41
Figure 20 – TFT-Display for programming and debugging	41
Figure 21 – TNO test vehicles	42
Figure 22 – Illustration of human machine interface	42
Figure 23 – WLAN antenna on roof of Smart.....	43
Figure 24 – Visualization of neighbourhood.....	43
Figure 25 – Integration of equipment in trunk of vehicle	43
Figure 26 – CRF first prototype: Fiat Stilo Abarth	44
Figure 27 – Fiat Stilo: vehicle roof	44
Figure 28 – CRF second prototype: Alfa Romeo 147	45
Figure 29 – CRF second prototype: detail of the interiors	45
Figure 30 – Example of the on-board HMI	45

Table of tables

Table 1: Communication requirements	16
---	----

Project overview

The CarTALK 2000 consortium brought together the extensive knowledge of the leading European manufacturers of vehicles, vehicle components and communication systems, plus renowned research institutes. The seven partners DaimlerChrysler, CRF, BOSCH, Siemens, TNO, University of Stuttgart and University of Cologne focussed its research activities on safety related communication based driver assistance systems.

In more detail, this goal encompassed the following work:

- Specification of today's and future applications for co-operative driver assistance systems and selection of those which can be realized in the framework of this project.
- Develop software structures and algorithms, e.g. new fusion techniques for radio-based sensor information and local sensor information
- Development of a self-organising radio system for inter-vehicle and vehicle-infrastructure communication
- Algorithms for radio ad-hoc networks with extremely high dynamic network topologies
- Integrate the communication system hardware and algorithms into test vehicles
- Integrate the applications into probe vehicles to test and demonstrate both, info-mobility applications (existing applications) and safety applications in the same system architecture.
- Test and demonstrate assistance functions in probe vehicles in real traffic scenarios

All major work tasks ended up in deliverables, conference or journal publications, three patent applications and finally they all converged into the demonstrator system.

In the final demonstration in July in Balocco, the CarTalk consortium has demonstrated its result with six probe vehicles and a comprehensive simulation environment for the three application clusters:

- Information & Warning Functions (IWF)
A signal is transmitted which indicates a vehicle breakdown, detected traffic density and congestions, or road surface conditions. This allows an early warning of the driver of following vehicles on the same road.
- Communication-Based Longitudinal Control (CBLC)
By integrating communication to existing ACC systems, these systems adapt longitudinal control to the whole vehicle convoy in front not only the direct vehicle ahead. This leads to more natural following behaviour. Moreover, it helps avoiding accidents that occur due to the inattention of the vehicle in front. In the long term perspective, this includes platooning manoeuvres.

- Co-operative Driver Assistance (CODA)

A typical scenario for co-operation is an intersection situation, lane merging, or highway entry. By exchanging information up to simple trajectory plans, critical situations can be foreseen and solved by the vehicles themselves.

Apart from technological goals, CarTALK 2000 actively addressed market introduction strategies in particular addressing the penetration problem, including cost/benefit analyses, and legal aspects.

The socio-economic assessment has been carried out for the basic warning function from the IWF class and for the early braking function from the CBLC class. In short both systems, basic warning and early braking will lead to significant benefits by reducing accidents and hence are desirable from a societal point of view.

In more detail, the benefit-cost ratio on the EU-level range between 1.16 (100% equipment rate) and 1.46 (10% equipment rate) for basic warning with pessimistic assumptions. This means, introducing this function is positive for the society. An investment of 1 Euro leads to a minimum social rate of 1.46 Euro. The benefit-cost ratio for early braking on the EU-level range between 1.14 (10% EQR) and 3.98 (40% EQR) with pessimistic assumptions. For basic warning the surplus ranges in between 11 Mill. € (EQR=10%) and 41 Mill. € (EQR=100%). The surplus for early braking increases from 6 Mill. € (EQR=10%) up to 653 Mill. € (EQR=100%). That means that a full market introduction of both systems is favorable.

The capacity effect as result of decrease of congestions caused by congestion is positive, but plays only a minor role for the total benefits.

The consortium aimed at the standardisation and pave the way for bringing these systems to the European market. For standardization, the Car-to-Car Communication Consortium was founded including not only the CarTALK vehicle manufacturers DaimlerChrysler and Fiat but also BMW and VW/Audi. More European vehicle manufacturers and major equipment suppliers are supposed to join soon.

This shows a clear approval and finally the success of the research made in CarTALK and their continuation in industry in less research-like but more development-like open European industry projects and already started development programs and commercial aftermarket systems introducing new communication technologies to vehicles. Without CarTALK and accompanying national research projects this would have been unlikely to happen, not only because of the missing necessary knock-on financing but because only in these programs it was possible to bring all necessary knowledge which cannot be found in a single company together.

1 Project objectives and approach

1.1 Summary of the main achievement

The technical objectives of CarTALK 2000 were to develop and realise co-operating driver assistance systems, to develop an extendable self-organising radio system for inter-car communication aiming at an emerging standard. The main results achieved have been:

- Defining an open architecture which allow vehicle manufacturer to bring together their predominant proprietary electronics architecture with the well defined CarTALK communication system.
- Defining and realizing an open decentralised communication system which supports a broad range of applications for entertainment and information purposes as well as safety related CarTALK applications.
- Defining and realizing the three major safety related application classes:
 - Information & Warning Functions (IWF), which disseminate information about traffic jams, dangerous road surface conditions, intersection warning, etc.
 - Communication-Based Longitudinal Control (CBLC), which adapt longitudinal control, i.e. acceleration and deceleration to the whole convoy in front, resulting in increased safety more natural following behaviour and traffic flow
 - Co-operative Driver Assistance (CODA), which allow automatic or assisted complex manoeuvres like lane merging and highway entering.
- Integration of the communication system hardware and algorithms and the applications into test vehicles.
- Integrate the applications into probe vehicles to test and demonstrate both, info-mobility applications (existing applications) and safety applications in the same system architecture.
- Show the feasibility of the applications and their market introduction by a socio-economic assessment with a cost benefit analysis.
- The CarTalk 2000 project consortium has published its results in more than 20 scientific papers (journal and conference proceedings) so far. More publications after the official project end are expected because some results are only available from now on and earlier publications would have not been plausible.
- Active results and experience sharing with other national and European research projects like FleetNet, NoW, INVENT,

IVHW, GALLANT, ADASE II, RESPONSE, PREVENT, WILLWARN and others.

- Establishment of the Car-to-Car Communication Consortium (C2C-CC) with major European vehicle manufacturers and open to major equipment suppliers. C2C-CC will result in an industry standard for communication system and safety applications shared by most or all European vehicles manufacturers.

1.2 Description of work

The major goal of CarTalk 2000 was the development of co-operative driver assistance systems based on inter-vehicle communication. In more detail, this goal encompasses the following work:

- Specification of today's and future applications for co-operative driver assistance systems and selection of those which can be realized in the framework of this project
- Develop software structures and algorithms, e.g. new fusion techniques for radio-based sensor information and local sensor information
- Development of a self-organising radio system for inter-vehicle and vehicle-infrastructure communication
- Algorithms for radio ad-hoc networks with extremely high dynamic network topologies
- Integrate the communication system hardware and algorithms into test vehicles
- Integrate the applications into probe vehicles to test and demonstrate both, info-mobility applications (existing applications) and safety applications in the same system architecture
- Test and demonstrate assistance functions in probe vehicles in real traffic scenarios

In the end, the success of the project depends on whether the demonstrator vehicles are able to realize the applications as anticipated by the project because all major work packages converge in the demonstration.

Apart from technological goals, CarTALK 2000 actively addressed market introduction strategies including cost/benefit analyses and legal aspects, and aims at the standardisation to bring these systems to the European market.

1.3 Approach followed to achieve project objectives

To achieve the project goals the project has taken the following approach and has gone through six phases

- Analysis of system requirements and functional specifications,

- System architecture,
- Communication protocol and application development,
- Integration into test vehicles,
- Validation of the applications in real conditions,
- Standardisation and exploitation planning.

These project phases have been mapped onto five technical work packages (WP02-05) supported by an organisational work package (WP01) covering the operational project management.

WP01, "Project management", has conducted the operational lead and controlling of CarTALK 2000 and communication and liaison of the project achievements within the IST programme, other national and international research programmes and to the outside. This included all administrative and non-technical aspects of the project, the exchange of information between the partners in order to provide the highest visibility of the status of the project as well as to provide quality control and assessment of all project objectives and deliverables.

WP02, "Enabling research and specification", investigated all technical areas, specified the communication-based assistance systems, decided upon anticipated scenarios for the verification phase, and identified requirements for the communication system and the technological solutions to be used.

WP03, "System architecture", combined both, co-operative assistance systems and ad-hoc communication networks in a common architecture. Building the framework for the project work, this work package also ensured functional safety of the applications and protocols.

WP04, "Communication system", designed the radio communication system. A prototype was realised for testing in the selected scenarios. The design phase has developed a system, which is open to other applications as well. Specific recommendations have been defined for the phase after the technological prototype development, the pre-industrialisation, and preparation for the appropriate standardisation bodies. The "Communication system" was the largest work package because it included a wide range of activities from frequency selection, considering and realizing three options for the communication hardware, ad hoc communication protocol design, specification, implementation, testing and extensive dissemination activities.

WP05, "Applications", developed extended driver assistance systems based upon communication. It was the second largest work package. A set of 6 fully interoperable test vehicles have been built up for test and demonstration, including mixed assistance and infotainment applications to show the integration of both. The "Applications" work package was the heart of the project because here all enabling research, design and implementation work has been gathered to come up with a demonstrator showing the result of all efforts.

WP06, "Standardisation and market introduction", defined and analysed introduction scenarios for system deployment and technology implementation. Supporting work on standardisation in

C2C-CC, legal and liability issues and the socio-economic impact of CarTALK 2000 systems was carried out. Results have been shared with the RESPONSE II project and a workshop have been joint by CarTALK 2000 partners. Dissemination activities have been carried out at conferences, exhibitions and concerted actions with the EC and activities are still on-going.

The overall work progress of the project was measured by four milestones at which tangible results have been achieved.

Month 6: This milestone marked the end of work package 02. All initial research was done. The applications have been defined and the operational requirements have been specified. Work on the system architecture and application development has then begun.

Month 15: This milestone marked the end of the design and development of the architecture work. The overall system architecture and the communication architecture have been defined.

Month 27: This milestone marked the end of the application development and the end of the safety analysis for the communication system. The demonstrations and field trials have then begun, as the system was now available on demonstrator vehicles.

Month 36: This is the scheduled end of the project. The field trials are finished and evaluated. The technological implementation plan is ready.

1.4 Consortium composition and roles

Under the co-ordination of DaimlerChrysler the CarTALK 2000 consortium brought together the extensive knowledge of the leading European manufacturers of vehicles, vehicle components and communication systems, plus renowned research institutes.

CarTALK 2000 focussed its research activities on safety related communication based driver assistance systems. As experienced representatives of the European automotive industry in the field of ADAS, DaimlerChrysler and CRF will took up the challenge of designing the CarTALK systems as well as to build prototype vehicles for test and evaluation. Being a major European automotive equipment supplier with a great experience in assistance systems and previous work in radio-based warning systems, BOSCH proved to be a highly valuable partner in system conception and in the realization of the Information and Warning Functionality (IWF). As an experienced partner in many European projects on ADAS, TNO supported the design, analysis and evaluation of the CarTALK applications. They focussed on the issue of a system architecture and built up demonstrator vehicles.

In order to reach the goal of enhancing the high level of safety and comfort of ADAS systems, the CarTALK 2000 consortium also comprised the partners Siemens Mobile Communication and the University of Stuttgart. They brought in their great experience in communication technologies and protocols and developed the

communication system for safety related driver assistance systems.

The clear emphasis on industrial feasibility was not only shown by the co-operation of vehicle manufacturers, supplier and research institutes but also explicitly by the definition of future traffic scenarios and their cost benefit analysis. This analysis was provided by the University of Cologne.

Finally one of the leading European law firms, CliffordChance, contributed to the project by providing answers on legal and liability issues in co-operation with the Response 2 project.

2 Project results and achievements

2.1 Scientific and technological achievements

2.1.1 Enabling research and specification

This work package provided the basis for all the work covered in CarTALK 2000. Its objective was to investigate all technical areas and application requirements. It provided the basis for the selection of the scenarios for the technological feasibility tests and the verification phase. It defined the requirements to be met by the communication system and the technological solutions for the applications.

About the requirements to be met by the communication system, it was found that the physical layer should support high velocities, operation in multipath environments and high system reach. The higher layers should support adaptation to different data rates and reservation of radio resources for high priority services. We have to standardise the air-interface (well-specified interfaces) and the system requires a licence-free frequency band.

Requirements best suited to support the demands of the target system and applications are:

- High velocity (< 500 Km/h);
- Large radio range (>500 m);
- Adaptive data rate (30 kbps-1 Mbps);
- Availability of unlicensed spectrum;

On the other hand, services to be provided include:

- Multicasting of periodic data traffic to propagate cruising information to the surrounding vehicles for traffic control;
- Broadcast of alarm messages;
- Point-to-point communications between terminals with QoS features;

About the application clusters, the three CarTALK 2000 clusters have different properties, offering various services in order to improve the driving conditions and to increase comfort and safety of passengers. Every application demands particular requirements (e.g. type of vehicle, geographic position, low delays of transmission, high reliability, etc.). The information that vehicles must exchange has been identified in terms of signals type and related requirements. A unique message, containing all needed signals and common to all the demo applications, has been specified in previous CT deliverables.

Signal	Units	Fomat	Bytes	Accuracy	Type	Rate (Hz)
Common Message (IWF & CBLC & CODA)						
timeStamp	ms	ASCII	9		Cyclic	50
vehicleID	-	DWORD	4	-	Cyclic	50
vehicleType	-	ENUM	1	-	Cyclic	50
length	m	FLOAT	4	0.1	Cyclic	50
width	m	FLOAT	4	0.1	Cyclic	50
positionLatitude	deg	FLOAT	4	0.000001	Cyclic	50
positionLongitude	deg	FLOAT	4	0.000001	Cyclic	50
positionAltitude	m	FLOAT	4	0.01	Cyclic	50
positionYaw	deg	FLOAT	4	0.5	Cyclic	50
positionAccuracy	m	FLOAT	4	-	Cyclic	50
velocity	m/s	FLOAT	4	0.5	Cyclic	50
velocityHeading	deg	FLOAT	4	-	Cyclic	50
velocityYaw	deg/s	FLOAT	4	0.5	Cyclic	50
acceleration	m/s ²	FLOAT	4	0.5	Cyclic	50
laneID	-	ENUM	1	-	Cyclic	50
roadID	-	QWORD	8	-	Cyclic	50

Figure 1: Vehicle Message Definition

Hence about 67 bytes are needed for the common message of the applications. Two additional bytes for the specific signals of the applications are taken in consideration.

Besides the communication system itself, it was essential in the enabling research phase to look at the prospective applications to be supported by the communication system. The goal was to derive requirements for the communication system from our applications such that we design the communication system with all relevant demands clearly specified in advance. The three application clusters make different demands on the communication system. Such communication requirements with an estimation of size of application messages is provided and summarized in the following table.

	IWF 1	IWF 2	IWF 3	CBLC 1	CBLC 2	CODA
One-Hop transmission Range [m]	1000	1000	1000	500	500	500
Multihop	+	+	+	+	+	-
Broadcast	+	+	+	+	+	+
Unicast	-	-	-	-	-	+
Priority	+	+	+	-	-	+
Repetition rate [Hz]	1-10	25-50	10	10-20	20-50	20-50
Maximum delay [ms]	100	100	100	100	100	100
Message Size [Byte]	65	65	65	65	65	65

Table 1: Communication requirements

2.1.2 System architecture

Based on the initial research this work package provided the design of the CarTALK 2000 system. The architecture chosen combines both, co-operative assistance systems and ad-hoc communication networks. Building the framework for the

integration of the project work, this work package also ensured the functional safety of the applications and protocols.

CarTALK functional architecture

Co-operating driver assistance systems can be characterized by five key components as shown in the functional architecture of Figure 2:

- Telematics: mainly a form of HMI informing the user about the status and advices of the system
- Vehicle Signals: sensors and signals within this vehicle
- Communication: exchange of signals between this vehicle and vehicle in the neighborhood
- Localization: accurate positioning system necessary for onboard processing but also for communication (e.g. routing)
- On board processing: the algorithms necessary to handle the ADAS scenarios and any additional algorithms

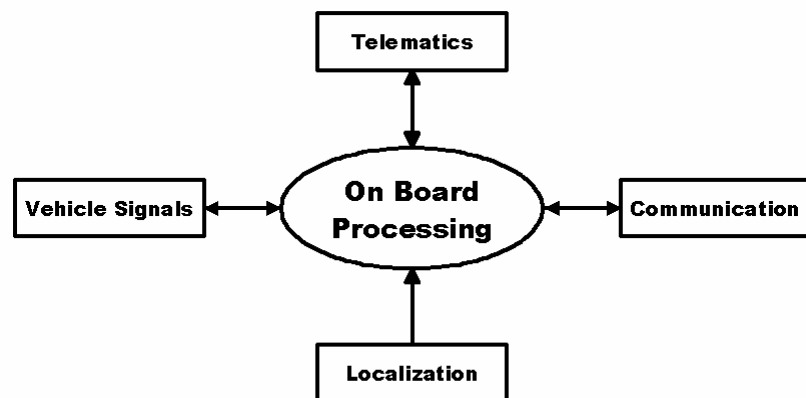

Figure 2: Functional architecture

An initial survey of the required computing power showed that a single computer solution is likely to provide insufficient computing resources. The CarTALK system architecture therefore should allow for distributed computer systems, but also include the possibility for a highly integrated system. To ensure that the system can be extended later on with add-on components it was determined that the CarTALK reference architecture should be in-line with the two main players in this area: the AMI-C and OSGi architectures.

AMI-C Reference Architecture

The Automotive Multimedia Interface Collaboration (AMI-C) is a worldwide organization of motor vehicle manufacturers created to facilitate the development, promotion and standardization of

automotive multimedia interfaces to motor vehicle communication networks.

The AMI-C reference architecture has an OEM proprietary part and a 'open' AMI-C compliant part (see Figure 3). The OEM proprietary part is the responsibility of the car manufacturer itself. The AMI-C compliant part is open for third party extensions and devices. The main concept in the AMI-C reference architecture is the use of gateways, in order to hide implementation aspects of other (sub-) systems parts.

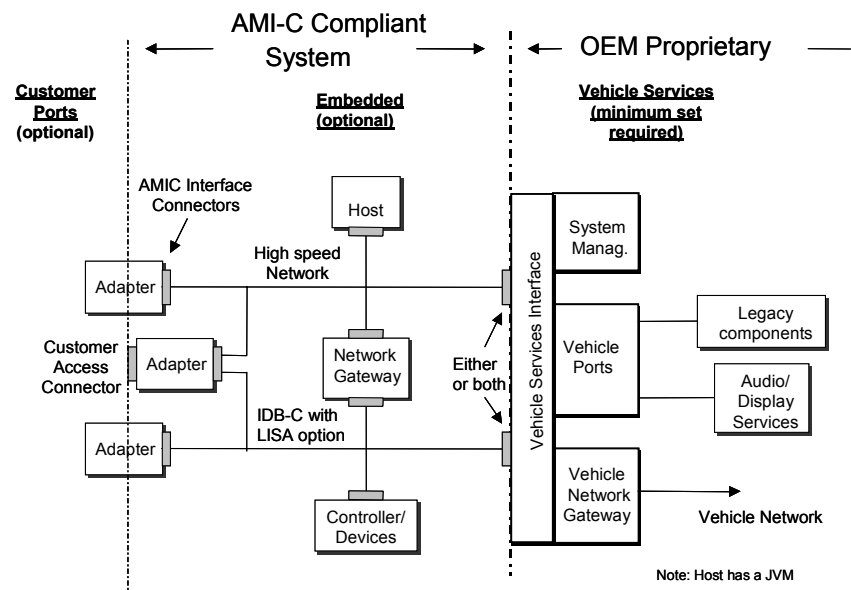

Figure 3: AMI-C Reference Architecture

OSGi Reference Architecture

The Open Services Gateway Initiative (OSGi) facilitates the installation and operation of multiple services on a single open services gateway (set-top box, cable or DSL modem, PC, Web phone, automotive, multimedia gateway or dedicated residential gateway) as is shown in Figure 4.

A key item in OSGi is the role of the Services Gateway, this component will link dissimilar networks (e.g. WAN and LAN) and it will provide an open framework, which API can be used by various services running on top of it.

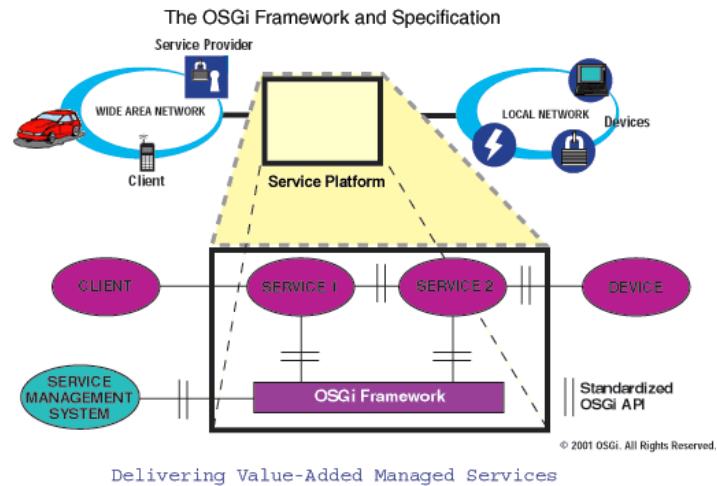

Figure 4: OSGi Reference Architecture

CarTALK Reference Architecture

The CarTALK Reference Architecture (see Figure 5). closely follows the gateway concept of AMI-C and OSGi with an in-vehicle OEM and inter-vehicle communication gateway. The telematics and Vehicle control parts are just like in AMI-C placed in the ,open' environment and the open communication specification can be used to establish inter-vehicle communication for ADAS applications from different manufacturers.

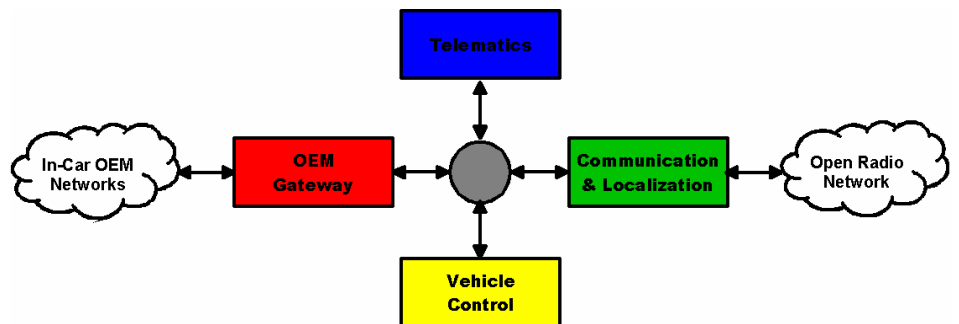

Figure 5: CarTALK reference architecture

Characteristics of the CarTALK reference architecture are:

- There is an OEM gateway that hides any implementation aspects of the in-car OEM networks and provides an open interface to the data on the in-car OEM networks.
- There is a functional unit for wireless communication and positioning, which implements the inter-vehicle communication and provides accurate position information.
- Two different kinds of applications are distinguished: telematics applications and vehicle control applications. Vehicle control applications will perform (real-time) control actions, while telematics applications will handle man-machine interaction.

- The in-car communication is done over an open network. Low and high speeds networks are available.

The inter-vehicle communication network is an open network that is prone to attacks. The use of a firewall and authentication procedure is therefore necessary. It was decided that communication between in-car systems would only be allowed via an application level gateway which could be implemented in a site specific way. The in-car OEM network is a closed network and therefore less prone to attacks, usage of firewall and authentication procedures is therefore left to the manufacturer.

Different implementations

The definition of such a `reference architecture` is an important item in a standardisation proces, because mandatory implementations hinder standardisation and give rise to copyright issues. Since the CarTALK Reference Architecture is a `Reference Architecture`, it is important to note that the three different demo-implementations, build by DCA, CRF and TNO, are all (slightly) different. In the end this shows that the technology developed in CarTALK is really NOT dedicated to a certain manufacturer. The CarTALK technology is in fact open and can be implemented in different ways successfully, while proper car-to-car communication and/or co-operation is still guaranteed.

In short: All partners use a separate laptop computer equipped with WLAN to accommodate CBLC based inter-vehicle communication system, CRF in addition use a FUNKWARNER system for IWF inter-vehicle communication. DCA and TNO build systems of a more distributed nature, while CRF will build a more integrated system. The in-car interconnecting networks are mostly standard networks like Ethernet (supporting UDP/IP) and CAN (high and low speed).

CRF system

The CRF demonstrator follows a centralized processing approach, where the vehicle gateway and vehicle control are integrated in a single computer. The main unit of the on-board system is a Personal Computer. The HMI unit includes an LCD display and a touch screen as input device. As for the positioning functions, the E-Where system gives the vehicle position using `data fusion` algorithms among GPS, a built-in rate gyro, and the odometer signal provided by the vehicle. Location is continuously updated also when GPS data are not available and forwarded to the main unit with a 10Hz refresh rate. The communication gateway is a separate sub-system (laptop) connected via Ethernet to the central computer.

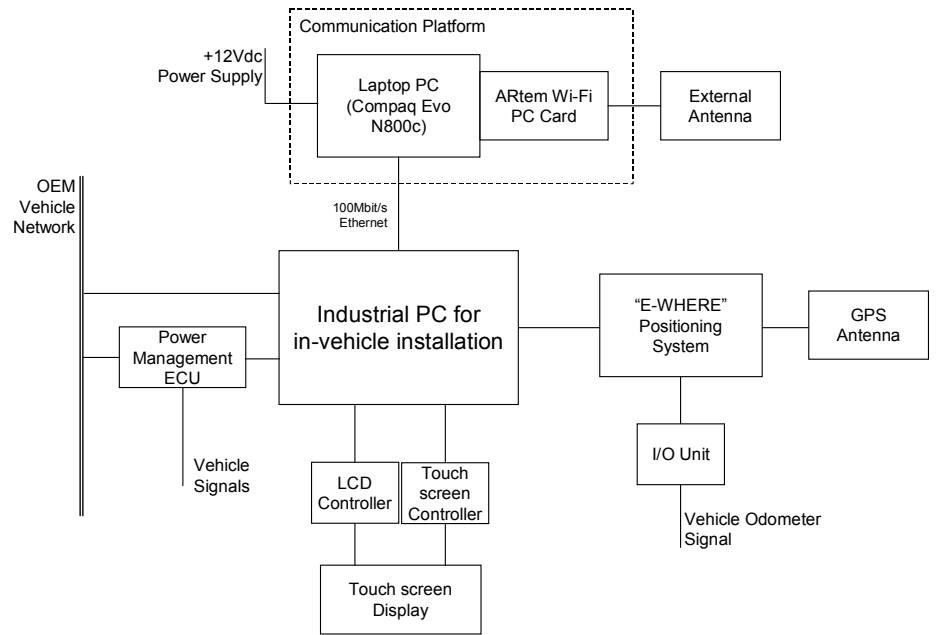

Figure 6: CRF Reference Architecture

All signals are sampled and post-processed at a 100Hz rate and placed in a shared memory (see Figure 7). The different algorithms are run using a round-robin approach at a rate of 10 HZ and they take/place there signals from/in the same shared memory area as used by the data acquisition process.

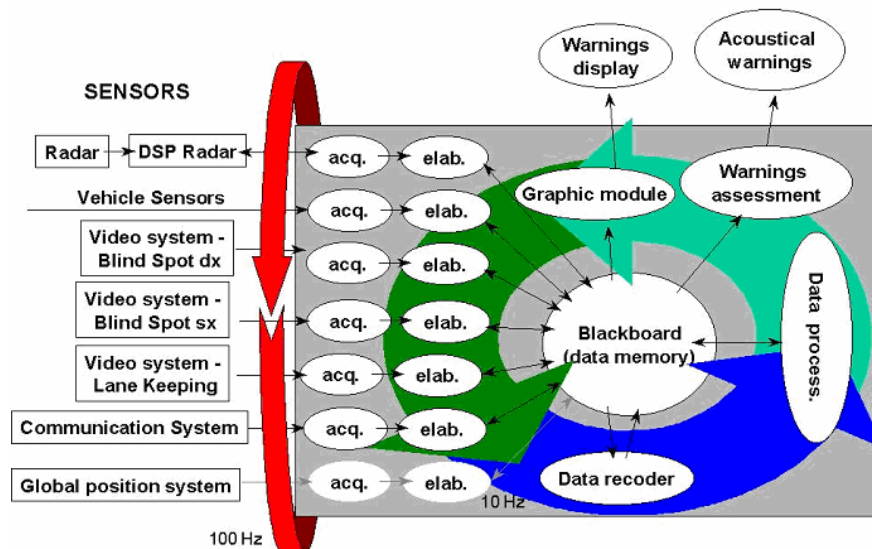

Figure 7: CRF Hardware/Software Architecture

DCA system

The DCA demonstrator (see Figure 8) follows a distributed processing approach, with a separate vehicle- and communications-gateway. The laptop is only responsible for

communication and the application PC runs only application relevant tasks. The controller runs on a dedicated vehicle computer which incorporates extra safety checks and facilitates real-time execution. The interconnection to be used is a fast Ethernet based network.

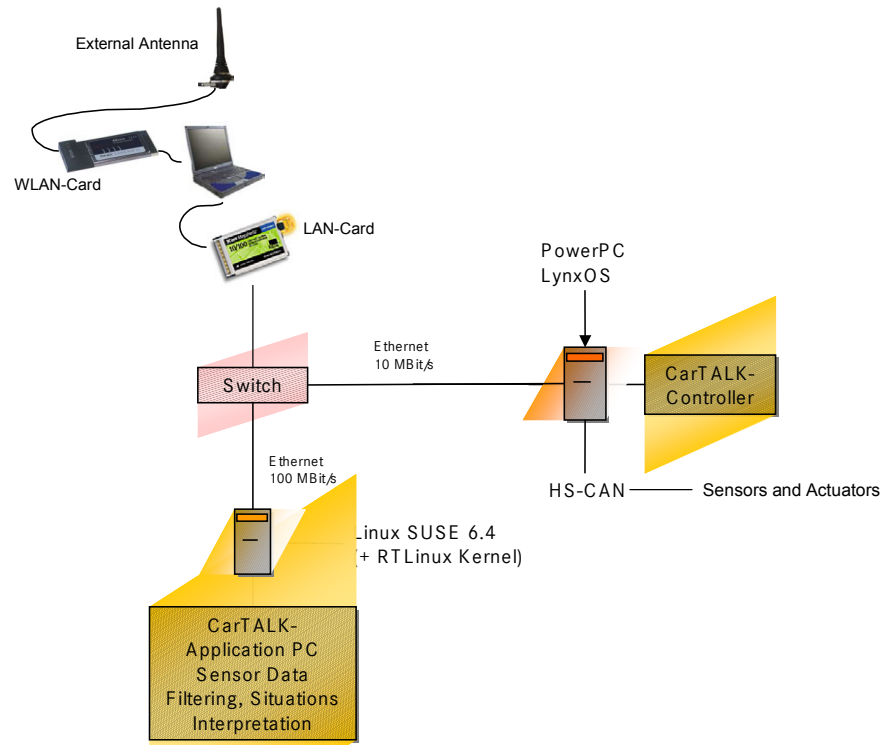

Figure 8: DCA Reference Architecture

Figure 9 shows the mapping of the processes on the processors.

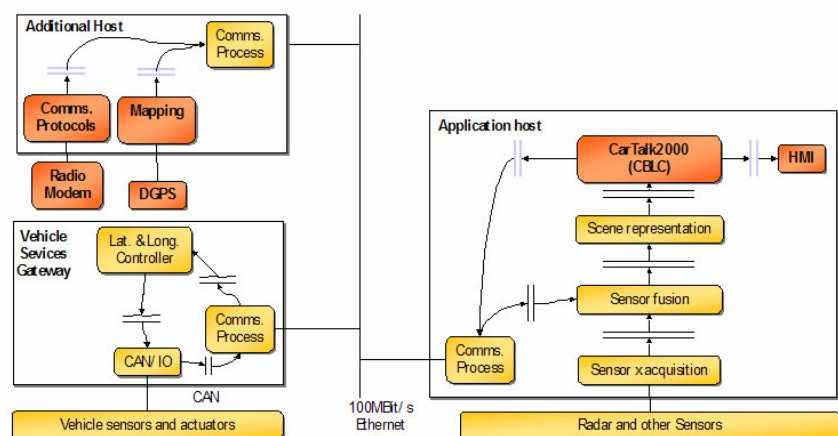

Figure 9: DCA Hardware/Software Architecture

TNO system

The TNO demonstrator (see Figure 10) also follows a distributed processing approach, with a separate vehicle- and communications-gateway. The telematics and localization functions are however not assigned to separate computers but allocated on the same vehicle control computer which also provides the gateway function to the OEM vehicle network. The FunkWarn unit is optional and might even be used in a completely stand-alone way. The Visualization unit is mainly used during the developmental phase of the system, but might be an excellent tool to give an insight view in the working of the system. The interconnection technology to be used is a fast Ethernet based network.

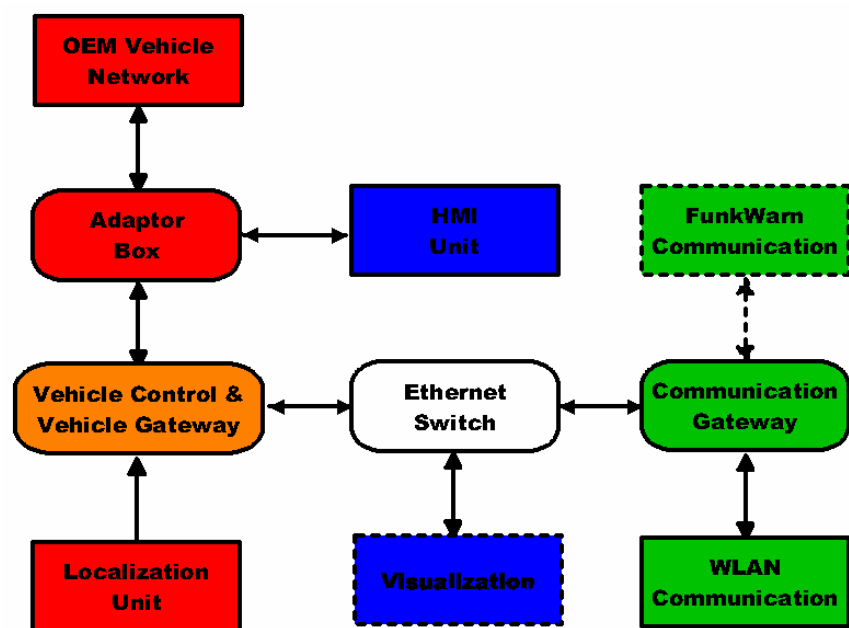

Figure 10: TNO Reference Architecture

Figure 11 and Figure 12 show the component model of the TNO demonstrators and the integration of the World Representation within the Vehicle Control and Vehicle Gateway computer. This component is running as a non real-time task and is interfaced to the CBLC controller via an Ethernet Simulink Port. This approach offered the possibility to run the World Representation component also on other computers in the vehicle, but test runs have shown that the performance impact of this component on the CBLC controller is very small. In fact the World Representation have shown to be capable of running at an update rate of 2kHz while the CBLC running is running at 'only' 50Hz. The World Representation receives input from the remote vehicle (via WLAN) and the sensors in the own vehicle; this input data is checked for consistency and then stored into an internal 'data base'. The CBLC controller asks the World Representation for information on cars in an area in front of the own vehicle, the World Representation then queries its internal 'data base' for cars in this area and returns any cars found. For visualization purposes the

World Representation can also be queried for other dynamic (or static) objects within its internal 'data base'.

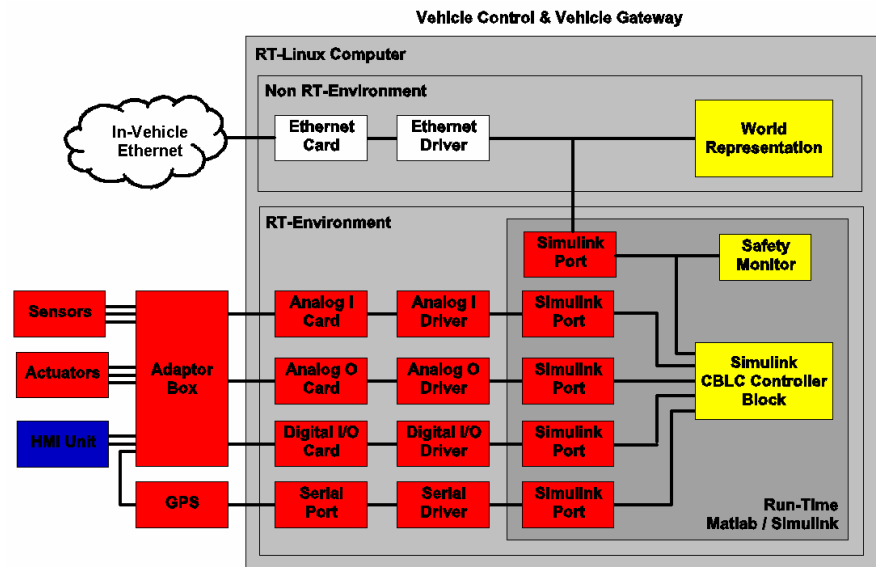

Figure 11: TNO Hardware/Software Architecture - Part 1

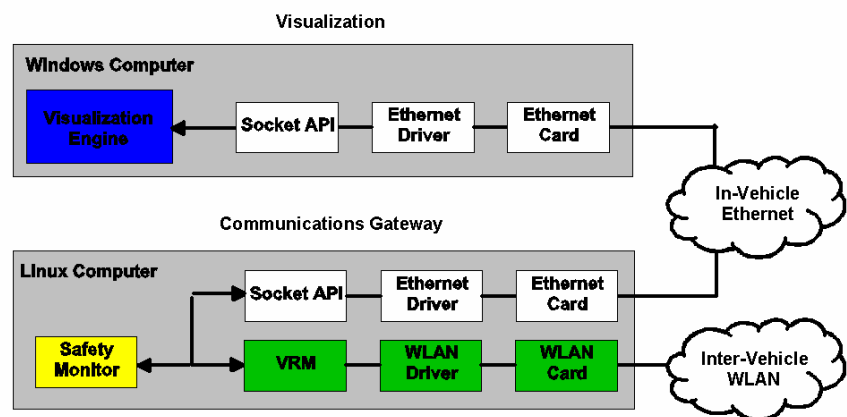

Figure 12: TNO Hardware/Software Architecture - Part 2

The Visualization Engine communicates with the Database within the World Representation via the in-vehicle Ethernet network. The VRM passes all WLAN messages meant for this target vehicle on towards the Vehicle Control and Vehicle Gateway computer. Furthermore it provides hopping functionality to pass on WLAN messages meant for remote vehicles. The safety monitor within the Communication Gateway pairs with the safety monitor within the Vehicle Control and Vehicle Gateway computer, in case the communication between these two processes is disturbed (due to for example a network failure) the CBLC controller will bring the own vehicle into a safe state.

2.1.3 Communication system

The target of this work package was the design the radio communication system.

The choice of the communication technology plays an essential role in the project. Some solutions discussed in the scientific community do not take into account the highly dynamic topology of networks consisting of running cars. For example, the DECT technology does not support an ad hoc mode, which prevents its use in our anticipated scenarios. The following table gives an overview of communication technologies.

	IEEE 802.11a	IEEE 802.11b	HIPERLAN/2	UTRA-TDD	869 MHz	UWB
Frequency	5 GHz	2.4 GHz	5 GHz	2 GHz	869 MHz	1.5 - 5 GHz
Power	1 W	100 mW	1 W	0.1 – 2 W	500 mW	1 – 10 W
Trans. Range	30 – 100 m	350 m	30 – 100 m	> 1000 m	2000 m	1000 m
Bit Rate						
Low Mobility	54 Mbit/s	11 Mbit/s	54 Mbit/s	2 Mbit/s	19.2 Kbit/s	< 250 Kbit/s
Med. Mobility	?	5 Mbit/s	?	384 Kbit/s	19.2 Kbit/s	?
High Mobility	?	3.5 Mbit/s	?	144 Kbit/s	19.2 Kbit/s	?
Synchronisation	-	-	2 ms	10 ms	-	?
Unicast	+	+	+	+	-	+
Broadcast	+	+	+	+	+	?
Priority	O	O	+	+	-	?
Ad Hoc	+	+	O	-	-	+
Multihop	-	-	-	-	-	?
Frequency avail.	-	+	+	+	+/-	O
Exclusive Use	?	-	+	+	-	-
Standardised	+	+	+	+	-	-
Products avail.	+	+	-	-	+	-

If we take a look at the table and compare it with the table on page 16 we see that UTRA-TDD and 869 MHz (SRD) could support directly all applications. Nevertheless, with WLAN and multihop communication or with an adapted WLAN for vehicular use with higher sending power the same advantages can be achieved and therefore its use is possible as well.

In the CarTALK 2000 deliverable D1 part 4 a complete overview and detailed description about existing wireless technologies and standards is provided.

UTRA-TDD

The philosophy of the CarTALK 2000 communication system is to modify an existing air-interface to minimise costs and benefit from mass market. The modified system has an architecture reflected by the one introduced in D6 and the basic functionalities of each architectural block have been described.

With respect to the communication requirements expected and summarized in the previous paragraph, the communication technology for the target system, that we have chosen, is UTRA-TDD, in particular the UTRA-TDD-LCR or TD-SCDMA, since an earlier market introduction can be expected. Rationale for using UTRA-TDD in the CarTALK 2000 communication target system was:

- UMTS Standard;
- UMTS mass market anticipated;
- Looking at the evolution of UMTS, it is furthermore expected that low cost components will be available;
- Offers high flexibility with respect to asymmetric data flows and granularity for data transmission because of its code division multiple access (CDMA) component, and the reservation of transmission capacity owing to its frame and slot structure;
- Because UTRA-TDD is extremely well-suited for packet data transfer, it is also well suited for tomorrow's IP traffic;
- Availability of an exclusive frequency band of 10 MHz in Europe (2010-2020 MHz);
- Support high speeds mobility and sufficient user bit rates;
- Support the communication over large distances and in multipath environment;
- Quality of service (QoS) support. In fact a TDMA system over e.g. a pure FDD or a CSMA system has the possibility to reserve an exclusive part of the frame for high-priority services. This reservation is a basic requirement for QoS guarantees.
- It is appropriate for its application and operation in an ad hoc net;

A comparison, from an architectural point of view, between the current implementation of the UTRA-TDD system and the requirements for an ad hoc architecture has been provided in D6.

As a result, it has been shown that new procedures for synchronisation, power control, medium access control scheme and radio resource management are needed.

A detailed description of the adaptation of the UTRA-TDD standard to the Ad-Hoc mode of operation has been given in D9. The main technical challenge faced has been the development of a completely new MAC scheme. A new protocol, named Reliable R-ALOHA (RR-ALOHA) protocol, has been defined, in order to satisfy CarTALK 2000 system requirements. Based on this protocol, an ADHOC MAC protocol has been designed which operates on a time slotted channel and implements a Dynamic TDMA mechanism that is able to provide prompt access and variable bandwidth reliable channels as needed for QoS delivery.

Results have been disseminated through several conference papers and related to this work, two patents application are pending in the name of Siemens Mobile Communication S.p.A.

In additional results of performed studies allowed to define a preliminary corp of input for Technical Specification (TS) for the physical layer, Data Link Layer (DLL) and Network Layer of CarTALK 2000 communication system.

Since UTRA-TDD technology is not commercially available at the moment, WLAN (cf. IEEE 802.11b) is chosen as basic communication platform for the inter-vehicle communication in the trial system. About the use of standard IEEE 802.11b in CarTALK 2000 communication system, we have to take into account its physical layer limitations. In particular, this technology does provide a smaller communication range of about 500-700m, faces higher packet losses in urban scenarios and it is not guaranteed to operate at high velocities up to 500 Km/h. Other limitations at MAC level have to be taken into account, too.

Nevertheless, standard WLAN proved good results in our demonstrator system such that a vehicular WLAN derivate is now regarded as a suitable candidate for car-to-car communication. With necessary adaptations on the MAC level, QoS and priority handling, and power control we can design a derivate which is only slightly less efficient for our anticipated scenarios compared with other systems. Such modifications are proposed in the resulting document of Task 4.2 "Resource Management".

The Bosch FUNKWARNER system (869 MHz radio channel) was additionally supported mainly for IWF applications.

Narrow band communication using the SRD (Short Range Device) band 869,4 – 869,65MHz

Information and Warning Functions (IWF) require a communication zone large enough to let the driver react accordingly to the situation, e.g. decreasing the vehicle's speed. It is a crucial factor, in particular at low penetration rate during market introduction where the customers expect that the system works, also. SRD has some characteristics that makes it a good choice for introduction of CarTalk2000 application, in particular IWF.

The following overview briefly illustrates the results of comprehensive tests performed with the Bosch Funkwarner System using that SRD band. For further technical details and test setup please refer to the project's document "Comparison narrow and wide band communication system".

Typical Communication range and characteristics	Typical Quality of Service rate	Availability of technology	System complexity and requirements on vehicle infrastructure
Approx. 2 km, no hopping required, in most cases no line-of-sight required, independent of weather conditions.	Approx. 92% starting at 400meters approaching towards the transmitter location. Approx. 86% over a communication range of 2km.	Commercially available in large scale since many years. Reliable and far experienced technology, many chip manufacturers.	Low due no-hop communication, integrateable in today's car Hifi and navigation systems, Sharing of vehicle's mobile phone GSM-Antenna possible.

Wireless LAN (WLAN)

The development of the WLAN consumer technology is outside the focus of this project. Nevertheless, WLAN communication technology offers a cheap and flexible way of communication and vehicular communication standards might be based on WLAN technology.

In the CarTALK project we investigated the limitations of consumer WLAN technology. We found that regarding quality of service, sending power, power management, and reliability consumer WLAN technology has some drawbacks compared to UTRA-TDD or SRD. We proposed specific extensions of consumer WLAN technology which allow us to define a vehicle WLAN standard. For example, higher sending power and power management would allow us to achieve the desired communication range of up to 1000m and high capacity of the communication clusters. We expect that such a modified vehicular WLAN technology is a likely basis for a global inter-vehicle communication standard (cf. Section 3.2).

CarTALK Routing

Besides the lower ISO OSI layer communication hardware the second main task of communication system is to design, implement and standardize a routing protocol for inter-vehicle communications.

CarTALK Routing Environment

Since CarTALK 2000 applications and routing process are located on different computers, we choose a proxy solution for inter-vehicle communications. All messages destined to remote vehicles are first sent to the communication gateway through local Ethernet, the routing process functions like a proxy and routes the message to the remote vehicle through the wireless ad hoc network. A GPS receiver is equipped by the application computer, which periodically sends accurate position information to the routing process.

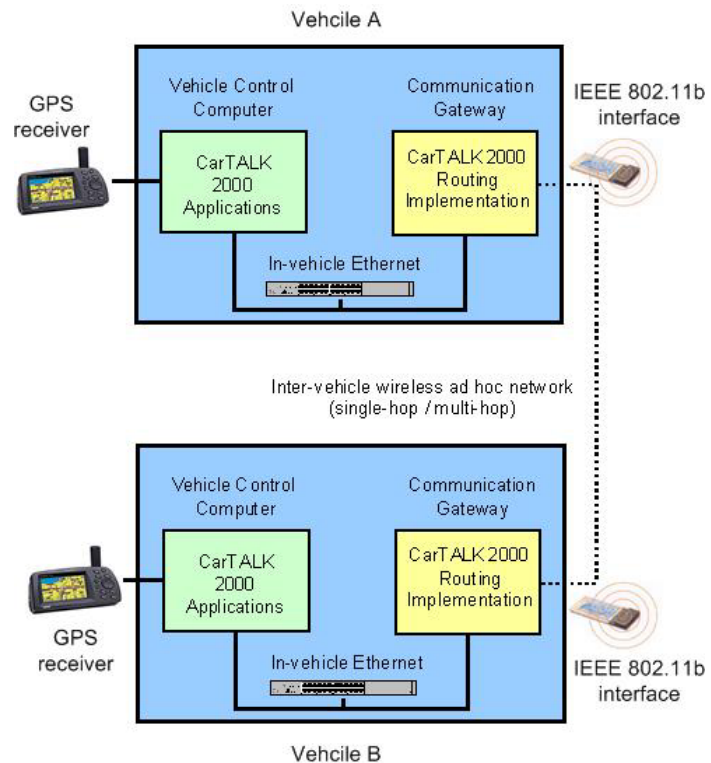

Figure 13: Routing Protocol Environment Overview

CarTALK Routing Protocol Conception and Design

Our conception of the CarTALK 2000 routing protocol is an efficient and scalable routing protocol specifically for inter-vehicle wireless ad hoc networks. In order to choose a suitable design strategy, we have studied the existing ad hoc routing strategies and their suitability for the CarTALK 2000 routing protocol.

Since vehicles can move at very high speeds and the topology of the CarTALK 2000 network is highly dynamic, topology-based routing strategy is too expensive to maintain and thus is not suitable for our target system.

Position-based routing doesn't rely on global network topology, thus avoids the overhead of route discovery and maintenance. Existing work shows that position based routing outperforms topology based routing in highly dynamic scenarios.

Based on the extensive analysis, we choose position-based routing with a simple location service for the CarTALK 2000 routing design.

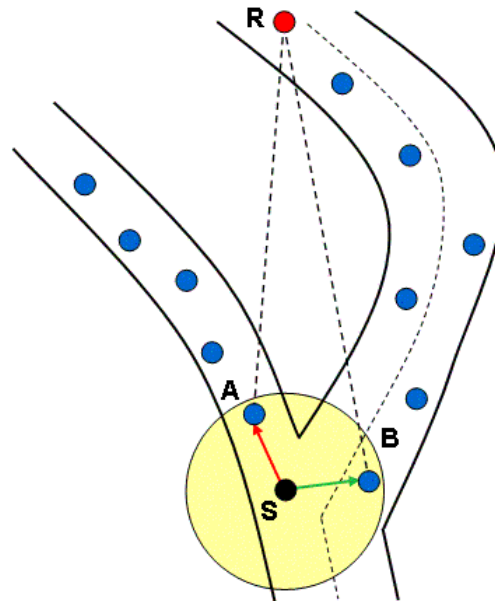

Figure 14: Spatially Aware Routing Conception

Instead of using only position information, we go further and propose a new routing strategy – spatially aware routing. The main contribution of spatially aware routing strategy is to improve the routing performance by using the available topology information of the underlying road network, thus avoiding forwarding decisions that are locally optimal, but globally inappropriate. Figure 14 provides an example of the advantage of using spatial awareness for position-based routing.

CarTALK Routing Protocol Implementation

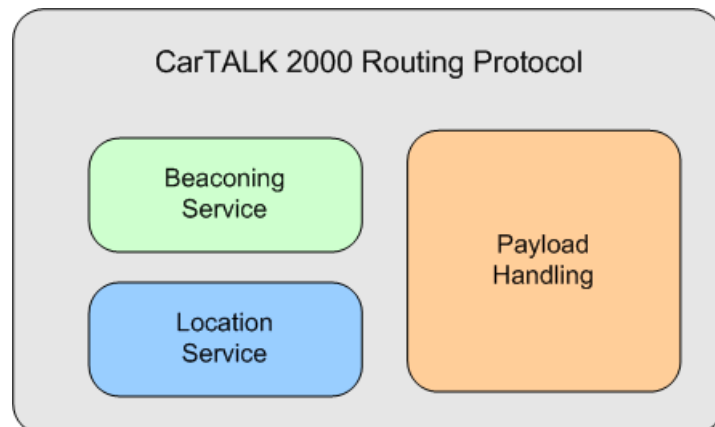

Figure 15: Routing Protocol Component Overview

As shown in Figure 15, the implementation of the CarTALK 2000 routing protocol consists of the following three main components:

- **Beaconing Service:** The beaconing service sends and receives vehicle beacon messages (heartbeats), which are used to maintain the up-to-date neighborhood information of vehicles.
- **Location Service:** For Unicast messages based on destination vehicle identifiers, a location service is used to map the destination vehicle identifier to its corresponding geographic position.

- **Payload Handling:** The payload handling component is responsible for sending, receiving and forwarding application messages. All the routing decision is made by the payload handling component.

CarTALK Routing Protocol Standardization and Evaluation

In the Deliverable D9 we have presented a detailed specification of the CarTALK 2000 routing protocol.

In the standardization of the routing protocol we describe the service provided by the routing protocol and the main components that compose the routing protocol. For the compatibility of possible CarTALK 2000 routing implementations from different vendors, we specify all the message types and formats, the detailed functional specification of the routing protocol and the configuration parameters used in the routing protocol.

Furthermore, we have used both simulation and emulation methods to evaluate the routing protocol. The emulation of an inter-vehicle ad hoc network on a 64-node cluster enables us to test the scalability of the routing protocol, which is very difficult in the real vehicle tests. Our evaluation test results show that the CarTALK 2000 routing protocol is efficient despite of the high network topology dynamicity and can scale to a large number of vehicles.

2.1.4 Applications

This work package performed the development of the extended driver assistance systems based upon communication. A set of 6 test vehicles have been built up for final testing and demonstration. The following functions have been realised.

Information & Warning Functions (IWF)

A signal is transmitted which indicates a vehicle breakdown, detected traffic density and congestions, or road surface conditions. This allows an early warning of the driver of following vehicles on the same road.

Communication-Based Longitudinal Control (CBLC)

Existing ACC systems only react on the vehicle directly in front. By integrating communication, these systems may adapt longitudinal control to the traffic in front. This leads to more natural following behaviour. Moreover, it helps avoiding accidents that occur due to the inattention of the vehicle in front. In the long term perspective, this includes platooning manoeuvres.

Co-operative Driver Assistance (CODA)

A typical scenario for co-operation is an intersection situation. By exchanging information up to simple trajectory plans, critical situations can be foreseen and solved by the vehicles themselves. Another example would be highway entry and merging scenarios.

Information & Warning Functions (IWF)

The purpose is sharing between vehicles all the information about events or situations (dangerous road conditions, emergency braking manoeuvres performed by vehicles in front, accidents, incoming vehicles from merging lanes, etc.) that are outside drivers perception or on-board sensors capabilities, for example because of road geometry, weather conditions or presence of obstacles.

In order to clarify these possibilities, the following IWF scenarios have been chosen for the final demonstration:

Basic Warning

Basic Warning is realized with the Bosch Funkwarner system. It is the outcome of a research project carried out from 1998 to 2001 by Robert Bosch GmbH, BMW AG and Adam OPEL AG. Funkwarner is a stand-alone IWF system using a SRD (Short Range Device) radio channel 869,4 - 869,65MHz. The system supports a set of use-cases like vehicle-breakdown, strong deceleration, accident, slow vehicle and traffic jam but its specification is open to extensions. Due to the long ranging radio communication, drivers will be notified about hazardous conditions within up to 2 km distance. Using GPS information, the driver will not only being notified about the type of warning but also about distance and direction towards the hazard location. A multi stage filter algorithm ensures that mainly relevant warnings will be displayed while others, e.g. from the rear traffic, are rejected.

Funkwarner System Overview

The Central Unit consists of an 16-Bit embedded microcontroller platform with CAN bus interface, a radio transceiver for the SRD 869,4 – 869,65MHz band with 500mW output power and a GPS-Receiver.

The unit processes the vehicle's signals to detect a crucial situation e.g. a strong deceleration, airbag inflation or manual activation by pushing the warning flasher button. If detected, the content of the warning message is compiled of actual data, e.g. the current vehicle position and driving direction and transmitted by the wireless data link to other vehicles. Due to the proximity of the SRD and the GMS900 band, a standard GSM-Antenna may be used.

Received warning messages are checked in the actual context of the receiving vehicle so that relevant information is given to the driver whereas non-relevant, for example from the rear traffic or the opposite driving direction, is rejected.

As the HMI has to be seamlessly integrated into the vehicle's interior, the Funkwarner system just has a simple HMI for demonstration, but offers the choice between two data links for the interconnection with the vehicle's infrastructure: Standard RS232 and CAN-Bus. All information like actual distance and direction towards the hazard location and the type of warning is transmitted on that data link to the vehicle's HMI.

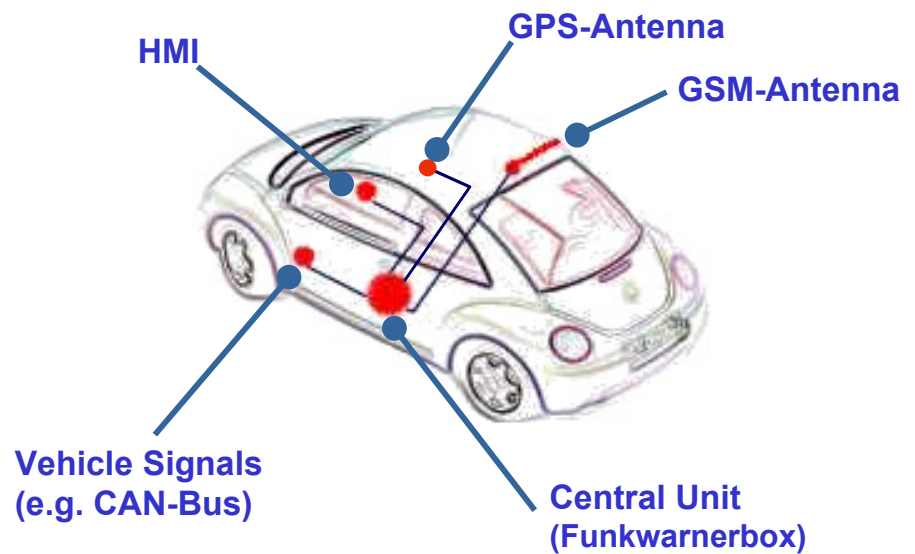

“Expecting the unexpected”: Results of a field test on Driver’s reactions

A comprehensive real live test with 39 candidates has been carried out by the University of Regensburg to find out the driver’s reaction on the Funkwarner system. Vehicles have been equipped with a video monitoring and data logging system and of course the Funkwarner System. A “Technician”, in fact a driving instructor, has accompanied the trips and reported very useful his subjective impressions about the candidates.

After evaluating all gathered information during these tests, the benefit for the driver and the overall traffic safety seems to be obvious: Due to the Funkwarner’s information on approaching the hazard location, the candidates have been driving with increased attention, being prepared to expect the upcoming situation and adopted the vehicle’s speed accordingly. The graph on the vehicle’s speed in relation to the distance shows that very clearly.

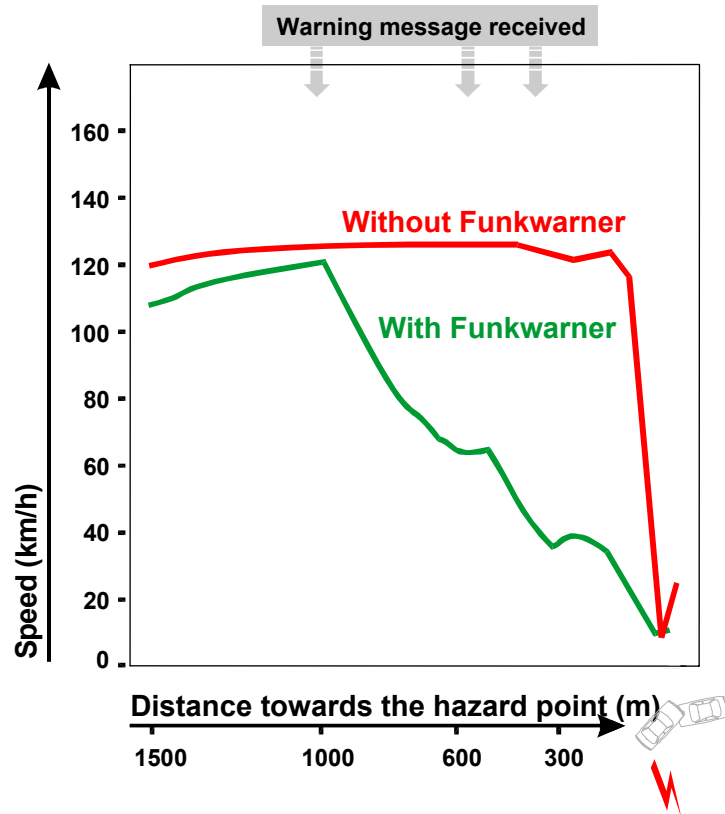

Extended Blind Spot

The Extended Blind Spot scenario aims to demonstrate CarTALK IWF functionalities in a typical situation where the hazard perception is made impossible by vehicles positions and road geometry. Extended blind spot and all following applications are realized with WLAN in the demonstration set up.

In this demonstration, when the two involved vehicles are about to reach lanes intersection, their on-board systems provide drivers with a warning information about the incoming hazard. Hence, the drivers can react autonomously, for example decreasing vehicle speed.

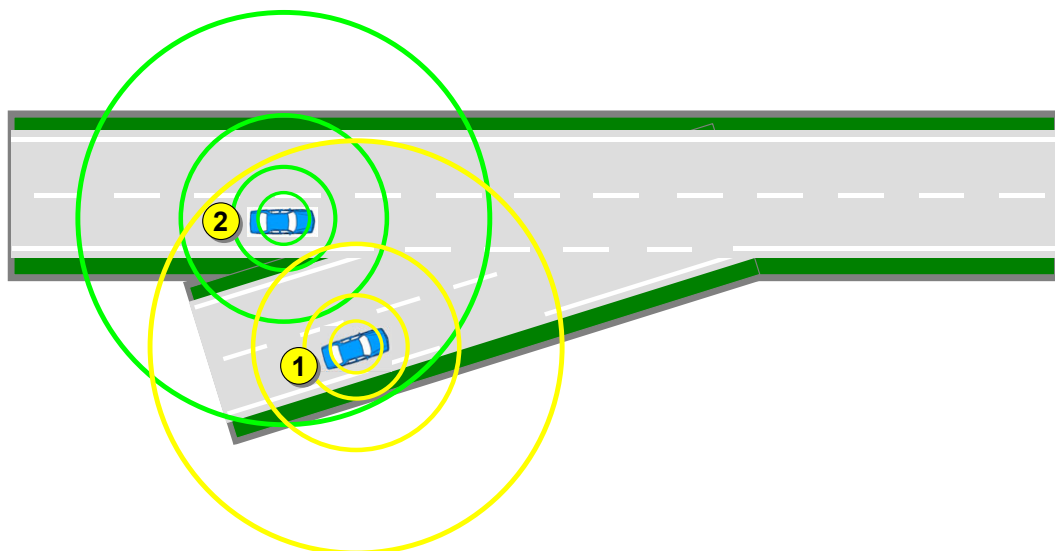

Figure 13: IWF – Extended Blind Spot scenario

Intersection Warning

Intersection Warning demonstration scenario gives rise to a kind of problems that is very similar to the one described in the Extended Blind Spot section.

As a matter of fact, while Extended Blind Spot demonstration aims to simulate a situation that can occur mainly in a highway (an entry lane merging into a main road), the Intersection Warning purpose is to demonstrate CarTALK system usefulness also in a typical urban scenario.

In this case two demo vehicles are approaching a crossing: a potentially hazardous situation, due to the fact that neither the driver, nor the on-board sensors (that typically monitor the road in front of the vehicle itself) can see the vehicle arriving in the intersection.

Similarly to Blind Spot demonstration, also in this case drivers are provided with a warning information about the corresponding hazard.

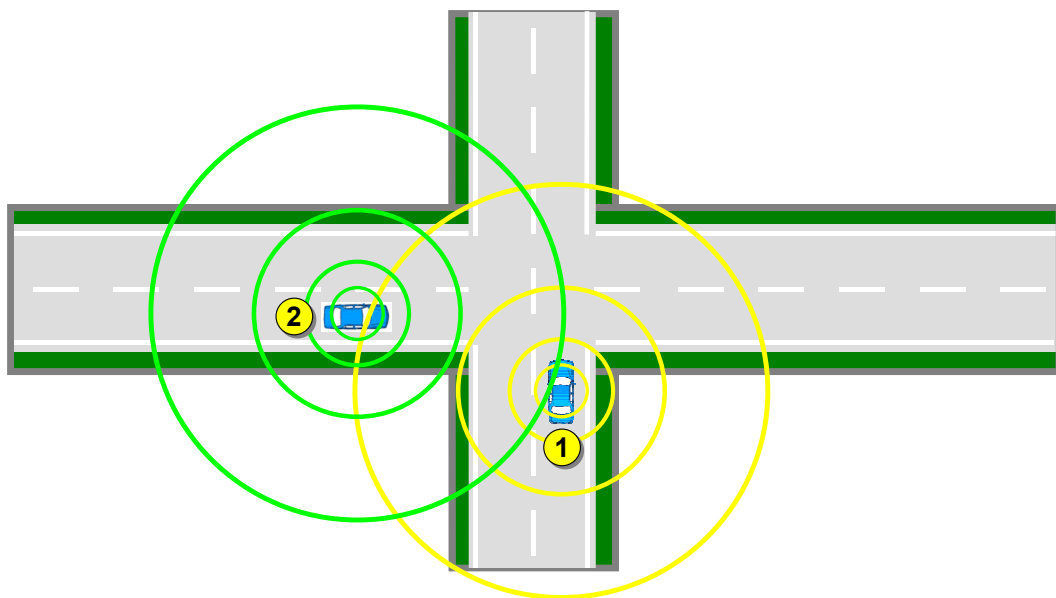

Figure 14: IWF – Intersection Warning scenario

Communication-Based Longitudinal Control (CBLC)

Existing ACC systems only react on the vehicle directly in front. By integrating communication, these systems may adapt longitudinal control to the traffic in front. This leads to more natural following behaviour. Moreover, it helps avoiding accidents that occur due to the inattention of the vehicle in front. In the long term perspective, this includes platooning manoeuvres.

Two kinds of application have been developed to demonstrate this capabilities.

Early braking

The early braking scenario describes basically an extension to well known ACC applications. The basic idea is an early adaptation of the control strategy through the evaluation of the sensor information provided by inter-vehicle communication. Figure 15 shows a sketch of the intended demonstration scenario.

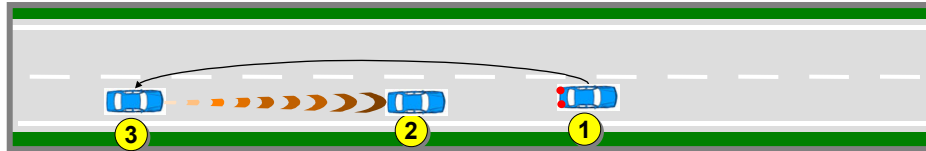

Figure 15: CBLC2 (Early Braking) Scenario

The demonstration scenario is comprised of 3 vehicles with the following properties

1. The first vehicle (numbered with 1) is equipped with communication capabilities and provides assisting functionality to the demonstration vehicle (numbered with 3). It transmits its position, speed, acceleration and lane information in certain time intervals.
2. The second vehicle does not need to be equipped with ACC and inter-vehicle communication. To assess the functionality of the CBLC system it is important that this vehicle (driver) adapts the speed to the car ahead (vehicle 1) in various ways (late or early).
3. Vehicle 3 represents the demo vehicle. This vehicle is equipped with a radar based ACC system and inter-vehicle communication. The communication facilities provide the capability to look beyond the front vehicle (vehicle 2) to improve the overall control strategy of the ACC system.

Such a set up shall allow to pinpoint the benefits of communication based longitudinal control. The assessment of the benefits and drawbacks of a communication based approach requires that the two approaches: ACC only and ACC with CBLC are compared on the test track. Therefore, the set up and test scenario shall be repeatable for an appropriate comparison of both concepts.

Stop & Go

Vehicles that are driving in the active mode automatically follow preceding vehicles with an optimised acceleration and deceleration strategy (active speed and headway control). Depending on the information of the vehicles ahead this can be a fast or slow acceleration and preferably an early, proportional and smooth deceleration (first by throttling and if necessary by braking). Since the functionality is mainly focussing on supporting the driver in congested traffic, the demonstration speeds is relatively low up to 50 km/h. Co-operative Stop and Go will go beyond the functionality of ordinary Stop and Go assistance

systems (that only sense the direct predecessor) by optimising longitudinal control. This scenario is less time critical than early brake warning and therefore emergency braking will not be demonstrated in this scenario.

Co-operative Driver Assistance (CODA)

A typical scenario for co-operation is an intersection situation. By exchanging information up to simple trajectory plans, critical situations can be foreseen and solved by the vehicles themselves. Another example would be highway entry and merging scenarios.

The scope of the CODA cluster was always the high-level cooperative support of driving assistance systems. As a minimal scenario, the basic merging of an incoming car on a freeway should be solved by the assistance function using cooperative AI concepts. Even within this limited scenario, most of the driving operations for freeway driving can be found already:

- **Distance keeping and speed management:** A car must be able to guarantee a safe distance to the end of the lane and to other cars, and must have a good strategy to adjust its driving behaviour accordingly.
- **Gap planning:** A car must be able to detect and verify a gap in the traffic that allows the car to change over to this lane.
- **Lane changing:** With a gap found, the car must be able to adjust its driving to reach and use this gap to change the lane.
- **Active cooperation:** In dense traffic, other cars must actively support a gap creation to allow the incoming vehicle to enter the highway.

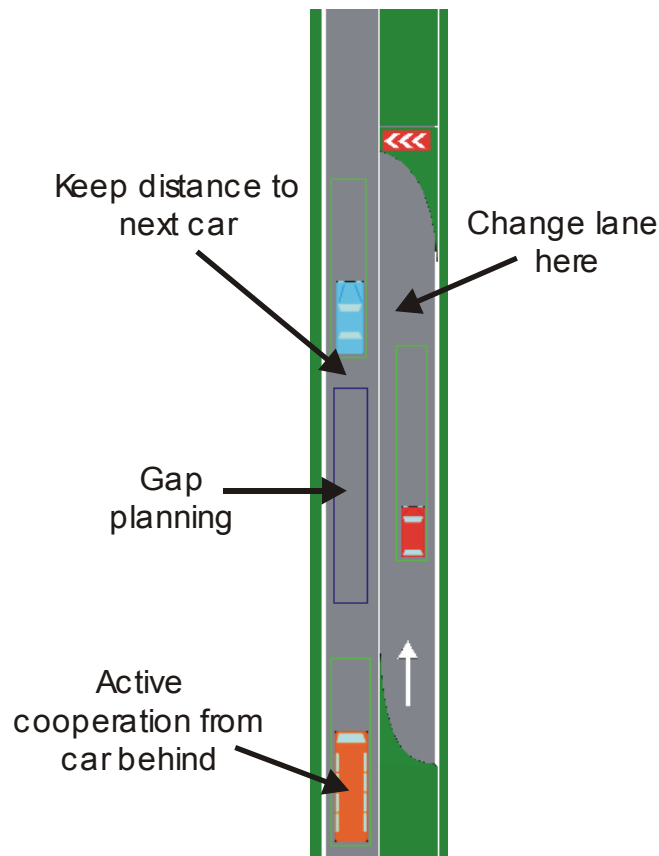

With all these important aspects already present, it was decided to expand the scenario view and to head for a general autonomous freeway driving system. The system should be well structured to allow the building of limited assistance systems, but to provide on the other hand a general architecture for autonomous driving systems, with special respect to safety, reliability and applicability. In the end, it does not make sense to develop a system that can perfectly solve a certain situation, but will fail if the scenario deviates only slightly from the specified situation. To avoid an overextension of the project, the intended scenarios are still limited to freeway traffic. The further problems of highway and city traffic, with oncoming and crossing traffic, intersections, various signs, traffic and right of way rules, pedestrians and a much more difficult road topology were considered to be too challenging to be achieved in one step.

Instead, a general freeway driving system was developed that can cope with any kind of freeway situations, is highly robust and reliable and is very flexible for system expansions, rule adjustments and usage for limited scenarios. The system uses an adjustable amount of inter-vehicle communication and cooperation and provides a basic structure for a wide variety of drive assistance functions.

Some of the achieved features are:

- Multi-level hierarchical system architecture for added safety and reliability
- Geometric planning instance for all kind of traffic scenarios
- Cooperative planning using future situation predictions

- Reduced communication effort by using implicit cooperation
- Applicability for scenarios with changing rates of unequipped cars
- Structural support for hazard detection and prevention
- Possibility to expand the system with specific rules for special situations

The resulting CODA system was implemented and tested using a specially developed software simulator. Testing in real traffic proved to require too much effort from supportive systems, but may be possible in the future.

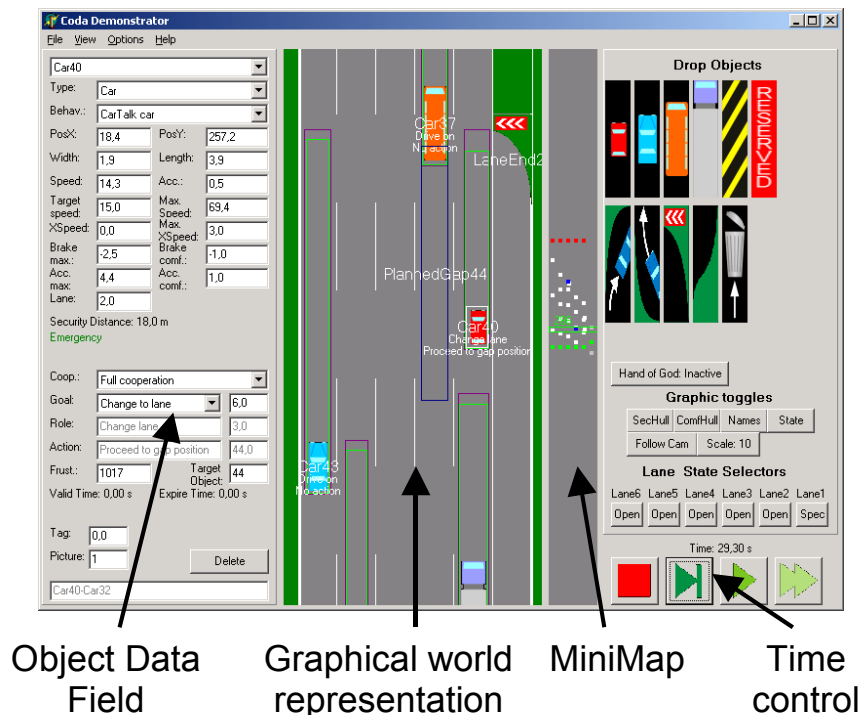

Figure 16: Description of demonstrator interface

Demonstrator vehicles

Six demonstrator vehicles have been realised during the project. DCA, TNO and CRF provided two prototypes each.

DCA vehicles

DCA demonstrator vehicles are a S-Class and an E-Class Mercedes.



Figure 17 – Demonstrator vehicle. Picture shows an alternative S-class demonstrator.



Figure 18 – GPS-antenna (left) and WLAN-antenna (right)

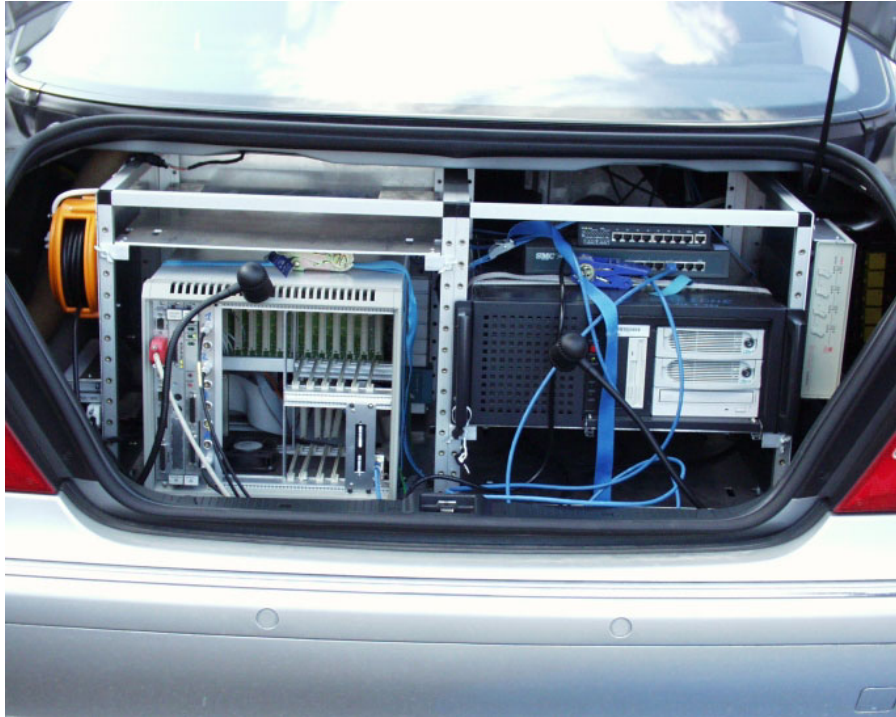

Figure 19 – Vehicle PC on the left and CarTALK application PC on the right



Figure 20 – TFT-Display for programming and debugging

TNO vehicles

TNO demonstrator vehicles are two Smart cars.



Figure 21 – TNO test vehicles



Figure 22 – Illustration of human machine interface



Figure 23 – WLAN antenna on roof of Smart

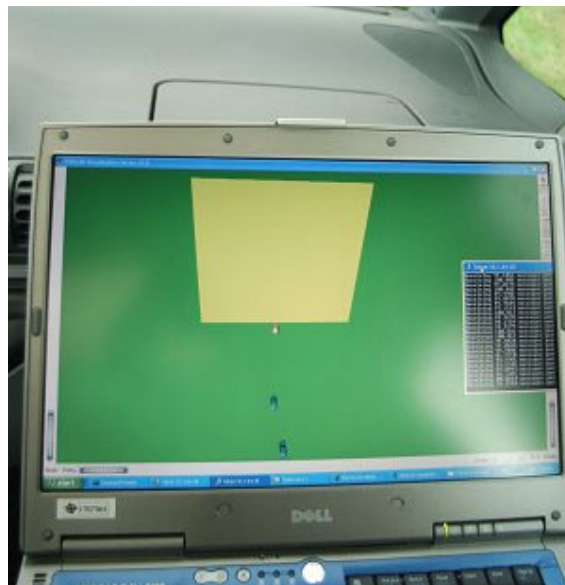

Figure 24 – Visualization of neighbourhood



Figure 25 – Integration of equipment in trunk of vehicle

CRF vehicles

CRF demonstrator vehicles are a FIAT Stilo Abarth and an Alfa Romeo 147.

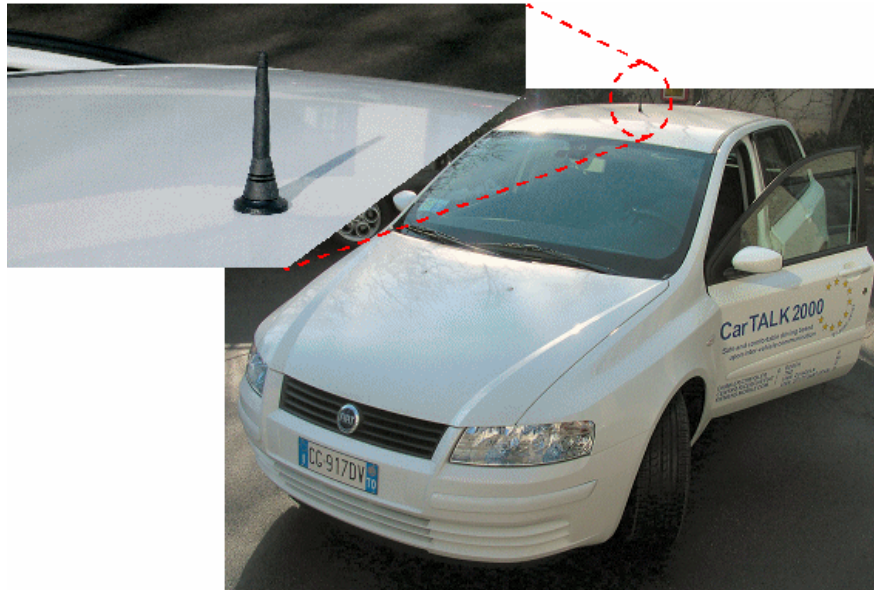

Figure 26 – CRF first prototype: Fiat Stilo Abarth



Figure 27 – Fiat Stilo: vehicle roof



Figure 28 – CRF second prototype: Alfa Romeo 147



Figure 29 – CRF second prototype: detail of the interiors

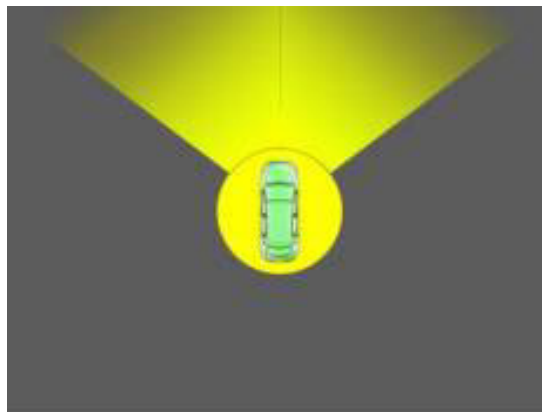

Figure 30 – Example of the on-board HMI

2.2 Safety Verification

2.2.1 Introduction

There are many systems on a vehicle that need to function correctly in order to maintain the safety of the traffic and other road users in general, and the vehicle occupants in particular. As a result of many decades of engineering experience, modern road vehicles and roadside equipment are safe and reliable products.

Additional engineering activities are needed, however, when a new safety system is included in the vehicle electronic and is introduced in the vehicle market. This issue is particularly important when systems are implemented whose functions can only be realized using programmable systems. Systems whose failure can result in a safety hazard are known as safety-related systems, and recommendations for their development in all industry sectors have been encapsulated in the standard IEC 61508 *Functional Safety of Electrical/Electronic/Programmable Electronic Safety-Related Systems*. This standard requires a preliminary hazard analysis and risk assessment to be performed early in the engineering development of a safety-related system.

The functions of CarTALK2000 are of such nature. The primary goal of the CarTALK2000 project is to design, test and evaluate co-operative driver assistance systems, based upon vehicle-to-vehicle communication, to improve the safety of all traffic participants. Many traffic situations or conditions create a hazard for the driver which could be overcome by a vehicle-to-vehicle communication system.

The functions are partly mere warning and information functions, and partly overrideable intervention functions.

All vehicles running more than 6 kilometres per hour can only be admitted to public road traffic in Germany, if they have received an official number plate and an operating road traffic licence. The vehicles equipped with a CarTALK2000 system, of course, also need to receive a formal approval by the German authorities (or European authorities).

IEC 61508 and the MISRA guideline give a detailed overview how a complete safety process would look like.

As part of the CarTALK2000 project only some aspects of the safety process are carried out. These parts are:

- a preliminary hazard analysis of the different function clusters,
- a analysis of the requirements of the communication system and
- a (short) safety verification of the whole system.

The results of these steps is shown in the following.

2.2.2 Preliminary Hazard Analysis

The Preliminary Hazard Analysis has shown that we have to differentiate between two main classes of hazards:

- Hazards which are not safety-related,
- Hazards which are slightly or highly safety-related.

The former hazards are not safety-relevant, however annoy the driver. In addition the driver must be always conscious about the fact that the system can have failed. If it comes too frequently to failures, the driver will switch the system off with considerable certainty. Moreover these errors are only in that case not safety-relevant, if the driver knows that he may not rely on the system. If the driver trust in the system without thinking about the possibility of failures than the system can cause additional accidents.

In the second case the hazards are safety-relevant. A failure can release accidents causally and lead to injured or even killed persons. These sources of error must be solved or at least become very improbable.

All functions which are directly acting on the brakes or the motor (or on steering) are "highly safety-related" or safety-critical. These functions must be implemented following a safety process. A Safety Requirements Specification has to be worked out; wherein for each possible single fault a measure must be identified or defined which prevents all road users from danger. Common mode failures have to be excluded, e.g. by an extended fault tree analysis. The core-system hardware cannot be built up using simple COTS (Commercial Off-The-Shelf) boards.

Many of the proposed measures are pure control measures. They try to have a good grasp to the arising hazards, so that its effect is no longer such critical. They are not avoidance measures, which have the goal to prevent the hazards at all. For technical and monetary reasons avoidance measures cannot be realised for all hazards. But this expenditure is urgently recommended in the case of safety-critical hazards.

2.2.3 Safety Requirements of the Communication System

As a result the requirements to a communication system on basis of UTRA-TDD are summarized. Not only the aspects on safety are dealt with, but also questions such as security and authorisation are handled. General requirements concerning safety and security and its relevance for the project CarTALK2000 was discussed. Moreover some aspects on Quality-of-Service in the contexts of MANETs were described.

It was not the goal to deliver a complete specification of the safety and security requirements but to give an overview of related aspects and to give some ideas what is important in the context of CarTALK2000 and what aspects are not of interest because of the special properties of the CarTALK2000 system. The report can serve as basis, if a system such as CarTALK2000 will be realised as a commercial product and will go to the market.

For the vehicle-to-vehicle communication the following safety measures are suggested:

In the physical layer first a CRC-16 code for error detection should be used. This CRC is a block code with a polynomial generator of degree 16 to calculate the redundant bits. The CRC has a Hamming distance of 3, so that the following capabilities are hold:

- 100% of all errors with an error burst length less than 16 are detected,
- 100% of all incorrect code words with up to 3 errors are detected,
- 99,998% of all code words with more than 3 errors are detected.

The error correction capability of CRC-16 should not be used.

If longer burst errors have to be detected we must use a greater polynomial. If more single errors have to be detected we must use a CRC with a higher Hamming distance by the use of BCH-codes.

On top of this, additionally a Convolutional Encoder/Decoder should be used for error correction. During this coding method a convolution operation is applied to the bit sequence of the messages and the CRC. With this operation additional redundancy is appended to the message. The convolutional decoder has a very good probability of correcting errors. It can be applied to the requirements with changing the constraint length and the coding rate.

The combination of convolutional coder and a CRC-16 leads to a very high probability of correcting errors or at least detecting remaining errors.

For messages which are not safety critical all the measures described are sufficient. Errors in these messages will not lead to critical traffic situations.

For safety critical messages some additional aspects have to be taken into account:

- An end-to-end CRC should be implemented. This will secure the whole path of the message. It must be implemented on the application layer.
- The overhead for error correction mechanisms is very high. Some simple or sophisticated re-transmission approaches for reliable messages can reduce that overhead. But they are very time-consuming.
- A good compromise between correction and re-transmission is an adaptive error correction, that increases redundancy if errors are detected.
- If re-transmission is needed anyhow, there is the problem that the sender may have left the Ad Hoc network already. A membership-protocol has to deal with this problem.

Additionally some requirements for security and QoS are mentioned but are not qualified in detail.

2.2.4 Safety Verification

The Top Level Hazards (TLH) of the CarTALK2000 system are:

- sudden and fast deceleration without reason,
- changing lane / entering a highway from onramp without gap in the traffic flow.

The safety relevance of the applications depends on these TLH.

The IWF functions, which simply give some information to the driver e.g. about the conditions or warn the driver, are only “slightly safety-related”.

The information output to the driver of the receiving vehicles must not distract or disturb them from driving or overload them by the information provided. Therefore, the design of the HMI has to meet the requirements of quick and reliable warning without giving rise to potential dangerous behaviour of the driver. The driver should be enabled to switch off a possibly faulty device.

Finally, it can be concluded that no significant higher risk arises driving with a IWF system as it does not intervene in main driving activities and leaves the complete and ultimate control over the vehicle with the driver. The driving of a vehicle equipped with such system does not become more dangerous by the use of the system than without such use.

Though the driver is responsible for his decisions and actions while driving the car, he must know about non-risky failures of the system and probably should know what to do or not to do in such situations. If one of the components has a total loss the driver must be informed about this by the HMI.

CBLC scenarios are divided into two categories – one is only warnings and the second is active assistance to the vehicle.

With regard to CBLC systems in a warning mode, the same admissibility aspects are to be considered as described above for IWF. The driver will be warned and it is in his decision what to do.

If the CBLC system is acting in the active assistance mode the case is more difficult. Systems directly acting on the brakes or the motor are “safety-relevant”.

The driver always has to drive carefully, he has to be attentive and has to hold a certain safety distance to the vehicle in front. In order to enable the driver to do this job, information and warning messages shall be issued even in active assistance mode and the driver must have the possibility to override and stop CBLC interventions at any time.

As a requirement of the first Top Level Hazards the brake interference of the CBLC system in active assistance mode must be limited to a value of 2-3 m/s² (compares to Distronic). Having such limited deceleration experience shows that following attentive drivers can react properly and in time. Moreover CBLC-braking shall be indicated by the brake lights as usual and the driver has to keep a certain safety distance.

It can be concluded that if brake requests are limited the value above and lights are activated by the braking system CBLC systems in active assistance mode are only slightly safety-related.

CODA scenarios are divided into two groups – one for only advisory and the second one for active control to the vehicle. The Top Level Hazards are not only braking without reason but changing the lane or entering the highway despite of the fact that there is no gap to enter the appropriate lane. These scenarios need not only reliable communication and co-operation. If this co-operation fails the traffic situation gets very dangerous.

Generally CODA scenarios depend on the availability of almost 100% equipped vehicles. Or the vehicle needs additional sensor technology in order to detect unequipped vehicles. Otherwise this kind of scenarios are of high criticality and shall not come in action in the real traffic. The number of wrong interpretations and wrong decisions is not predictable in case of to less equipped vehicles.

With regard to CODA systems in a advisory mode, the same admissibility aspects are to be considered as described above for CBLC. However, advisory in CODA-context is very different. If the driver gets a CODA request to decelerate or accelerate and enter the highway or to change the lane he/she is not in control of the hazards, like she/he is, getting CODA advice, where the hazards lie in front an in direct view. It is in the nature of humans (drivers) that they trust more in an advice than in a pure information or warning and that they follow this advice.

Because of unequipped vehicles, incomplete information of the environment and other corrupted or uncooperative vehicles the advise is based on vague data and may therefore be false.

Regarding CODA in the active control mode, some additionally aspects have to be considered. CODA in the active control mode means that the CarTALK2000 system gets the control over the vehicle until the driver explicitly override the system and gets back the control. Although the system might be overrideable from a technical viewpoint, special attention must be paid to the question whether the driver has enough reaction time to override the system.

Therefore, the system must be equipped with additional sensor technology, in order to seize vehicles, which are not equipped. CODA systems development must be carried out in a safety process according to an appropriate safety standard.

The drivers of vehicles equipped with CarTALK2000 systems must keep control over their vehicles at any time, regardless whether the system operates in warning/information mode or active assistance mode. The drivers are therefore generally responsible for safe driving, i.e. driving in accordance with the rules on public road traffic. This means that drivers shall not trigger unjustified warnings, for example by activating the warning flashers without reason. The drivers must also be alert to upcoming hazard and must not rely on warnings and information alone. In addition drivers must not overreact to warnings/information or a system intervention and must override the system if necessary.

2.2.5 Conclusion

If the CarTALK2000 system will get the admission it is of great importance to follow a safety development lifecycle. The measures which have to be carried out during a CarTALK2000 system development are different for the different functions especially between a pure warning system and an intervention system.

Especially the problem may arise that an intervention may - under certain circumstances - fail to appear where such intervention would be appropriate and is expected by the driver. In such case, the driver may refrain from taking the necessary action, in particular due to a loss of attention as a consequence of relying upon the system.

Although the systems might be overrideable from a technical viewpoint, special attention must be paid to the question whether the driver also has enough reaction time to override the system. It has to be shown by testing that drivers have sufficient reaction time to override a system in cases where this is necessary to avoid an accident.

Before the launch of a new product the manufacturer is obliged to assess carefully the product safety, if the new product is likely to bring about dangers, the manufacturer is obliged to develop new methods for risk analysis if such methods are not available. The more severe the danger expected is, the stricter the requirements, which the manufacturer has to fulfil. Since in public road traffic the life and health of persons are at stake, the standard to be met by a manufacturer is likely to be very strict. Therefore, the manufacturers of such systems will be expected to test CarTALK2000 systems on a broad basis before vehicles with such equipment are sold to drivers.

Hence, the manufacturer of CarTALK2000 systems are required not only to carry out standard failure detection procedures but to develop testing schemes in order to be able to assess the safety of the system, in particular with regard to HMI. Since the system safety widely depends on human factors (reaction to system warnings), testing procedures involving all relevant user groups are required.

2.3 Legal and Liability Aspects

The legal and liability aspects of introducing the advanced driver assistance applications foreseen in CarTALK 2000 have been assessed in cooperation with the Response 2 Project Report: "Legal and Liability Issues regarding Inter-Vehicle-Communication". We give here a short summary of the major aspects and results. The analysis is concluded as follows: "

- Vehicles equipped with CarTalk 2000 systems require admission to public roads as every other vehicle either under the provisions of the STVZO or by means of an EEC type approval. In this context, the design of the human-machine-interface is crucial in order not to distract or disturb the driver unduly, but to provide

clear and reliable information. Showing convincing testing results in regard of reliability and error frequency as well as a user profile, showing that overreactions are not likely, may help to overcome safety concerns.

- The drivers of vehicles equipped with CarTalk 2000 systems must keep control over their vehicles at any time, regardless if the system operates in an warning/information mode or an active assistance mode. The drivers are therefore generally responsible for safe driving, i.e. driving in accordance with the rules on public road traffic (STVO). This means that drivers must avoid the unjustified sending of messages, for example through activating the warning flashers without reason. The driver must also stay alert if there actually is a hazard and must not rely on warnings and information alone. Also, the drivers must not overreact to warnings/information or a system intervention and must override the system if necessary.

In this context a precise instruction of the drivers is essential as regards potential misuse as well as the description of functional limits of the system.”

Observing the StVO means that the driver is not allowed to reduce his attention from the road traffic or to rely on the system completely. Even if the system is equipped with an ADAS system the driver must be able and still has the duty to permanently observe the traffic. This obligation also remains for intervention systems, as the driver is obliged to overrule the system where the intervention is undue. Nevertheless, liability of the manufacturer cannot be excluded. This is shown in the analysis which continues as: “

- Liability of the driver regarding accidents in connection with CarTalk 2000 systems arises mainly in the cases of drivers misbehaviour identified above. For the sending driver a liability risks emerges especially from the activation of the warning flashers and thus the system without reason.

The driver receiving a warning/information faces an increased level of caution as soon as his vehicle is equipped with a CarTalk 2000 system and he has knowledge of a hazardous situation. Ignoring a message may even lead to liability for accidents that other drivers would not have been held liable for.

- Technical failures of the vehicle-based system leading to false information can establish the vehicles keeper's liability without regard to personal faults. Therefore, the process of data evaluation and processing and consequently the risk of mal-functions in the emitting vehicle has to be kept limited to the best possible extent.

- Regarding product liability, manufacturers of CarTalk 2000 systems and suppliers of components to the system might be liable under tort laws and product liability law. Liability under the latter requires not a negligent behaviour of the manufacturer but rather a defective product. Design, production as well as instruction defects are imaginable which might lead to liability.

Different from the strict liability under product liability law a liability under tort law requires a negligent infringement of a duty of care referring to the design, production, instruction or monitoring the

product by the manufacturer. Since the manufacturer must prove that he observed all relevant duties, which might be difficult in many cases, liability under tort law cannot be excluded.”

2.4 Socio-economic assessment

CarTALK 2000 applications give a significant contribution to the common objective to reduce traffic accidents. The main issue is to predict the safety effects of vehicle-technologies before the systems are on the market and actual accident data will be available, which was done with the socio-economic assessment.

In order to get a first impression of traffic impacts, pilot simulations were carried out covering one application from each cluster: basic warning function (BWF) representing IWF, early braking (EB) representing CBLC and basic merging (BM) representing CODA.

For the socio-economic analysis Basic Warning Functions (BWF) and Early Braking (EB) were selected as the most promising applications. Furthermore, both systems are quite inexpensive applications which can be regarded as add-ons (e.g. EB as ACC add-on). This enables system manufacturers to use standardized components as available in mass market production. The attainable economies of scale make it possible to realize low-cost applications with good perspectives for a broad market penetration.

An empirical relation between the output figures for BWF and EB production and the realization of economies of scale is not given. The empirical fact is, however, that the automobile industry and their supporting industries are well-developed industries in terms of technological productivity and economic specialization. The manufacturing of new technology systems within the automotive sector is thereby based on manufacturing expertise, R&D experience and a fairly skilled workforce.

The average cost curves in automobile industry for manufacturing vehicle components have in general a saucer-type shape that is, it is broadly U-shaped but has a flat stretch over a range of output.

Therefore it can be assumed that the decision to produce BWF- and EB-technologies depends strongly on the condition that the economies of scale are realized. With that the full economies of scale can be realized by an output corresponding to the lowest expected equipment ratio of 10%. The average costs of production then remain constant even the production is increased to the corresponding equipment ration of 100%.

The results of cost-benefit analyses for BWF can be summarized as follows:

- The benefit-cost ratio on the EU-level range between 1.16 (100% EQR) and 1.46 (10% EQR). Hence, introducing BWF is positive for the society. An investment of 1 Euro leads to a minimum social rate of 1.46 Euro.
- Although the average EU benefit-cost ratios seems relatively low, it has to be considered that there is a structural underestimation of accident numbers in the official databases. Adjusting the benefit-cost ratios by the average

underestimation of 1.3 indicates that then the benefit-cost ratios lie in between 1.51 (100% EQR) and 1.90 (10% EQR).

- The sensitivity analysis for the benefit-cost ratios shows that the maximal benefit-cost ratio indeed is reached for an equipment ratio of 10%. The reason therefore is the underproportional development of accident reduction related to the increase of the equipment ratio. However, it has to be clear that even a low penetration rate of BWF will give reasonable benefits to the society.
- The dominant benefit component is throughout the saving of accident costs. The capacity effect plays only a minor role.

For EB the results of cost-benefit analyses are:

- The benefit-cost ratio on the EU-level range between 1.14 (10% EQR) and 3.98 (40% EQR). Taking the underestimation factor of 1.3 into account the benefit cost ratios will change to 1.48 (100% EQR) and 5.2 (40% EQR). For the more unrealistic case of 100% equipment ratio EB will generate a benefit-cost ratio of 2.69. However, the results indicates that significant benefits for the society can be reached by a lower penetration rate, which is also more realistic.
- The sensitivity analysis for the benefit-cost ratios shows that the maximal benefit-cost ratio is 4.02 (adjusted 5.23) for an equipment ratio of 35%. The reason therefore is the underproportional development of accident reduction related to the increase of system costs.
- Like BWF the dominant benefit component for EB is also the accident cost saving. On average the accident cost savings have a share of 93% on the total benefits.

Due to these focuses of the CarTalk2000 project a reliable, trustworthy, verifiable and transparent cost-benefit analyses can be only undertaken for the usage of BWF and EB for passenger cars on motorways.

It is clear that both BWF and EB can be also used by passenger cars on other roads than motorways. That means the benefits worked out in the cost-benefit analysis represent that what can be reached by BWF and EB surely on motorways. The benefits, therefore, are a minimum value for that what can be expected by the society as resource savings.

The market introduction on the other hand considers the whole stock of passenger cars. That means that the costs determined within the cost-benefit analysis represent a maximum value. If now the benefits exceed the costs, there is a more valid proof that BWF and EB are desirable from a societal point of view.

An estimation of the benefits for the case that on all roads BWF and EB is used gives a number that is only a reference point. Considering these possible additional accident cost savings on

rural and urban roads the CBR increases for both BWF and EB. The cost-benefit ratios for BWF lie in between 4.3 (EQR=40%) and 5.2 (EQR =10%), for EB the cost-benefit ratios range between 2.7 (EQR =10%) and 9.1 (EQR =40%).

Finally it can be stated that both systems, BWF and EB, are desirable from a societal point of view. They lead to significant benefits by reducing accidents. For both system the difference between benefits and system costs increases with a higher EQR.

- For BWF the surplus ranges in between 11 Mill. € (EQR=10%) and 41 Mill. € (EQR=100%).
- The surplus for EB increases from 6 Mill. € (EQR=10%) up to 653 Mill. € (EQR=100%).

That means that a full market introduction of EB and BWF is favorable, because with that it is also possible to generate additional benefits by avoiding accidents on urban and rural roads. Considering those types of roads lead to following surplus of benefits:

- BWF creates a surplus of benefits over system costs of 111 Mill. € to 843 Mill. €.
- The benefit surplus ranges from 65 Mill. € to 1.9 billion €.

These figures point out that the technical functioning of BWF and EB should not be limited to motorways, because their workability on the total road network promises enormous resource savings for the society. And that proves that from the transport policy standpoint BWF and EB present optimal technologies for reducing road accidents.

However, the market introduction of EB is limited, because EB is an add-on to ACC. Therefore, the market prognosis of ACC is relevant, which, unfortunately, indicates a low market penetration rate in the next decade. However, BWF can be introduced as stand-alone solution like ESP into the market. If BWF is introduced market penetration rates on average between 24% and 35% sound realistic.

The decomposition of economic benefits to different stakeholders (public obligatory insurances, society and government administration, accident victims and private insurance companies) showed that the cost savings realized by private insurance companies should be re-allocated to the system users, because then the profitability of BWF and EB will be significantly increased.

The automobile industry itself is a key industry for the European economy. The calculated system costs for BWF and EB, therefore, can be seen as additional investment of the automotive sector. Due to the low system costs the additional investment will play a minor role compared to the overall investment of car manufacturer, however, on average additional employment can be expected in a range of 1,800 to 28,000 additional jobs.

The low system costs for BWF and EB indicate minor macro-economic benefits, but the low system costs are evident for the

vehicle driver, because they meet the general market acceptance and will ease a market-covering introduction.

2.5 Standardisation and market introduction

Car manufactures are actively looking for a communication technology which can satisfy all Vehicles Driving Assistance application requirements and it can be expected that such communication system will become **standard equipment in all future vehicles**. Below some information about input to standardization bodies and potential market introduction are given.

2.5.1 Input to Standardisation

As explained in D6 and D9, the UTRA-TDD radio technology was born as centrally organised UMTS system, so they need to be replaced by CarTALK 2000 protocols which will enable operation in distributed ad hoc mode. In CarTALK 2000 system a centralised reference is missing and the distinction between downlink and uplink doesn't exist. As a consequence, many of the characteristics of the UTRA TDD physical and data link layer have to be carefully revised in order to understand the new requirements.

The UTRA-TDD is standardized in the 3rd Generation Partnership Project (3GPP) which is a collaboration agreement that was established in December 1998. The collaboration agreement brings together a number of telecommunications standards bodies which are known as "Organisational Partners". The current Organisational Partners are ARIB, CWTS, ETSI, T1, TTA, and TTC. The original scope of 3GPP was to produce globally applicable Technical Specifications and Technical Reports for a 3rd Generation Mobile System based on evolved GSM core networks and the radio access technologies that they support (i.e., Universal Terrestrial Radio Access (UTRA) both Frequency Division Duplex (FDD) and Time Division Duplex (TDD) modes). The scope was subsequently amended to include the maintenance and development of the Global System for Mobile communication (GSM) Technical Specifications and Technical Reports including evolved radio access technologies (e.g. General Packet Radio Service (GPRS) and Enhanced Data rates for GSM Evolution (EDGE)).

Using UTRA TDD in ad hoc mode, we would like to maintain as far as possible the major characteristics of this system, but some changes are needed. In particular the adaptation of the new ADHOC MAC protocol (proposed by SMC in CarTALK 2000 and on which SMC has a patent pending) over UTRA TDD physical layer, implies the need of a completely new Data Link Layer (DLL) design. A preliminary description of a DLL architecture has been provided in chapter 5 of deliverable D9. It is worth to evidence that all consideration done regarding DLL architecture has been kept general and related in particular to the specific requirement of CarTALK 2000 project. Further optimization may be foreseen in order to improve the performance or according to specific requirement of further possible applications.

From a general point of view the deliverable D9 shows the need for improvements to existing the communication standard selected as a target (UTRA TDD). From this, we can conclude that the proposed concepts represent a significant and valuable conceptual base to start the process leading to a future standardized communication system.

The preparation of a specifications document useful as basis for future standardization, identification of future standardization strategy (joint communication/automotive manufacturers strategy), then should start from deliverable D9.

In order to standardize the new features of UTRA TDD system in the 3GPP standardization body, the following procedure has to be referred to. A new Work Item (WI) related to the interested issue has to be submitted to the correspondent 3GPP TSG (Task Specification Group). After the approval of the WI by the plenary, contributions are collected in a first technical document, called Technical Report (TR), which constitutes a base for further discussion. When the TR reaches a definite and exhaustive status it can be converted into a new Technical Specification (TS) or it can update an existing one. The standardization process requires a long 3GPP official iter and needs to be supported by the agreement between the telecommunications companies and major interested supporters in the issue, in this case, world-wide cars manufacturers. Hence this require a clear commitment (that is not defined yet) from communication/automotive manufactures.

The possibility to standardize the UTRA TDD in self-organizing mode in 3GPP is only one opportunity, but the whole system could be standardized in other standardization bodies like ISO, and especially when it comes to vehicle-specific standardization like EUCAR and C2C-CC (see below).

In the Deufrako IVHW project's co-operation of Daimler Chrysler, Renault, PSA and Bosch, the technical concept of an Inter Vehicle Hazard Warning system has been developed, focusing on European availability, easy vehicle integration, simple but relevant use-cases and technology which is available even today. The successful agreement of the consortium covers the message content, use-cases, overall technical concept philosophy as well as using SRD at 869,4 – 869,65MHz for data communication. Driven by Daimler Chrysler's initiative and with the knowledge and experiences shared with the CarTalk project, the technical concept has been introduced to the EUCAR SGA (European Council for Automotive R & D; Steering Group Advance Control), inviting all European car manufacturers to assess the concept and to participate the further work in standardisation. It is of great significance, that EUCAR officially responded with the substantially acceptance of the system concept by all European OEMs.

The results and the technical concept of Deufrako IVHW have been shared with the Cartalk2000 consortium. The discussion with its experts in data communication, system engineering as well as in socio-economics has shown no obvious contradictions. This is a success as it indirectly supports the standardisation of IWF with the experts knowledge of CarTalk2000.

The decision to take WLAN into account for the demonstration system and further analyse possibilities for this technology even as an option for market introduction came rather late in the project and not all preparations and basic actions for a standardisation have been able to consider in this short timeframe. Nevertheless we want to emphasize the following:

In general, the strategy for standardization of vehicular WLAN possibly differs from what is expected from us. We believe that the consortium within the CarTALK project was a quite good starting point but before formal standardization we must address a broader interested audience of car manufacturers and suppliers. This prevents that something is being standardized but never used.

That is why we actively started the Car-to-Car Communication Consortium (C2C-CC). Besides the car manufacturers from CarTalk, DaimlerChrysler and Fiat, BMW and VW/Audi have already joined. More car manufacturers and suppliers are expected to join soon.

Our strategy is to consolidate our findings from various company internal, national and European projects before making a joint effort for a C2C-CC internal standardisation and then finally a formal standardisation. Additionally we exchange our ideas and findings with the US counterparts (Vehicle Safety Consortium, VSC). Our first goal but also the major challenge of C2C-CC is to get a dedicated frequency band for exclusive use with safety-related vehicle applications. This allows not only to achieve a high level of reliability and predictability for the applications but also to have really all further efforts on communication systems and their standardisation within a defined standardised frequency framework. Note that this strategy is similar to what already happened in US. We are convinced that with support of the European funding we are in front with the technologies developed but we have to move on to avoid being at the back of market introduction compared with the US because the legal conditions for getting a dedicated frequency band might be decisive and seems to be more complicated in Europe.

For the formal standardization we are in touch with the ISO TC 204 which addresses the standardization of information, communication and control systems in the field of urban and rural surface transportation, including intermodal and multimodal aspects thereof, traveller information, traffic management, public transport, commercial transport, emergency services and commercial services in the intelligent transport systems (ITS) field. We are strongly interested in formal standardisation and will push to start that at the appropriate time. We think the appropriate time is after we reached an industry standardisation within C2C-CC.

2.5.2 Potential market introduction

The future evolution of mobile communication for inter-vehicle communications is quite hard to predict exactly and it will clearly depend significantly on external influences like they come from local regulation, availability of hardware radio technologies and the communication/automotive manufacturers strategy.

With respect to the status of UTRA TDD hardware in self-organizing mode, Siemens has a concept for a prototype but the business case also depends on the success of cellular UTRA-TDD low chip rate option system (TD-SCDMA). Currently the success seems to look quite good for the cellular UTRA-TDD (TD-SCDMA) in China. In fact TD-SCDMA@GSM (TSM) is standardised in CWTS (China Wireless Telecommunications Standard) and from the Release 4 of 3GPP specification the UTRA TDD-LCR, selected as target system in CarTALK 200 project, is admitted. Some trials are in progress in some different cities in China. Considering the strong interests addressed, some important companies are involved in the development of TD-SCDMA network equipment (e.g. Siemens, Alcatel, Fujitsu) and user equipment UE (e.g. Nokia, Texas Instruments, Philips, RTX Telecom). As for the user equipment, a TD-SCDMA test terminal composed of two devices (Compaq iPAQ PDA 3850, TD-SCDMA expansion jacket with full hardware and software integration) has been available for field trials.

The support, development and usage of UTRA TDD technology for inter-vehicle communication represents also an opportunity to enforce and further exploit ongoing development activities of TD-SCDMA systems with new application scenarios and, in particular, an opportunity to support the introduction and spreading of this technology in Europe. However, as for the standardization process, the UTRA TDD (for inter-vehicle communication) market introduction requires a clear commitment (that is not defined yet) from communication/automotive manufactures.

Anyway car manufactures are actively looking for a communication technology which can satisfy all Vehicles Driving Assistance application requirements and it can be expected that such communication system will become **standard equipment in all future vehicles**. They are potentially extremely interested in inter-vehicle communication systems (e.g. UTRA TDD), as demonstrated by the participation to CarTALK 2000 and other research projects with the same topic. Besides this research initiative, these car manufacturers are heavily involved in creating forums, e.g. EUCAR, which serves to coordinate the European pre-competitive activities in the field of telematics and has been founded in May 2002, VSC (Vehicle Safety Communication Consortium) founded also in May 2002, which serves to facilitate the advancement of vehicle safety through communication technologies in the USA, and the C2CC (Car2Car Communication Consortium) for specification of an industrial standard for an open inter-vehicle communication platform and for basic safety applications, which has recently been founded in May 2003 in Germany. In particular, C2CC (DaimlerChrysler, BMW, VW/Audi, and Fiat) is a non-profit organization addressing communication issues between vehicles and roadside infrastructure components. The targeted results are the specifications required for standardization as well as the implementation of a demonstrator

as proof of feasibility. Basis for the development of the European industry standard is the openness of the Car2Car Communication Consortium to new interested members.

2.5.3 Basic problem for getting vehicle-vehicle communication into the market

In opposite to autonomously working safety systems like airbag, ABS or ESP, vehicle-vehicle communication requires at least one communication partner within the communication range. Therefore the introduction is more difficult as the system may not develop its benefits at once but only on a progressing penetration rate. The following market introduction scenarios aim for IWF to provide clear benefit for the very first customer paving the way for an increasing penetration rate. IWF will open the public to the obvious advantages of vehicle-vehicle communication enabling technologies for the advanced CarTalk2000 applications with their more demanding requirements.

2.5.4 Equipping police and ambulance vehicles, service cars of automobile clubs

Basic idea, advantage

Police and ambulance vehicles are being equipped with the vehicle-vehicle communication system. At the hazard location the vehicle's driver initiates the transmission of IWF messages. So approaching vehicles with the vehicle-vehicle communication system will be notified even if the vehicles causing the accident are not equipped ones. For the IWF market introduction police and ambulance vehicles act like a multiplier.

Additionally, service cars of automobile clubs like the German ADAC may be equipped with the vehicle-vehicle communication system. Service cars support drivers which technical assistance for example in case of a vehicle breakdown. The service technician may easily decide if the situation is critical to approaching vehicles and initiate the transmission of IWF messages.

As the vehicles are part of a "closed user group", usage, target area and technical characteristics of the vehicle-vehicle communication system may be easily controlled. Additionally there is supposed to be no misuse of the (manually activated!) system by those users. The success of the vehicle installation may be tracked and determined as passing equipped vehicles could respond with a type of "Acknowledge IWF message".

Potential

In year 2003, the German police has registered

- 101 446 accidents out of urban areas (except highways)
- 22 590 accidents on highways [1].

Assuming that most of those accidents are recorded by the police at the spot, there is a potential of approx. 340 accidents a day where a police or ambulance vehicle is called to.

The "ADAC-Strassenwacht" owes 1700 service vehicles which a daily mileage of 150.000km. [2] This potential should have to be investigated more detailed as it is assumed that the major part of it is addressing the urban area which is not relevant for IWF.

2.5.5 Equipping road works with IWF beacon

Basic idea, advantage

Road works on highways are distinguished between

- Long-term roadworks

Usually linked with speed reduction and closed lanes for example for reconstruction of bridges and surface. Although being announced by road signs a few hundred meters in advance, unaware drivers may cause dangerous situations with rear-end collisions due to rapid speed reductions at the very beginning of the affected section. Due to closed lanes ("bottleneck") congestion of traffic may develop also causing the potential danger of rear-end collisions.

- Short-term roadworks

Linked with speed reduction for example for maintenance of road signs and cutting of bushes and grass. In opposite to long-term roadworks the affected section is usually announced not so much in advance or even just a few meters on slow moving roadworks also causing a certain potential danger to the approaching vehicles and the workers.

The basic idea in both cases is to place a transmitting IWF beacon at the beginning of the affected section transmitting the actual position and additional information like speed limits. With a communication range of approx. 1000 meters drivers will be notified in advance by their vehicle-communication system. It may be assumed that even unaware drivers have enough time to react accordingly to the situation. The IWF beacon may also have a simple one-button SOS function enabling the workers to put additional information in the IWF message in case of an accident within the affected section. On slow moving roadworks the beacon would simply move together with the roadworks vehicles.

Potential

A simple inquiry performed in April 2004 indicates the huge potential for equipping long-term roadworks on highways in a few districts of Germany:

Nordrhein-Westfalen:	120 roadworks on highways
Niedersachsen:	31 roadworks on highways
Hessen:	20 roadworks on highways
Bayern:	90 roadworks on highways

2.5.6 Equipping Set Of Lights with IWF beacon

Basic idea, advantage

Indicating actual and variable speed limits, dangers like fog, slippery road or accidents, those road signs are usually connected to some kind of intelligent signal processing unit to detect traffic flow rate at the spot or to a traffic control centre.



As specific information about the visualized conditions are already available it would be very easy to transmit it to approaching vehicles. The electricity is also already available and could supply the IWF beacon.

2.5.7 Support by Insurance Companies

Basic Idea, advantage

For risk reducing factors, insurance companies offer their customers a reduction of the insurance premium for example if the car usually being parked in a garage. As vehicles equipped with an IWF system have a significantly lower risk of getting damaged in an accident, a reduction of the insurance premium seems to be obviously possible. This could be an incentive for a driver to equip his vehicle with an IWF System.

Nevertheless, this seems not to be applicable as our investigations shows. During a demonstration of the Bosch IWF System "WARN", a representative of the German HDI Insurance company has stated, that a reduction of the insurance premium in advance is not possible. Although being convinced about the positive effect of the IWF System, the system has to prove worthwhile for a certain time in use. Only after evaluation of the herein gained results, a reduction of the insurance premium may be considered. This implies that the market introduction already has to be successfully completed.

What makes this idea even more questionable is the problem of accident costs. Our applications are designed to avoid or mitigate harm to persons and especially to avoid fatalities. For example consider that designing a "safe" emergency braking system is more likely to come into market if it only triggers an automatic emergency brake if an accident is unavoidable. This is because with such a system OEMs may face less legal questions in case of malfunctions like emergency braking in situations where not

braking or later braking or softer braking would result in less injuries to the driver or to driver of following vehicles. This means the system only mitigates the accident consequences, not the accident itself. Having such a system in mind – which undoubtedly can save lives - it becomes unclear whether it really saves costs for insurance companies. Our socio-economic assessment has shown that in certain situations, where a fatal accident is avoided but the injuries are quite severe the insurance company costs are higher than with a fatal accident.

As a result, the support by insurance companies is less likely than it seems at first glance and could only happen after the system has proved its positive monetary effects for some time and in real systems on the road.

Potential

Only limited prospects as explained above. As they refuse ex-ante premium reductions because they do not rely on potential savings, they require ex-post proven reductions of accident frequencies and severities. This means, support of insurance companies is unlikely to improve the introduction.

2.5.8 Support by value adding services, Hot spot advertising

Basic Idea, advantage

Hot Spots, for example at gas stations, Drive-In Restaurants, Entry/Exit of car parks are equipped with a high data rate wireless communication system. The driver, entering the Hot Spot area, gets free downloaded multimedia content like MP3 music files or game applets. Obligatory, electronic advertisement will also be downloaded and presented to the driver. By this advertisement the technology for the Hot Spot itself as well as the vehicle communication system could, at least partially, being financed. With an increasing market penetration rate, the communication system, which has up to now being used only for downloading the multimedia and advertising content, is enabled to take over functionality for the vehicle communication.

Potential

In Germany, more than 2000 Business Hot-Spots are already online by April 2004 with an increasing tendency [4]. A study, carried out by Frost and Sullivan, assumes that more than 20 Million Europeans will be using Hot-Spots WLAN access by the year 2006. CarTalk 2000 could participate in this development as cost for the WLAN hardware will further be decreasing and the demand will grow of getting WLAN access also in vehicles.

2.5.9 Introduction Strategy

At present two different technologies are the major possible candidates for wireless vehicle communication: WLAN (Wireless Local Area Network) and SRD (Short Range Device) because both are already available in contrast to UTRA-TDD technology. The

future development of UTRA-TDD under technological and economical aspects is hardly predictable as it may be assumed that providers will focus on the construction of the UMTS net and its basic services first. Therefore it is not considered in the introduction strategy.

After giving a short overview on the pros and contras of WLAN and SRD, the introduction strategy of CarTalk2000 applications on a two-step model will be explained. It is highly related to communication aspects influenced by the penetration rate and the complexity of the overall system.

Pro/Contra WLAN

WLAN provides in general a much more higher data rate than SRD. Mainly driven by a high volume consumer market, WLAN will progress in technological as well as in economical aspects: Even higher data rates, secure data exchange, enlarged communication range as well as lower prices. Driven by a growing number of WLAN Hot Spots in the US but also upcoming in Western Europe we experience a growing interest in using WLAN for vehicle communication. It might be important to point out that WLAN has the ability to converge the consumer world and the automotive world. Besides the car-to-car communication WLAN would provide additional benefits like connection to consumer devices or hot spot Internet access without additional costs for the customers. It might even be the case that customers buy WLAN systems for their cars because of entertainment purposes at top priority and they get additional car-to-car communication safety system for free.

WLAN faces some drawbacks.

Although the communication range for vehicle communication has been found out to surprisingly some several hundred meters, good results require certain conditions like line of sight communication. It is assumed that weather will have a certain negative influence as being nature of all high frequency radio communication systems. Data link control is a limiting factor as some time is necessary to establish the communication session which limits the amount of transferable data before the communication partners get again out of the communication range. But it may be assumed that this issue will be improved in upcoming WLAN standards and perhaps standards in particular designed for car-to-car communication. A dedicated antenna is necessary as a GSM antenna may not be shared due to the different frequencies. In foreseeable future, the major part of the vehicles will not have the necessary on-board infrastructure to directly interface with WLAN equipment as used in non-mobile networking. Also, the data processing power, which is necessary for WLAN multi-hop systems, is not available in current vehicle equipment.

Pro/Contra SRD

The term "Short Range Device" (SRD) is intended to cover radio equipment providing uni-directional or bi-directional communication and which has low capability of causing interference to other radio equipment. Non-specific Short Range Devices are used for telemetry, telecommand, alarms, data and other similar applications [5].

Using the SRD frequency band 869,4 – 869,65MHz has some major advantages. Due to the long-range communication zone of approx. 2km no data hopping is necessary which strongly simplifies the overall IWF system. Highly integrated communication systems are available at quite low costs as SRD profits of many manufacturers with radio chips for a high volume consumer market. Radio modules are easily integrateable into Car HiFi or navigation systems like analog or digital receivers already are. Car HiFi or navigation systems would be the ideal "carrier" of an IWF system as many system components like GPS, access to vehicle signals e.g. using CAN bus and an HMI are available. Additionally, the channel of distribution is already existing. As data hopping is not required, data processing power is low and manageable of today's on-board car equipment. The SRD frequency band offers license free data communication in the harmonised 869,4 – 869,65MHz band within almost all European countries. A big benefit is the ability of sharing the GSM-Antenna of the mobile phone which also reduces system and installation costs as well as simplifies the work of the car designers. It also should be mentioned that in the EUCAR SGA (European Council for Automotive R & D; Steering Group Advance Control) an inter vehicle hazard warning system has been proposed and substantially accepted by all European OEMs using the SRD band 869,4 – 869,65MHz.

SRD's drawbacks:

Usually, SRDs use frequency bands already allocated to other services and generally cannot interfere with nor claim protection from these services. However, this should have just minor impact as IWF systems are mainly being used in rural region and it may be assumed that there are less other SRD services.

The data rate is much more lower than using WLAN. So, reception of some kind of multimedia content, which is one of the market introduction scenarios, is not possible. It is not reasonable to use SRD with its low data rate for multi-hop communication, either. With SRD it is unlikely to have a symbiotic use with other information and entertainment applications because the consumer market will concentrate on WLAN.

Proposed CarTalk2000 introduction strategy

In the previous chapter, market introduction scenarios have been given which provide clear benefit for the very first customer. To

improve traffic safety further on, more and more vehicles need to be equipped.

For the market introduction, two factors are of major impact – both are influenced by the choice of the communication technology:

- direct system costs, mainly influenced by the choice of electronic components etc.
- indirect system costs, mainly influenced by the integrateability of the system into the vehicle equipment.

As derived from the pros and contras of WLAN and SRD, using SRD has an cost advantage over WLAN as illustrated:

Communication technology	direct system costs	indirect system costs
WLAN	+	-
SRD	+	+

Due to the higher costs, using WLAN would result in a slower penetration rate. It would affect the overall system function as WLAN has anyhow a smaller communication range than SRD. On the other hand, the costs of WLAN can possibly be shared with other applications for entertainment purposes or consumer device integration.

Nevertheless, for the joint project introduction strategy we decided to choose a two-step model of CarTalk2000 applications starting with SRD and enhancing it later with WLAN. Note that company individual introduction strategies may vary as will be described in the eTIP.

Introduction of Information and Warning Functions (IWF) using SRD

A SRD communication module will be available for integration into Car HiFi or navigation system, directly on the system's printed circuit board or as a separate box which will be connected to the Car HiFi or navigation system using a standard vehicle bus, e.g. CAN bus. The communication module will benefit of low prices from the SRD consumer market with a high volume of transceiver chips, tuned to meet automotive requirements. By a signal splitter, the communication module is using the same GSM antenna as the car's mobile phone. Thus, the car design, which is one key factor of "best sellers", will not be affected. Transmitting and receiving of data will be managed autonomously by the communication module. The long ranging data communication enables a non-hopping system, even under no line-of-sight conditions or heavy showers and at a (still) low penetration rate. As no data hopping is necessary, the hardware and software requirements for the new feature "Information and Warning Functions" are quite low and may be managed by today's vehicle infotainment systems. As being integrated into that already well known systems, IWF appears to the customer seamlessly as a new feature. Also, the

distribution channel is already established, so IWF may be ordered from the car manufacturer's accessories list or in a supermarket.

At the beginning, the system improves traffic safety mainly by the infrastructure based "multipliers", like police and ambulance cars as well as beacons on highway roadworks. As more and more vehicles are equipped, a rolling fleet of sensing vehicles is being created, transmitting information about sudden incidents and crucial situations in the very surrounding. Customers experience some kind of Aha-effect, as they are being notified about a dangerous situation even before being able to realise it with their own sense. As the customer's response in IWF increases, so does the general interest in vehicle communication and the penetration rate, paving the way for the next generation of CarTalk2000 applications.

Introduction of WLAN for information and entertainment and additionally Information and Warning Functions (IWF)

It might be questionable for a reader whether it is wise to introduce with WLAN a second communication technology for the same purpose of our CarTALK applications. However, in the long run we see with a vehicular WLAN derivative which is compatible to consumer WLAN technology the decisive strategic advantage that it will come with very low costs. Or even better, if WLAN is integrated in vehicles first and foremost for information and entertainment functions, it will be for free if additionally used for CarTALK applications.

This means, based on the vehicle manufacturers market assessment the consortium believes that WLAN will be integrated in vehicles as it is today integrated in personal computers, laptops, digital media players and even digital audio players. The main applications in mind are information and entertainment applications, like:

- Hot spot Internet access (data communication)
- Hot spot information access (traffic information, perhaps safety related information over hot spots)
- Special value added hot spots at dedicated places like gas station, car parks, etc., with probably free-of-charge access but tolerated advertising
- Consumer world connection (connection to consumer world like digital audio players, laptops, upcoming WLAN enabled mobile phones, etc.)

Currently, the Bluetooth technology experiences a similar broad inclusion in vehicles. Because WLAN proposes much more applications than Bluetooth, which is mainly suitable for telephony, its vehicle integration will be quite sure within the next years.

These information and entertainment applications coming with WLAN will be integrated for a reasonable optional price, because even current WLAN technology is available for less than 20 € and its price will fall strongly in the next years, or it will be even integrated without optional price for the customer if its functions become a commodity. At least for medium-sized cars and the

luxury segment even the initial integration seems likely to be for free for the costumers. This grants for fast integration and high penetration within less than 2-3 years.

Our prospected WLAN introduction scenario so far has not included safety related applications like IWF. This was done with full intension because having an introduction scenario which does not rely on IWF means that we do not have to bother about the penetration problem and the advantage for the first buyer. This means, the first buyer has its advantage from the information and entertainment functions. Later, when the penetration rate is sufficient, our costumers can additionally benefit from IWF functions without additional costs. We think this will then be the right time that SRD will be replaced by WLAN technology or if SRD will not spread, this will be the time when IWF will spread into the market.

Enhancement and enrichment by communication-based longitudinal control systems co-operative assistance systems based on WLAN

More enhanced applications like CBLC and CODA will only be based on WLAN. This is because when introducing these applications WLAN will have a sufficient penetration rate and because for such applications we require the higher bandwidth available only for WLAN.

It is difficult to predict a concrete introduction scenario for these applications. To be realistic, the legal and liability problems are still quite severe such that a short-term introduction of them, especially when it comes to fully autonomous functions even for steering, is quite unlikely.

Nevertheless, we see a huge market potential of what we developed in CarTALK if we put back the full autonomous operation in favour of assisted operation. We prospect that these function will first be introduced as mere information applications assisting the driver. For example, we envisage that we will have assistance functions that help us in certain driving situations. For example, an assistance function could guide us for the proper speed when changing to another lane or merge with another lane. Other systems could guide us at intersections, where an enormous fraction of all accidents today happen. Such assistance functions could come into the market within a 6-year period (we need 2-3 years for our initial IWF applications and then 2-3 years for having enough penetration for such assistance functions).

The next step would be to introduce CBLC functions. Communication-only CBLC functions will unlikely be introduced because they require 100% penetration rate which we never will be able to guarantee. However, communication-based CBLC combined with already existing local sensor-based systems like the Mercedes radar-based Distronic and shown in the CarTALK projects with the Mercedes demonstrator have a huge potential for market introduction. We proved with our demonstrators that they provide significant benefits over systems based on local sensors only. In combination we can benefit from earlier and better traffic predictions by incorporating not only the direct vehicle in front but the whole vehicle convoy in front, and have still a very reliable

system which can operate stand-alone by relying on its local radar-sensor.

2.6 Dissemination

The CarTalk 2000 project consortium has published its results in more than 20 scientific papers (journal and conference proceedings) and presented its results on more than 30 workshops, conferences, other projects or consortium meetings, or journals so far. Regarding the applications works package and the socio-economic assessment - both have been finished at the end of this project - more publications after the official project end are expected because results are available from now on and earlier publications would have not been plausible.

Besides the scientific dissemination, the project was active in sharing their results and ideas with other national and European research projects like FleetNet, INVENT, IVHW, GALLANT, ADASE II, RESPONSE and others. Of particular interest is that new started projects like the European PREVENT and its subproject WILLWARN or the national NOW project got support and help for their architecture and overall approach from CarTalk 2000, e.g. by sharing deliverables, sharing ideas and discussions during the project proposal phase, and attending the kick-off meetings.

The project has lead to three patent applications in the area of communication technology and its applications' so far.

The project has been present at ITS 2003 in Madrid with a booth showing a CarTalk 2000 poster, a CarTalk video, and computer presentations and brochures.

At the final workshop and demonstration in July 2004 the project opened its results to a broad audience.

The consortium has also spread its results to start and contribute to on-going standardisation activities (see section before for details).

3 Lesson learned and future developments

3.1 Lessons learned

The CarTALK project was a typical vertical project. This means it covered a large range of technologies, studies, and methods. For example it started from the physical communication layer, discussed the link layer, routing layer, transport layer, and application layer. Applications have been developed. Security and legal aspects have been taken into account. Most technologies have been integrated into the demonstration vehicles. Such a vertical project is pretty impressive because the achievements are pretty clear. And such a vertical project is interesting because it brings together people and companies from different fields like engineering and legal system.

It is often the nature of public funded projects that they are vertical projects because the advantages mentioned above are what the financier want to stimulate and realise. But it also means that some of the technologies cannot being investigated in that depth which would be preferable by some of the partners or even for the whole project. From an engineering perspective, at least two large fields require more attention in future projects. One field is the communication protocol and its standardisation and the other field is the application definition and its standardisation.

Although the project spent a significant share of the budget on communication protocols and standardisation and actually achieved remarkable results, this task is still not completed. The main reason for this is because the project started with various communication technologies. In future, projects should not repeat this task (or better say should not repeat this task with the same depth) but concentrate on one technology (which should be WLAN technology, see our recommendation for future developments below). Concentrating on one technology and focusing all partners on one technology would possibly lead to a complete and final standard of the communication technology, protocols, and interfaces in a single project. Such a technology should be open for car-to-car and car-to-infrastructure communication and should have special focus on security aspects like privacy and trustworthy.

The application area needs more focus because it is still in a very prototypical stage. We showed in the CarTALK project that we can indeed realize pretty impressing and interoperable applications and all partners are quite proud of their success. Nevertheless, application design must come to a more complete development and assessment of all involved fields like human machine interface design (which satisfies all legal aspects) and integration into existing telematics technology. It might turn out that focusing on less applications but completely defining and starting standardization of them is the right way of going ahead. Note, with standardisation of course not the companies individual HMI and look-and-feel is meant, but the interoperability and maybe the basic algorithms for example for traffic jam detection, lane merging detection and so forth.

3.2 Future developments

Positioning Technologies

GALILEI

On 23 September 2002 the Galileo web-site published a technical document "High Level Mission Definition version 3.0" describing the Galileo system from a technical perspective. On 09 October 2003 the Galileo web-site published a new technical document "The Galilei Project - GALILEO Design consolidation" including detailed information on the positioning accuracy. From these documents the following can be concluded in relation to the CarTALK project and future project in this area.

Accuracy:

The Galileo Open Service provides positioning, velocity and timing information that can be accessed free of direct charge. This service is suitable for mass-market applications, such as in-car navigation and hybridization with mobile telephones. Location accuracy:

- Single Frequency: H: 15 m, V: 35 m
- Dual-Frequency: H: 4 m, V: 8m

The Commercial Service will allow the development of professional applications, with increased navigation performances and added value data, compared with the Open Service. The Commercial Service will be a controlled access service operated by Commercial Service Providers acting after a license agreement between them and the GOC. Location accuracy:

- Global: < 1 m (dual frequency)

Conclusions:

The accuracy of the Galileo Open Service does not meet car-to-car application requirements. The accuracy of the Galileo Commercial Service does meet some of the CarTALK requirements, however additional user fees will be applicable (it is not a free service!).

Combined Services:

Whilst other GNSS systems make ideal candidates for combination with Galileo, some inherent weaknesses, such as weak signal strength and limited communication capability can only be solved through combination with other existing non-GNSS navigation (Loran-C) and communication systems (UMTS) or even

with on-board sensors (INS). For positioning these systems can be grouped into the following categories:

1. Other non satellite-based radio navigation systems (e.g. LORAN-C): Such systems may offer improved signal strength, which provides better indoor penetration and resistance to jamming. Such systems may also offer a limited communication capability (EUROFIX)
2. Mobile communication networks (e.g. GSM, UMTS): These systems can be considered as communication systems offering a complementary positioning capability (e.g. E-OTD) to the user in satellite critical environments. The complementary positioning, calculated either by the network and relayed to the user under request or by the user equipment, can be hybridized with the Galileo position solution in the user equipment. In addition, a different solution combining communication-ranging sources (e.g. Observed Time Difference measurements derived from GSM Base Stations) with Galileo ranges in a hybridized receiver will also allow positioning enhancement performances (accuracy, availability) in critical environments.
3. Motion Sensors (e.g. odometers, INS): When combined in hybridized receivers, short-term outages of the Galileo signal can be overcome by forward interpolation. This combination provides an enhancement of Galileo service robustness and availability, especially in urban environments, where such short-term outages are commonplace.

Conclusions:

Options 1 and 3 seem suitable approaches for usage in future car-to-car applications. Due to the lack of availability of LORAN-C signals on the test sites, option 3 is preferred, especially since the text mentions that short-term outages of Galileo signals in urban environments will be commonplace.

EGNOS

EGNOS will provide a multimodal and civil service to different European user categories, namely: general public/mass market users, specialist users and safety critical users. From this perspective, EGNOS will be an early tool for the development of future Galileo applications, as the EGNOS service will be available from 2004. EGNOS will provide 3 types of services:

- Ranging service: The EGNOS geostationary satellites will provide additional GPS-like ranging sources.
- Wide area differential corrections: EGNOS will improve the accuracy of GPS and GLONASS providing differential corrections.
- Integrity: EGNOS implements a warning of system malfunction (integrity) of GPS and GLONASS constellations.

The EGNOS service will be a civil service offered openly. Although the EGNOS service is conditioned to GPS availability, it is foreseen that a contractual relationship will be established

between the Service Provider and some users by which service guarantees may be given.

Conclusions:

This is a very suitable approach for usage within car-to-car applications.

GLORIA

General Approach:

GLORIA is a 5th Framework Program in the area of Information Society technologies (IST) aiming at the development of an integrated GNSS/ LORAN-C system for applications in road and rail transport. The combination of Global Navigation Satellite Systems and the existing terrestrial LORAN-C position determination system will improve the reliability and availability of the position determination; however this will not by itself result in an improved positioning accuracy. GLORIA will develop and optimize receivers combining GNSS with LORAN-C and using the complementary attributes of both approaches. The range of applicability and system performance of the combined system under typical situations of road and rail applications will be tested. Furthermore, it will identify market opportunities, assess the potential and develop implementation strategies for the most promising applications, with special emphasis on safety critical applications. Finally, GLORIA will investigate possible improvements of the GALILEO system implementation mainly considering best benefits resulting from combinations with terrestrial position determination.

Technical Approach:

The use of GPS in road and rail transport is still limited by the fact that the position signal is not available in many places. GALILEO, the European satellite navigation system, will bring some improvements, however it will not solve the issue of coverage in difficult terrain. One of the possibilities to address this issue is the combination of different positioning systems.

Two of these positioning systems are LORAN C and GPS. LORAN C is substantially older than a GPS and was developed in the USA primarily for naval applications. The LORAN C system uses the same principle as used in GPS: the position of a receiver is determined by the running times of signals from several transmitters. There are however two essential differences between both systems: LORAN C uses a transmitter on the surface of the earth while GPS uses satellites in an orbit around the earth, and LORAN C uses long wave communication while GPS uses signals in the micro wave band.

The advantage of these long wave communication signals is that they provide a very wide coverage, even in areas where GPS coverage is poor. However the long wave communication signals also have the unfavorable characteristic that, depending on the local characteristics of the earth surface, these signals tend to spread at different speeds. When used on land (in contrast to when used on sea) these then leads to systematic position deviations of several hundred of meters, which for most applications are intolerable. Luckily these deviations change locally and temporally only very slowly, so it is possible to calibrate a LORAN-C-position with a more accurate positioning system like GPS. If however the GPS coverage fails, the corrected LORAN C position can be extended and used to navigate also over longer stretches with sufficient accuracy.

GLORIA will therefore combine the position signals of GPS with LORAN C and in the future maybe also with other GNSS's like the GALILEO system.

Technical Results:

Under a favorable constellation of the LORAN C transmitters, it was possible to attain a relative position accuracy in the order of magnitude of 5 meters (even when GPS coverage was lost). The expected high availability of the LORAN-C-signal appeared to be realistically. Further examinations are necessary to determine the possible influences which could lead to a deterioration of positioning accuracy. In addition prototypes have been produced of hybrid GPS / LORAN C receivers.

It is important to note that the current LORAN C transmitters as set up along the coast are not optimal for navigation in the inner European countries (e.g. especially in Switzerland). For these countries an extension of the LORAN-C-network would be an essential part for the improvement of the position determination, especially under the difficult conditions as found in some of these inner European countries (mountains etc).

Possible Applications:

The GLORIA technology appears very promising for the following applications: Floating car data, automatic park fee collection, vehicle navigation, public transportation in rural areas (call bus etc.), dynamic priority for public transportation, tracking of transportation of dangerous goods, adaptive maximum speed limits, automatic freeway fee collection.

Comments:

The GLORIA technology itself does not provide a more accurate GPS signal, it mainly provides a localization system, which is less susceptible for the coverage problems as found with GPS in certain areas.

In Europe NELS (Northwest European LORAN C system) takes care of the LORAN C system. They are at this moment extending LORAN C with Eurofix, a differential correction signal for GPS (DGPS). Since the long waves used in LORAN C provides an almost full coverage of West Europe, the Eurofix system offers an attractive alternative to EGNOS, the correctional GPS signal provided by a set of geostationary satellites. The European LOREG project (LORAN / Eurofix / EGNOS Test & validation program) will address issues in the area of DGNSS for LORAN, Eurofix and EGNOS.

Communication Technology

In the CarTALK project we considered several promising communication technologies and made significant progress in tailoring them for our anticipated scenarios and applications. Other national projects like Fleetnet (www.fleetnet.de) and US projects have done maybe less extensive but in principle similar comparisons.

In the end, when comparing all considered technologies, we see strong technical advantages of UTRA-TDD technology or very low system and integration complexity which simplifies introduction of SRD technology. Therefore, both systems could be used for car-to-car communication. In particular, SRD could be used as an introduction technology and UTRA-TDD would be a good candidate for a later system with very robust and predictable behaviour for safety applications.

Nevertheless, the most likely communication technology for further investigation and finally for system introduction is the WLAN technology. The main reasons for this selection is that WLAN technology is already available, that it is a worldwide standard, that it is already pretty cheap, that the standards can be improved for our requirements and finally because WLAN opens the market for a broad range of applications, starting from entertainment, electronic toll collection, hot spot communication, Voice over WLAN, vehicle-to-vehicle and vehicle-to-infrastructure communication. This means, the costs for introducing this technology can be shared among the applications which seems to be the best strategy to overcome the first mover disadvantage and pledges for fast and high market penetration.

Note, it is not meant that the usual consumer technology like 802.11b will be used for car-to-car communication. This would be possible, though, but it would suffer from drawbacks like limited communication range, limited quality of service and shared bandwidth with other, non-vehicular applications. Instead a new standard based on 802.11 will be proposed for car-to-car communication, which is expected to be included in multi-protocol/multi-mode WLAN chips for vehicular use (not in chips for mass market use). This standard will solve some of the remaining problems like sending power (sending range), quality of service, reliability and others. Because this standard could be included in multi-protocol/multi-mode chips, a single integrated vehicular WLAN chip could serve for a multitude of applications ranging from entertainment to safety applications.

In 2004 the IEEE 802.11p Task Group was established for Wireless Access in Vehicular Environments (WAVE) which exactly addresses that issues. The goal is an amendment of IEEE 802.11 standard to support communication between vehicles and the roadside and between vehicles while operating at speeds up to a minimum of 200 km/h for communication ranges up to 1000 meters, in the 5 GHz bands. The Dedicated Short Range Communications (DSRC) is a general purpose communications link between the vehicle and the roadside (or between vehicles) using the 802.11p protocol. The new 802.11p protocol improves on the range and speed of transmission on the dedicated 5.9 GHz licensed band. Especially the US government is pushing forward to introduce that technology on their highways (with vehicle-to-infrastructure communication). In general, all car manufacturers believe that we should aim at a global and harmonized standard for it and 802.11p would be an ideal basis, but for Europe it means that we must focus strongly on taking part in the 802.11p standardisation process. Future projects should strongly consider 802.11p as the most appropriate candidate for the target communication technology and should be involved in the standardisation process.

In Europe, the Car2Car Communication Consortium (C2C-CC, a non-profit organisation initiated by European vehicle manufacturers) is trying to establish an open European industry standard for Car2Car communication systems to guarantee European-wide inter-vehicle operability and to promote the allocation of an European wide exclusive frequency band for Car2Car applications, starting from the technological results achieved by CarTALK 2000 and WAVE projects. We expect the C2C-CC to be the ideal basis for further development of the communication technology but also the applications and all future projects should try to cooperate with C2C-CC in order to avoid double work.

Furthermore, it is interesting to note that the ISO CALM project (Continuous Air interface for Long and Medium distance) wants to provide a Standardized set of air interface protocols and parameters for medium and long range, high speed ITS communication using one or more of several media, with multipoint and networking protocols within each media, and application layer protocols to enable transfer between media. This service includes Vehicle-Vehicle, Vehicle-Infrastructure and Infrastructure-Infrastructure communications.

Applications

In the automotive field, current and future technological scenarios will drive the interest of the market for telematic products and services. Within this context, the capability of sharing information efficiently becomes essential, both for safety and infotainment applications.

As a matter of fact, the integration of short and medium range communication technologies in our vehicles will bring them to be considered more and more as *remote* and *mobile* clusters of a more complex communication network.

The vehicle as an extension of My Home concept

The first and simplest example of this is the use of consumer electronics in co-operation with the on-board telematic systems. The general trend is to enhance personalization and mobility capabilities of all kinds of consumer devices. This will bring to a strong evolution in the usage models of home and automotive electronic devices; audio/video devices, mobile phones, etc. cannot be considered simply as optionals of our houses or cars: they have to be flexible and fit to all kinds of usage context.

Nowadays, the most common example of such a trend is the use of Bluetooth technology to connect phones and other driver's personal devices to the on-board telematic systems. Tomorrow, the availability of WLAN interfaces in our vehicles will allow them to interact with our wireless home network, being an active part of it, to share – for instance – multimedia contents or other services.

This concept of connectivity can be easily extended from an *in-house* to an *urban* scenario, considering the WLAN enabled car as a possible client for the wireless *hot spots*, offering Internet connectivity and similar services, that will be deployed in the towns of future.

Vehicle-Vehicle and Vehicle-Infrastructure communications for safety applications

Speaking of safety applications, the CarTALK 2000 project successfully demonstrated the potential of using inter-vehicle communications to implement innovative ADAS functions, both for safety and comfort purposes. The future efforts in this field will have to be focussed on building more robust and efficient applications, integrating also communications with the road infrastructure.

The same concept that inspired the CarTALK 2000 project (driver assistance systems based upon vehicle sensors can offer an effective real time *vehicle surrounding situation awareness*, but cannot go beyond the operative range of sensors) will drive to enhance the use of vehicle-to-infrastructure communications for safety purposes. The step beyond is the extended coverage that can be offered by the cooperation of vehicles and infrastructure and by a network of cooperating vehicles to guarantee a complete coverage of all different potential dangerous situations.

Typical situations that could be managed by a *dynamic vehicle network* and by a *vehicle to infrastructure network* extending the operative range of on board vehicle systems are:

- adverse weather conditions (e.g. reduced visibility);
- dangerous road conditions (e.g. ice);
- obstacles that cannot be seen by on board sensors (e.g. blind curves);
- complex road conformity (e.g. intersections, tunnels);

- vulnerable road users (e.g. pedestrians).

4 Conclusions

The 5th framework project CarTALK 2000 brought together the extensive knowledge of the leading European manufacturers of vehicles, vehicle components and communication systems, plus renowned research institutes. The seven partners DaimlerChrysler, CRF, BOSCH, Siemens, TNO, University of Stuttgart and University of Cologne focussed its research activities on safety related communication based driver assistance systems.

All major work tasks converged in a prototype demonstrator. In the final demonstration in July in Balocco, the CarTalk consortium has demonstrated its result with six probe vehicles and a comprehensive simulation environment for the three application clusters:

- Information & Warning Functions (IWF), which disseminate information about traffic jams, dangerous road surface conditions, intersection warning, etc.
- Communication-Based Longitudinal Control (CBLC), which adapt longitudinal control, i.e. acceleration and deceleration to the whole convoy in front, resulting in increased safety more natural following behaviour and traffic flow
- Co-operative Driver Assistance (CODA), which allow automatic or assisted complex manoeuvres like lane merging and highway entering.

The demonstration is only the end result of comprehensive research, design and engineering work. In the planned period from August 2001 to July 2004 the CarTalk project achieved major progress and their anticipated goals in the following areas:

- Specification of today's and future applications for co-operative driver assistance systems and selection of those which can be realized in the framework of this project.
- Development of software structures and algorithms, e.g. new fusion techniques for radio-based sensor information and local sensor information
- Development of a self-organising radio system for inter-vehicle and vehicle-infrastructure communication
- Algorithms for radio ad-hoc networks with extremely high dynamic network topologies
- Integration of the communication system hardware and algorithms into test vehicles
- Integration of the applications into probe vehicles to test and demonstrate both, info-mobility applications (existing applications) and safety applications in the same system architecture

- Test and demonstration of assistance functions in probe vehicles in real traffic scenarios

The results have been achieved in 15 deliverables and some accompanying technical reports. The project consortium has published its results in more than 20 scientific papers and has delivered talks on more than 30 occasion. Three patent applications about the communication system are pending.

Apart from technological goals, CarTALK 2000 actively addressed market introduction strategies in particular addressing the penetration problem, including cost/benefit analyses, and legal aspects.

The socio-economic assessment has been carried out for the basic warning function from the IWF class and for the early braking function from the CBLC class. In short both systems, basic warning and early braking will lead to significant benefits by reducing accidents and hence are desirable from a societal point of view.

For standardization, the Car-to-Car Communication Consortium (C2C-CC) was founded including besides the CarTALK vehicle manufacturers other major European vehicle manufacturers and suppliers. These companies have a strong interest in standardisation of the communication hardware, protocols and safety applications. Without CarTALK and accompanying national research projects this would have been unlikely to happen, not only because of the missing necessary knock-on financing but because only in these programs it was possible to bring all necessary knowledge which cannot be found in a single company together.

With the CarTALK work continued in C2C-CC we expect that we will achieve a European car-to-car standard which paves the way for a broad market introduction. We expect that first applications will be IWF and possibly assistance functions without active vehicle control.

References

CarTALK Website, www.cartalk2000.net

Response 2 Project Report: "Legal and Liability Issues regarding Inter-Vehicle-Communication Car Talk 2000, Christine Kanz, 2004"

Abbreviations

ADAS	Advanced Driver Assistance Systems
C2C-CC	Car-to-Car Communication Consortium
CBLC	Communication Based Longitudinal Control
CODA	Co-operative Driver Assistance
DSRC	Dedicated Short Range Communication
EQR	Equipment Rate
GPS	Global Positioning System
ISM	Industrial, Scientific, and Medical band
IWF	Information and Warning Function
WAVE	Wireless Access in Vehicular Environments
WLAN	Wireless Local Area Network

Annex 1: Deliverable and other outputs

A comprehensive table of the articles and conference presentations is included in the following tables.

Deliverables

The following deliverables were produced in the CarTALK lifetime.

Deliverable code & name	Planned delivery date	Actual delivery date	Responsible partner
D1 – Application specification	M05	M06	DCAG
D2 – Hazard analysis	M06	M07	DCAG
D3 – CarTALK 2000 website	M06	M07	DCAG
D3 – CarTALK 2000 flyer and brochure	M09	M11	DCAG
D4 – Communication platform	M10	M12	TNO
D5 – Demonstrator prototype specification	M12	M15	CRF
D6 – Communication architecture	M15	M15	SMC
D7 – Protocol prototype implementation	M27	M27	USTUTT
D8 – Protocol safety analysis	M27	M27	DCAG
D9 – Protocol standardisation	M30	M32	SMC
D10 – Demonstrator vehicles ready	M30	M35	DCAG, CRF, TNO
D11 – CarTALK 2000 video	M30	M36 (draft)	DCAG
D12 – Socio-economic assessment	M35	M36 (draft)	UoC
D13 - Demonstration day	M35	M36	DCAG
D14 – Technology implementation plan	M36	M36 (draft)	DCAG
D15 – Final report	M36	M36 (draft)	DCAG

Dissemination

The following dissemination activities were performed within CarTALK.

No.	Date	Title	Number of persons attended & other information
1	2001	DC report	DaimlerChrysler Hightech Report
2	2001/2002	University of Stuttgart report	Institut für Parallele und Verteilte Höchstleistungsrechner, Universität Stuttgart (article in German)
3	22.02.2002	FleetNet Special Interest Workshop on Inter-Vehicle Communication	The intention of the workshop is to prepare standardisation of the communication system. A presentation of CarTALK 2000 was given by Dr. Reichardt on behalf of the project consortium. The workshop was attended by members of DCA, CRF, TNO, BOS, and SICN.
4	April 2002	TNO Report	TNO Automotive, By the Way
5	May 2002	Journal article	Spektrum der Wissenschaft (article in German)

No.	Date	Title	Number of persons attended & other information
6	18.-20.06.2002	IEEE Intelligent Vehicle Symposium, Versailles	Presentation and conference paper "CarTALK 2000 - Safe and Comfortable Driving Based Upon Inter-Vehicle-Communication", in session no. 6 on Future Transportation Systems.
7	August 2002	TNO report	TNO Traffic and Transport, Transport Matters
8	September 2002	Journal article	Funkschau (article in German)
9	16.-18.09.2002	IT Solutions for Safety and Security in Intelligent Transport, Lyon	Presentation and conference paper "Design of an application for communication-based longitudinal control in the CarTALK project" in technical session 29 – ADAS - systems technologies and functionality.
10	29.-30.10.2002	2 nd ADASE II concertation meeting, Brussels	Presentation of CarTalk2000 work on driver assistance applications
11	05.-06.02.2003	ADASE II Expert Workshop on Vehicle – Vehicle and Vehicle - Infrastructure Communication, Paris	Presentation of CarTalk2000 project and communication technology developed.
12	15.-18.06.2003	IST Mobile and Wireless Communications Summit, Aveiro	Presentations and conference papers "Architectural and technical aspects for Ad Hoc Networks based on UTRA TDD for Inter-Vehicle Communication" and "Routing approach in CarTALK 2000 project" in session "Ad Hoc Networks"
13	25.-27.6.2003	Med-Hoc net 2003, Mahdia, Tunisia	Presentation and conference paper "Inter-Vehicle Communications: A New Frontier of Ad-Hoc Networking"
14	2.-4.7.2003	Workshop on Applications and Services in Wireless Networks (ASWN), Bern, 2003	Presentation and workshop paper „Virtual Traffic Signs: A Geocast Enabled Service for Ad Hoc Networks“
15	6.-9.10.2003	IEEE Vehicular Technology Conference (VTC), Orlando, USA	Presentation and conference papers "Performance Analysis of Stored Geocast" in session "wireless ad hoc and sensor networks" "MAC for ad-hoc inter-vehicle network: services and performance" in session "wireless ad hoc and sensor networks"
16	12.-15.10.2003	IEEE International Conference on Intelligent Transportation Systems (ITSC), Shanghai, China	Presentation and conference paper about "Spatially Aware Packet Routing for Mobile Ad Hoc Inter-Vehicle Radio Networks"
17	13.-14.11.2003	International Task Force on Vehicle-Highway Automation (ITFVHA)	CarTalk2000 presentation of current status and achievements.
18	17.-20.11.2003	ITS World Congress Madrid	"CarTALK2000: Development of a Co-operative ADAS based on vehicle-to-vehicle communication" T 2575 in the session

No.	Date	Title	Number of persons attended & other information
			PS108 ADAS – various “Traffic simulation and socio-economic assessment of inter-vehicle communication systems in CarTALK” T 2462 in the session PS045 Public-Private Partnerships - costs & benefits CarTalk2000 booth with poster, PowerPoint presentation and application video.
19	2003	DC High-tech report	DaimlerChrysler Hightech Report on vehicle-to-vehicle communication
20	19.-20.1.2004	3 rd ADASE II concertation meeting, Brussels	Presentation of CarTalk2000 work and current state. Discussion with other projects and sharing of ideas and results.
21	4.-6.2.2004	Conference on Wired/Wireless Internet Communication (WWIC), Germany	Paper preparation and presentation “CGGC: Cached Greedy Geocast”
22	23.-24.3.2004	International Workshop on Intelligent Transportation (WIT), Hamburg, Germany	Two papers with CarTalk participation have been prepared and presented regarding a platform for inter-vehicle communication and routing table management for mobile networks.
23	3.-4.3.2004	DC workshop together with BMBF project Fleetnet and VSC from USA	Discussion about radio frequency planning and co-operation of national, European and USA activities.
24	26.-27.2.2004	WLDW / WILLWARN kick-off	Attending the WLDW kick-off had the intention to share the ideas and the results of CarTALK 2000 with them to avoid double work and pitfalls. Discussion about next steps and necessary further activities. Exchange of deliverables.
25	29.-30.4.2004	RESPONSE II Workshop	Intention was to share the results of RESPONSE II with the ADAS interested audience. The cooperation with RESPONSE II resulted in a deliverable of the legal situation of CarTALK applications. A presentation was given from a CarTalk partner about the introduction of an emergency braking system.
26	27.-30.6.2004	IST Mobile and Wireless Communications Summit, Lyon	A paper was prepared and is presented about “The optimum mapping of AD HOC MAC on slotted channel for Ad Hoc Networks”
27	23.-27.8.2004	ECAI'2004 conference, Valencia	Paper accepted describing the CarTALK CODA part.
28	10.-13.10.2004	IEEE International Conference on Systems, Man and Cybernetics, The Hague, NL,	Paper accepted for presentation: “Design and Test of a communication based Advanced driver assistance System”
29	2004	Elsevier Computer	Journal article “Time-stable Geocast for Ad

No.	Date	Title	Number of persons attended & other information
		Communications	Hoc Networks and its Application with Virtual Warning Signs
30	2004	IEEE Communications Surveys and Tutorials, IEEE, 2nd quarter issue, Vol. 6, No. 2, 2004	Journal article „A Survey on Geocast Routing Protocols”,

Annex 2: Project management and co-ordination

The project management was performed by DaimlerChrysler as a service to the consortium. Each partner shared the cost for this overall management. The actions of the management were transparent to the partners and controlled by the same mechanisms as for the work packages.

Given the compact size of project and consortium a light management structure was chosen, that allowed good control as well as transparent delegation and clear reporting lines

The project management committee (PMC) performed the operational management of the project. The PMC consisted of the project manager and the work package managers of the partners. Decisions concerning the normal running of the project were taken by the project management committee. They were always reached unanimously. A so-called the project control board (PCB), consisting of senior managers of the partners, to make final decisions had never to be called in.

The project manager from DaimlerChrysler performed the day-to-day management of the project. This included contractual commitments, and budget as well as technical control. Sub-responsibilities were delegated to:

- Project support, to provide supportive services for the project work,
- Project controlling to exercise financial and budget control, and
- Work package management, responsible for the co-ordination and planning of the tasks in the specific work packages.

In order to achieve the project goals, a comfortable and efficient communication between all project partners and the project management had to be assured. Therefore, an appropriate communication strategy was established to ensure a proper both internal and external information sharing and to keep all partners fully informed about the project status. All project documentation (internal and external) was standardised in terms of common rules for files/report exchange, SW tools, format, etc..

The project progress was controlled by executing a navigation cycle "planning, execution, analysis, revision" every three months. The navigation cycle was executed on occasion of the three monthly meetings of the CarTALK 2000 project management committee (PMC).

The project planning was performed by the project manager together with the work package managers (technical contents, milestones) and the project controller (budgets and resources). Work progress was reported on task level on a three monthly basis on occasion of the PMC meetings.

The deliverables were produced within the individual work packages. As a quality assurance measure all deliverables were subjected to an internal 'Peer Review' before submitting them to the EC and external experts.