



Project no.

IST – FP6 – 2002 – Aero 1 - 502793 – STREP

Project acronym:

ADLAND

Project title:

Adaptive Landing Gears for Improved Impact Absorption

Instrument:

Specific Targeted Research Project

Thematic Priority:

4. Aeronautics and Space Priority

Title of report:

Final publishable activity report

Summary of the complete project activities and achievements

Document author/s:	Grzegorz Mikułowski				
Document owner:	IFTR				
Period covered: from	12.2003	to	12.2006	Date of preparation:	01.2007
Start date of project:	01.12.2003		Duration:	3 years	
Project coordinator name:	Jan Holnicki-Szulc				
Project coordinator organisation name:	Institute of Fundamental Technological Research				
Revision	3				

Table of contents

1	Summary description of project objectives.....	3
2	Participants' data	4
2.1	IFTR (Warsaw, Poland)	4
2.2	EADS (Munich, Germany).....	5
2.3	PZL Mielec (Mielec, Poland)	6
2.4	IA (Warsaw, Poland).....	6
2.5	FhG-ISC (Wuerzburg, Germany)	8
2.6	CEDRAT TECHNOLOGIES (Grenoble, France).....	9
2.7	USFD (Sheffield, United Kingdom)	11
2.8	MD (Velizy, France)	12
3	Motivations for the project.....	14
4	Summary of the whole project activities and achievements	16
4.1	Introduction	16
4.2	The project's development	17
4.2.1	Feasibility study, potential for improvement.....	17
4.2.2	Development of the MRF actuated adaptive landing gear	18
4.2.3	Development of the Piezo actuated adaptive landing gear	19
4.2.4	Development of the control system.....	20
4.2.5	Laboratory testing	21
4.2.6	Field testing.....	22
4.3	Main achievements of the project and conclusions	22
5	Impact on the industry branch, impact on the research sector	23
5.1	FhG-ISC	23
5.2	CEDRAT TECHNOLOGIES	23
5.3	USFD.....	24
5.4	MD	24
6	Descriptions of each partner's activities and achievements	26
6.1	IFTR: Institute of Fundamental Technological Research	26
6.2	EADS: European Aeronautic Defense and Space Company	30
6.3	PZL Mielec: Polish Aviation Factory Mielec.....	31
6.4	IA: Institute of Aviation	34
6.5	FhG – ISC: Fraunhofer-Institut fuer Silicatforschung	39
6.6	CEDRAT Technologies	42
6.7	USFD: University of Sheffield	45
6.8	MD: Messier-Dowty	54

1 Summary description of project objectives

The project dealt with evaluating the options for adaptive shock absorbers to be applied in aircraft landing gears. Analytical design procedures were developed to simulate different potential design options and the best practical solution was determined. The different hardware components regarding adaptive shock absorbers were developed and tested with regard to an adaptive landing gear model. The objectives of project were:

- to develop a concept of adaptive shock-absorbers
- to develop new numerical tools for design of adaptive vehicles and for simulation of the adaptive structural response to an impact scenario
- to develop technology for actively controlled shock-absorbers applicable in landing gears (two options: MR fluid-based and piezo-valve-based will be take into consideration)
- to design, model and perform repetitive impact tests of the adaptive landing gear model with high impact energy dissipation effect.
- to design, produce and test in flight the chosen full-scale model of the adaptive landing gear.

In contrast to the passive systems the conducted research focused on *active adaptation* of energy absorbing structural elements where a system of sensors recognises the type of impact loading and activates energy absorbing components in a fashion that guaranteed optimal dissipation of impact energy.

The proposed approach focused on *active adaptation* of the energy absorbing system (equipped with sensors identifying impact in advance and controllable semi-active dissipaters) with the ability to adapt to extreme overloading during landing. The term *active adaptation* refers to the particular case of actively controlled energy dissipater, where the need for external sources of energy is minimized and the task for actuators is reduced to modify local mechanical properties rather than to apply externally generated forces. These applications of active control concept are usually more reliable, stable and cost-effective. Therefore, adaptive systems are more appropriate in the impact dissipation task than their fully active counterparts.

2 Participants' data

List of Participants:

	Abbreviated name	Full name	Status in the project	Country
1	IFTR	Institute of Fundamental Technological Research, Warsaw	Research institute Co-ordinator	Poland
2	EADS	EADS Deutschland GmbH, Military Aircraft, Munich	Industrial end-user	Germany
3	PZL	Polskie Zaklady Lotnicze, Mielec	Industrial end-user	Poland
4	IA	Institute of Aviation, Warsaw	Research institute	Poland
5	FhG-ISC	Fraunhofer Institute, Wuerzburg	Research institute	Germany
6	CEDRAT	CEDRAT Technologies, Grenoble	SME company	France
7	USFD	University of Sheffield, Sheffield	University	U.K.
8	MD	Messier-Dowty	Industrial end-user	France

Co-ordinator Name: **Jan Holnicki-Szulc**

Co-ordinator organisation: **Institute of Fundamental Technological Research**

Co-ordinator e-mail: **holnicki@ippt.gov.pl**

Co-ordinator tel/fax: **+48 22 828 7493**

2.1 IFTR (Warsaw, Poland)

Institute of Fundamental Technological Research (IFTR) is one the largest Polish (more than 300 employees) state research institutes covering a wide range of basic and applied technological research areas, such as engineering structural analysis, solid state mechanics, fluid mechanics, coupled field theory, acoustics and mechatronics. Established 50 years ago, it develops both theoretical as well as experimental basic research. In particular, the fields of optimal structural design and structural dynamics, computational mechanics and active

structural control, relevant to the participation of IFTR in this project are strongly represented by skilled staff of the **Smart Technology Centre** with many years of experience. Particularly, the following research topics are recently under development in the Smart-Tech Centre.

Adaptive microstructures

Modelling of microstructures with controlled local characteristics (e.g. yield stresses triggering plastic-like adaptation) allows developing new class of high-performance impact energy absorbing materials. The impact capacity of such adaptive materials will be much higher than classical honeycomb-type passive microstructure

Structural health monitoring (damage identification), mathematical concept and numerical tools for (VDM based) modelling of inverse, non-linear dynamic problem.

Vibration control, Development of the concept of fully dissipative vibration control based on phenomena of *prestress-accumulation-release*. Application to so called “smart skin” problem.

Impact control Semi-active control of adaptation to impact. Especially, software vs. experiment verification to evaluate the control strategies. Numerical simulation and design of adaptive structures. Non-linear dynamics for active and semi-active structural control. Inverse non-linear dynamic problem, Adaptive crashworthiness.

2.2 EADS (Munich, Germany)

EADS European Aeronautic Defence and Space Company is the largest aerospace company in Europe and the second largest worldwide. The company is active in civil and military aerospace, space, defence systems and services. Daimler Chrysler Aerospace AG, French Aerospatiale Matra and CASA of Spain merged into EADS on 10 July 2000. In 2001, EADS reported revenues of € 30.8 billion with a share 80 percent civil and 20 percent military market. The company employs over 100,000 people at more than 70 production sites, above all in Germany, France, Great Britain and Spain.

Military Aircraft is one out of six business units in the aeronautics division of EADS. In 2001 Military Aircraft reported a turnover of €1.5 billion. It employs approx. 7400 people in four locations. The headquarters are located in Ottobrunn in the South of Munich with the development centre. The Spanish management is based in Getafe near Madrid with Eurofighter production and flight test testing in Spain, maintenance, overhaul and modification of fighter, trainer and transport aircraft for the Spanish armed forces as well as other customers. The Augsburg based facility is responsible for the production of complete

aircraft components, namely the centre fuselage sections for all Eurofighters, and the rear fuselage sections of almost every Airbus type. Manching is the home of Eurofighter final assembly in Germany, and the military support programmes for Bundeswehr and NATO aircraft.

Military Aircraft has system design responsibility for Landing Gear Systems on Tornado, Eurofighter and C160 therefore the involved department has distinctive experience in conventional Landing Gear applications of different sizes. It is also involved in the development of other new technologies as e.g. electric brakes. The Landing Gear Department has a long history of cooperation with universities in educating students to the current state-of-the-art technology.

2.3 PZL Mielec (Mielec, Poland)

Polskie Zakłady Lotnicze (Polish Aviation Factory) a Limited-Liability Company, is presently the largest aircraft manufacturer in Poland. For over 60 years aviation industry has been active in Mielec, the town in South-Eastern Poland, and the Factory continues as producer of world wide-popular agricultural & fire-fighting planes, passenger/cargo commuters and trainer aircrafts.

The Company's main strategic objective is to develop products of its own design and their introduction onto various markets of the world. One of the corporate priorities is also to increase the share of international aviation-related co-operation programs with the world's leaders in the aviation industry.

BAE Systems, BOEING, CESSNA, SAAB, GKN Westland , Pratt & Whitney, Lockheed Martin are some of the brand-names the company supplies to on a sub-contracting basis.

2.4 IA (Warsaw, Poland)

INSTYTUT LOTNICTWA (Institute of Aviation - IA) established in 1926 is the main design, research and development center for Polish Aviation Industry, performing many design and research projects and scientific works, strictly focused on international cooperation, integrating with 5/6 Framework Program and worldwide R&D domain. Sector of activity is

aircraft and helicopters aerodynamics and structure, combustion, strength and dynamics, composite materials, wind tunnels, turbojet and piston engines, landing gear testing, aircrafts, helicopters and hovercrafts design, avionics and system integrations, biofuels and environmental tests, co-operation with non aviation industry to transfer elements of high developed technology to that industry. Last main products of IA are combat trainer jet I22 “IRYDA” (MTOM 8900 kg), composite personal & business aircraft I-23 “Manager” with MTOM 1150 kg (FAR Part 23, Amdt.1-42), High – G Human Centrifuge with “Push –pull” system, composite rescue-patrol hovercraft PRP 560 “RANGER”, helicopter IS-2, landing gear for M28 “Bryza” a versatile, transport category airplane with STOL. According an agreement with General Electric Aircraft Engines IA established new form of co-operation in engineering services - Engineering Design Center. IA opened Materials & Structures Research Center with Pratt &Whitney. IA is realizes “offset” with Lockheed Martin and EADS CASA The experience in 5/6 Framework Programme has been connected with several activities. Main last industrial foreign partners General Electric, Pratt& Whitney, Rolls Royce, EADS CASA PZL and partners from Poland like PZL“Mielec”, PZL”Swidnik”, PZL “Rzeszów”, etc.

IA Participation in 5 FP:

1. **“HELIX”** – “Innovative aerodynamic high lifts concepts” - Growth 3, RTD, : 01/06/2001-30/04/2005 (+ annex 2006),
2. **“HiReTT”** – “High Reynolds number tools and techniques for civil transport aircraft design” - Growth 3, RTD, : 01/08/2002-30/11/ 2005
3. **“UAVNET”** – “ Civilian UAV Thematic Network: Technologies, Application” - Growth 3, SSA/CA, : 01/05/2002-30/11/2005
4. **„NAS-TAURUS”** - „Technology development for aeroelastic simulations on unstructured grids” - Growth 3, RTD, : 01/07/2002-31/07/2004,
5. **„X²-Noise”**– “Thematic Network on Aeroacoustics of New Aircraft & Engine Configurations – Impact of Aircraft Noise on Future Designs” – Growth 3, SSA/CA, : 01/11/2002-30/04/2006,
6. **„FLITE”** – „Flite test easy” – EUREKA projekt nr E12419, : 1.01.2002 - 30.04.2003,
7. **“ViewLS”** - Clear Views on Clean Fuels - Diamond VIP - 2003-2005

IA Participation in 6 FP :

1. **“FLITE 2”** – „ Flite test easy - extension” – EUREKA projekt nr 414/E-266/SPB/EUREKA/T-12/DWM 102/2004-2007 : 01/12/2004-30/11/2007 (Eureka)
2. **„AERONET III”** – “Aircraft Emission and Reduction technologies” – Aeronautics CA project nr ACA3-CT-2003-502882, : 01/04/2004-31/03/2008,
3. **„ADLAND”** – “ Adaptive Landing Gears for Improved Impact Absorption” – STREP, project nr AST3-CT-2004-502793, : 01/12/2003-30/11/2006,

4. „**SCRATCH IV** „– “ Support for Collaborative Aeronautical Technical Research” - SSA project nr ASA3-CT-2004-510981, : 01/05/2004-30/04/2006
5. „**HISAC**” – “HIGH SPEED ENVIRONMENTALLY FRIENDLY AIRCRAFT” - Aeronautics IP, projekt nr AIP4-CT-2005-516132, : 01/05/2005-30/04/2008/,
6. „**AirTN**”– “AIR TRANSPORT NET - AERONAUTICS CA, projekt nr 518480, : 01/01/2006-31/12/2008,
7. „**UFAST**”– “ Unsteady effects of shock wave induced separation” - AERONAUTICS STREP, nr: AST4-CT-2005-012226, : 01/12/2005-30-11/2008,
8. „**SOFLA**” - "Safe Automatic Flight Back and Landing of Aircraft" - IP projekt nr AST5-CT-2006-030911, : 01/06/2006-30/08/2009/,
9. „**EPATS**” - "European Personal Air Transportation System" - Aeronautics SSA, nr 044549, : 01. 2007-06. 2008, Coordinator Institute of Aviation
10. „**CESAR**” - “Cost effective small aircraft” - Aeronautics IP, projekt nr 30 888, 1.09.2006-31.08.2009
11. „**SCRATCH**”- "Support for Collaborative Aeronautical Technical Research" - Aeronautics SSA, projekt nr ASA5-2006-036267, : Jun 2006-May 2007,
12. “**SUPERSKYSENCE**” - "Smart Maintenance of hydraulic fluid using on board monitoring and reconditioning system " - Aeronautics IP project nr 030863 : 01/06/2006-30/08/2009,
13. “**DRESS**” – “Distributed and Redundant Electro Mechanical Nose Gear Steering System” - Aeronautics STREP projekt nr. AST5-CT-2006-30841 : 06.2006 - 06.2009.

IA additional data:

Mean turnover / 2006 / about 10 000 000 Euro

Mean Staff: 450/300 /R&D persons.

Type of organization - R&D institute, Governmental type

Owner Ministry of Economy, IA is granted in 27 % by State Committee for Scientific Research, Poland.

www.ilot.edu.pl

2.5 FhG-ISC (Wuerzburg, Germany)

The Fraunhofer-Institut fuer Silicatforschung (FhG-ISC) belongs to the Fraunhofer Society, the largest organisation of applied research in Germany. The institute with nearly 200 employees is active in the development of innovative materials and their associated technologies. Scientists, engineers and technicians cooperate in contract research projects with industrial partners. The institute has a long-term experience from many national and European R&D projects.

A focus of the work in the institute concerns smart materials for actuatoric and sensoric applications. The materials comprise smart fluids (electrorheological and magnetorheological fluids), piezoelectric fibres and films as well as corresponding devices and systems. The

activities in the field of smart fluids started in 1994 and have strongly increased in recent years. The work follows an interdisciplinary approach including chemistry, physics, materials science, engineering and information technology. Present research projects with industrial and scientific partners include the development of magnetorheological fluids for engine mounts, smart soft material based systems for haptic sensor-actuator systems in virtual reality and electrorheological fluids for automotive applications, which has attracted much attention in the media. The main research task is the development of application-adapted smart soft materials based on a profound understanding of the underlying working mechanisms of the materials. Furthermore, various demonstrators for haptic devices, clutches and vibration damping have been built in the institute. Current publications are listed in Refs.11-20.

The competence team of disperse systems which is focussed on smart fluids presently consists of 10 members and several associated co-workers. The team has a long-term experience in the synthesis of such materials, the characterisation of their properties, the investigation of correlations between chemical composition, structure and properties as well as the design of smart fluids with special application-relevant properties. Furthermore, expertise has also been acquired in various applications of smart fluids and in the design of mechatronic systems which are based on them.

For the purpose of materials synthesis and characterisation a sophisticated equipment is available in the institute. Electrorheological and magnetorheological fluids can be produced in quantities of some litres. For the detection of the change of the rheological properties of smart fluids in strong electric as well as magnetic fields special devices have been built. Advanced methods for the characterisation of viscous and viscoelastic properties and the time-resolved behaviour of the fluids and of their sedimentation stability have been developed. A broad variety of analytical equipment for the characterisation of further properties of the materials like size distribution of the particles in the smart fluids, morphology, chemical composition, thermal stability, etc. is also available.

2.6 CEDRAT TECHNOLOGIES (Grenoble, France)

CEDRAT TECHNOLOGIES SA (CEDRAT-T) is a high tech SME of Cedrat group involving 70 peoples based in France close to Grenoble. CEDRAT is specialising in 2 complementary fields of Electric Engineering:

1. Active Material Applications : Applications of piezoelectrics & magnetostrictives
2. Magnetic Device Engineering : Applications of magnetism effects

In both domains, CEDRAT designs and manufactures actuators, transducers, motors, mechanisms, generators, transformers and sensors as well as related electronics.

CEDRAT masters unique technologies of low-voltage piezo-actuators, piezo-transducers and piezo-motors. These are patented and innovative according to the patent search reports. Piezo devices are available both as off-the-shelf products and as customised products. CEDRAT also masters several technologies of low-power electromagnetic rotating and linear drives, including their control/command and their power supply. CEDRAT magnetic devices are mostly developed for customised applications. Considering Industrial Activities, CEDRAT exploits its patents and rights by manufacturing actuators, transducers and motors with electronics, mostly for applications related to micro-positioning, to fast positioning and to vibration generation or damping. These actuators cover linear strokes from 1nm to 100mm and rotating strokes from 10microrad to infinite rotation. Being initially developed for space, they are stiff, robust and efficient. They find presently customers in space, optics, aeronautics, instrumentation, telecom ... Using these actuators, CEDRAT has also developed several multi-degree-of-freedom-mechanisms, for example XYZ stages used for optical lens alignment or for scanning in an AFM microscope for ESA, the European Space Agency. Note that this XYZ mechanism has been successfully space qualified, and that a Flight Model has been delivered. CEDRAT performs also R&D activities and transfers of technologies for mass production application such as automotive industry for instance. For example, a recent patent applied by FIAT reveals the interest of CEDRAT actuators as a low cost efficient solution for injectors. These transfers are completed by training.

For all these projects on electromechanical devices, CEDRAT has ensured the project management, co-ordinating partners for materials, mechanics and electronics.

CEDRAT TECHNOLOGIES began a new Industrial Activity five years ago: CEDRAT TECHNOLOGIES exploits its own patents by developing and manufacturing smart actuators (based on piezoelectric or electromagnetic effects) and related electronics, either as standard products or as OEM applications. Through this project, CEDRAT TECHNOLOGIES will gain significant experience in Smart Actuators for Aeronautics. This market is somewhat similar to the space market with a low number of devices but high reliability. CEDRAT TECHNOLOGIES will also increase its experience in designing magnetic circuits taking into account the aeronautic constraints, and pursuing its smart valve development.

CEDRAT TECHNOLOGIES S.A. has been in charge of several R&D programs related to micro-positioning mechanisms, starting initially for Research & Technology Programs, ending to operational products. For example, for ESA, the European Space Agency,

CEDRAT TECHNOLOGIES has developed a XYZ mechanism for the Midas AFM microscope for Rosetta mission up to the delivery of the Flight Model (to be launched in 2004). For CNES the French Space Agency, CEDRAT TECHNOLOGIES has developed & space qualified a first space MOEMS (micro tiltable mirror inc. sensors). This MOEMS has been selected by EADS in 2002 for applications in PHARAO program.

2.7 USFD (Sheffield, United Kingdom)

The University of Sheffield is a leading UK Higher Education Institution. The Department of Mechanical Engineering is recognised as a centre of excellence for research, and the Dynamics and Manufacturing Research Group has an international reputation. In dynamics, the group has expertise in ER and MR fluids, smart materials and structures, advanced damping technologies, human dynamics, non-linear dynamics, signal processing, and fault diagnosis. Project funding has been sourced from industrial collaborators (including a Rolls-Royce University Technology Centre), the EPSRC, the European Commission, DERA, and the US Army. Within the group's laboratories, a wide range of equipment is available including data acquisition and control systems (Siglab, dSPACE, XPC-Target), modal analysis systems (scanning laser vibrometer, shakers & amplifiers, accelerometers and transducers), along with a large number of PCs with appropriate software (ABAQUS, ANSYS, Matlab & toolboxes).

The department's extensive research on smart fluids has focused on modelling of fluid behaviour, device design and performance prediction, and controller design. This work has been sponsored by organisations such as The Engineering and Physical Sciences research council, the US Army European Research Office, DSO National Laboratories Singapore, and The Ford Motor Company. Models of smart fluid behaviour have been developed over the past 2 decades [1-4], and more recently these models have been extended to include the dynamic behaviour of physical devices [5, 6]. Work on control of smart fluid dampers has focussed on the design of feedback controllers, along with extensive experimental testing [7-11]. Applications that have been investigated include vehicle suspension systems, and vehicle adaptive crashworthiness. Experimental equipment includes servo-hydraulic test machines, a long-stroke sinusoidal excitation facility, and a wide range of data acquisition and control hardware. As a result of this research activity, state-of-the-art modelling and control design techniques are available so that smart dampers can be implemented on practical engineering structures.

2.8 MD (Velizy, France)

Messier-Dowty is the world leader in design, development and manufacture of landing gear systems, with an annual turnover of US\$ 610 million in 2001. Messier-Dowty landing gears are in service on more than 16,000 aircraft making over 30,000 landings every day. The company supplies 30 airframe customers and supports 600 operators of large civil aircraft, regional and business aircraft, military aircraft and helicopters. Messier-Dowty has around 3000 employees in 8 operational sites in France (Vélizy, Bidos), the United Kingdom (Gloucester), Canada (Toronto, Montréal, Peterborough), the United States (Seattle), Singapore and China (Suzhou).

Messier-Dowty bears the name of its prestigious founders - George Messier and George Dowty - who established themselves as leading figures in the aeronautical industry in the 1920s. Messier-Dowty became fully owned by Snecma in June 1998. It is now part of a strong, integrated landing systems structure within the group that produces CFM56 commercial jet engines, power plants for combat aircraft, engines for the Ariane family of launch vehicles, nacelles and carbon brakes, backed by a global network of customer and product support services.

Messier-Dowty has acquired a complete experience in the field of landing gear systems and is the only company in the world able to produce fully integrated landing gear systems. From the entire family of Airbus commercial jets, as well as through growing participation in Boeing's jets, Messier-Dowty has established core equity in the large landing gear business. This expertise also encompasses half of the world's regional and business jet programmes, including Bombardier's Global Express and Continental Business jets as well as the entire family of Dassault Falcon jets like 7X. In the military sector, Messier-Dowty is present on the world's most advanced military programmes, including Boeing's JSF prototype and the F18 E/F, as well as the Eurofighter and Dassault's Mirage and Rafale. Our product range also extends to the field of helicopters and tiltrotors, notably on the Bell BA 609 and the Eurocopter Tiger programmes.

Messier-Dowty global engineering capability is continuously strengthened by the use of the most advanced design software and optimised practices such as concurrent engineering and a "design-to" approach, together with proven experience across all of our sites in Research, Technology, Design, Development and Testing.

Hence a unique combination of advanced engineering capabilities, integrated systems technology, experience on a wide range of programmes and an international organization,

enables Messier-Dowty to anticipate evolutions in the ever-changing aerospace market and provide innovative solutions for aircraft manufacturers in the area of landing gear systems.

3 Motivations for the project

The motivation for this research is to respond to requirements for high impact energy absorption in landing gears. Typically, shock absorbers are designed as *passive* devices with characteristics adjusted either to the most frequently expected impact loads or ultimate load conditions. However, in many cases the variation of real working conditions is so high, that the optimally designed passive shock absorber does not perform well enough. A good example is the variation of impact conditions affecting landing gear in different landing conditions.

Up to now landing gears have been designed as structures with passive oleo-pneumatic shock absorbers or with spring beams as a energy dissipaters. The former has higher efficiency – up to 90% – and is used in most of airplanes. The latter is used in airplanes with take-off masses not higher then 5000 kg (2 268 lb), because of low efficiency and low weight. Landing Gear (LG) must be designed to meet standards such as JAR 23, JAR 25 or other requirements (civil, military, etc.). These requirements were built basing on statistical data of LG parameters such as: sink speed, horizontal speed, loads, number of accidents etc.

The most important parameter describing LG conditions is sink speed, which defines the energy, that must be absorbed by the LG structure. On the other hand, the dissipation energy depends on the LG's shock absorber structure and their behaviour (as the complete landing gear) during the landing process.

The classical LG's characteristic (load versus time) for limit landing parameters is shown on Fig.1, while the idealised behaviour is shown in Fig. 2.

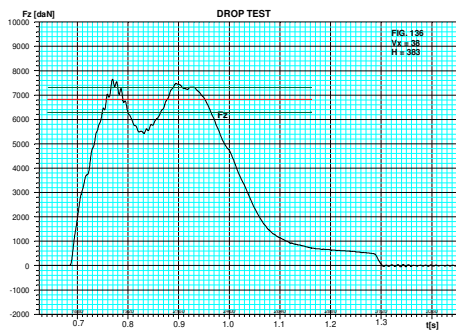

Fig.1 The classical characteristic for limit landing parameters; F_z (daN) - vertical force versus time t (s)

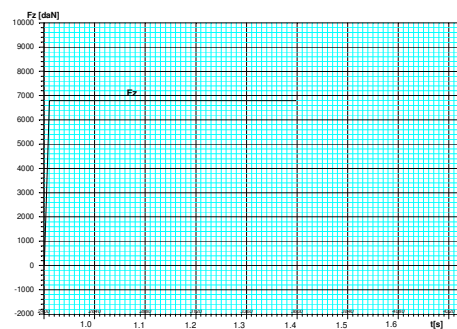

Fig. 2 The ideal (desired) characteristic; F_z (daN) - vertical force versus time t (s)

The load-peaks generated in the landing process are very damaging for the airframe structure. Usually, the LG structure is designed for load factors in the range 0,75-1,5 for a large aircraft, 3,0 for a small utility aircraft and up to 5,0 for a fighter-aircraft.

The airframe designers have to design the airframes to accommodate those factors during various landing scenarios. If the above limits are exceeded, e.g. during a *hard-landing* case, an hazardous situation is provoked where crushing of the airplane structure can cause casualties or fatalities.

On the other hand, the last serious accident in the Polish Tatra Mountains (Feb`2003) of rescue helicopter has demonstrated that well designed landing gear can save human beings.

There is a need for an **adaptive shock absorber** able to reduce the load-peaks by up to 30%

4 Summary of the whole project activities and achievements

4.1 Introduction

The objective of this project was to develop and prove experimentally an adaptive landing gear. The methodology of the actuation for the adaptive landing gear was introduction of an element that change in time the damping force generated by the landing strut.

For the actuation of the system elements two technologies were initially considered: magnetorheological fluids (MRF) and Piezo ceramics actuators. The MR fluid version of the adaptive landing gear utilized the feature of the fluid, which allows changing locally its apparent viscosity by application of external magnetic flux. In the version with the Piezo ceramics, the adaptive landing gear was considered to be equipped in a piezo actuated element that would be able to modify efficiently the flow of the hydraulic oil within the internal circuits.

The main tasks defined for the project participants were:

1. to develop an efficient methodology and strategy of control for the adaptive landing gears during landing impact (with assessment of its applicability and feasibility study)
2. to develop MR fluid in accordance to the requirements defined by the consortium representatives from aeronautic industry.
3. to develop, design and fabricate an adaptive landing gear utilizing the MRF technology. The task in this problem did cover the following issues: design of the device in accordance to the aeronautic requirements, to develop the control unit, which withstand the timing requirements occurring in the case of the landing impact, laboratory validation of the developed and fabricated devices.
4. to develop, design and fabricate a piezo actuated adaptive landing gear, with controllability of the internal hydraulic fluid flow by means of a piezo valve. The task in this problem did cover the following issues: design of the device in accordance to the aeronautic requirements, to design an appropriated fluidic duct and the piezo valve head, to develop the control unit, which withstand the timing requirements occurring in the case of the landing impact, laboratory validation of the developed and fabricated devices.

5. to validate experimentally in the laboratory conditions, the landing gears with the active systems for small passenger aircraft (1.1 t) and for small cargo aircraft (8 t).
6. The final task was to perform the field testing of the developed device on the small cargo aircraft.

During the project development two main streams of activities were clearly distinguished: The first group of actions was devoted to the development of the solutions for the MR fluid option – it was called MRF development path. The second group of the project's activities was focused on the development of the actuation system with the piezo ceramic component for the adaptive landing gear – it was called Piezo development path.

4.2 The project's development

In this part of the report the general review of the activities and achievements is given. The description is divided into points devoted to main tasks in the project with putting special emphasis on the main achievements in the field of the topics and the participants involved. More detailed data over the activities and achievements of the particular partners are given in the further paragraph of this document.

4.2.1 Feasibility study, potential for improvement

Partners involved: EADS
MD
IA
IFTR

In this part partners described the state of the art in landing gear design with a particular focus on shock absorbers. It gave an overview on the general design solutions and installation of landing gears into the airframe. An emphasis was placed on the function and calculation of loads acting on oleo-pneumatic shock absorbers, which were the main type of shock absorber considered within ADLAND. One part of this document covered the requirements which were the basis of the shock absorber design, materials used and related future developments within aerospace industry. A brief summary was given on research performed on active shock absorbers up to the moment.

4.2.2 Development of the MRF actuated adaptive landing gear

Partners involved: FhG-ISC – MR fluid production
USFD – MR valve design
CEDRAT – magnetic properties of MRF determination
IA – MR valve integration, testing
IFTR – control system development

The main objective for this task was development of the adaptive landing gear device with the actuation system based on the MR fluids. The range of the completed subjects was very wide. Firstly, it included modification of the MR fluids properties in order to make them possible to meet the aeronautics requirements (FhG-ISC partner). Second large task was development of the design methodology and fabrication of a MR valves and validation of it on a lab-scale model of the MR landing gear (USFD partner). The third task was the design of the fluidic and magnetic circuits for the full scale models of the adaptive landing gears (cooperation: IA, CEDRAT, USFD). The last task in this group of activities was integration of the landing gear model with the developed control system (IFTR) and testing the assembly in the laboratory of IA (IFTR, IA).

The achievements after these activities were: production of a series of types of MR fluids with various viscosities and with high sedimentation stability, establishing of a validated technique for the MR valves design, establishing of a method for design and control of MR devices with taking into account its time delays.

The team has succeeded in implementation of the newly designed magnetic valves into the full size landing gear.

Consecutive steps taken in the MRF active landing gear development:

- Numerical estimation of a potential profit coming out of introduction the active landing gear system
- Numerical modeling of the MR devices, designing methodology of MR devices,
- Manufacturing of a first model of a MR landing gear based on sample landing gear and conducting the tests on a drop test rig at IA laboratories, experimental testing of the prototype shock strut,
- Development of a small drop test stands and scale models of shock absorbers at IFTR, USFD and FhG-ISC laboratories,

- Validation, verification and modification of the scale test rigs in accordance to the obtained results,
- Validation of numerical models with the experimental results,
- Design of the magnetic circuits for MR valves including conceptual MR valve design with a permanent magnet included,
- MR fluid development and manufacturing of samples for the project purpose
- Magnetic characterization of the MR fluid
- Definition of a control strategy for MR shock absorbers under impact loads,
- Development of a control hardware for MR landing gear
- Determining of control timing limitations for MR devices,
- MR landing gear sizing for large scale aircraft
- MR valve with permanent magnet for I23 design and testing
- MR landing gear sizing for small scale aircraft
- Validation of the design methodology of MRF devices against the laboratory tests.

4.2.3 Development of the Piezo actuated adaptive landing gear

Partners involved: CEDRAT – piezo technology, design
 IA – landing gear design, testing
 IFTR – control strategy, control hardware

The main objective of this task was to design and fabricate a piezo valve in order to control the hydraulic flow in the adaptive landing gear. The challenges here were design of the piezo ceramic elements in accordance to the aeronautic requirements, design of the proper fluidic duct in order to obtain the optimal controllability and stability of the system, packaging of the actuation system in to the presently existing landing struts, providing of the control system.

The achievements of that part were two piezo valves designed and fabricated by CEDRAT, two prototypes of the landing gears with the piezo valves – for small passenger aircraft and for small cargo aircraft (IA). The prototypes were tested in laboratory environment of IA after integration with the hardware controller developed in IFTR.

The piezo valve solution was decided to be the option which was further tested on the cargo aircraft during field tests in PZL Mielec.

Consecutive steps taken in the Piezo-valve operated adaptive landing gear development:

- Design and manufacturing of the Piezo-valve head for the model shock absorber – I23 LG,
- Definition of a control strategy for Piezo actuated active shock absorbers under impact loading,
- Conducting of a set of tests with the the piezo actuated model shock absorber I23,
- Design of a strut for Skytruck aircraft,
- Determination of a performance limitations of Piezo control devices,
- Design and fabrication of a high force piezo actuator for the Skytruck landing gear on the basis of experience gained from testing I23 LG,
- Fabrication of a high power drive electronic for tests at IA laboratories
- Testing of the M28 Skytruck adaptive landing gear with integrated piezo valve in laboratory
- Testing of the complete control system in the laboratory
- Field testing of the M28 Skytruck adaptive landing gear with integrated piezo valve
- Field testing of the developed control system for the adaptive landing gear

4.2.4 Development of the control system

Partner involved: IFTR

The objective in this task was to develop, design and fabricate a hardware controller for the adaptive landing gear. The controlled systems were developed in two versions: for MRF development path and for piezo-valve development path. The proposed control strategy was unified for both paths of the development and basically it assumed realization a two phases of the process: recognition of the impact parameters and on-line adaptation of the device. The control hardware system was an electronic logic unit with an integrated part for identification of the landing impact energy.

The achievements of this part were: development and lab verification of the control algorithm for adaptive landing gears, fabrication of a hardware controller for implementation on the aeroplane, implementation of advanced control algorithms on a FPGA platform.

During the project three serious control problems were solved: fast actuation of the Piezo valves, fast actuation of the MR fluid valve and recognition of the impact energy magnitude. Two systems were developed, one of which was devoted to operation in laboratory

environment and was based on FPGA chip and the second one, based on a microchip was used during full scale testing and field testing.

Consecutive steps taken in design of the control and impact identification systems:

- Development of a control strategy for adaptive landing gears in lab on the basis of FPGA platform
- Conducting experiments with real time height measuring system.
- Development of the hardware controller version1
- Development of the control strategies for adaptive landing gear on the small laboratory stand (feedback control with force or acceleration input signals)
- Experimental validation of the control hardware on the full scale model
- Experimental validation of the control hardware on the small cargo airplane during the field test, tuning of the filtering system for the sensing system
- Development of the hardware controller version 2

4.2.5 Laboratory testing

Partners involved: IA
IFTR
CEDRAT
USFD
FhG-ISC

The laboratory investigations in the frame of the project were conducted in two main groups. The first were primary experiments performed in a small laboratory scale, in which the objects were small lab devices. The primary experiments were conducted by USFD, FhG-ISC and IFTR. The second group of the experimental investigation was work done in IA and PZL which included the laboratory tests of the full scale adaptive landing gears and field tests of them.

The results of the small scale laboratory models did allow to perform fundamental research of the smart material's mechanics and to validate the proposed control method's for the landing impact problem.

The designed and fabricated full-scale adaptive landing gears were tested in the laboratories of IA. The experimental objects were: MRF type adaptive landing gear for a small passenger aircraft, Piezo valve type landing gears for small passenger aircraft and for small cargo aircraft. The tests were conducted on a drop test stand with the control and impact recognition

systems integrated. The aim of the tests was to prove the functionality of the fabricated models and to validate the correct operation of the control system.

The experience from the testing of the landing gears in the laboratory was used during field tests of the landing gear.

4.2.6 Field testing

Partners involved: PZL
IA
IFTR

M28 Skytruck, small cargo airplane was chosen for the field tests of the adaptive landing gear, as the most promising design after the laboratory tests.

The field tests took place in the PZL Mielec airport. The tested plane was M28 Skytruck with the adaptive main landing gear mounted on one side.

The tests included: taxiing on a paved runway, taxiing on an unpaved runway, taking off, landings.

4.3 Main achievements of the project and conclusions

In the frame of the project development a high effort was put into fundamental research of effects and techniques of active shock absorber control for landing gear application. The most significant achievements were:

- development of a series of types of MR fluids,
- MRF behaviour analysis and prediction,
- design of MRF damping device,
- lab and full scale tests of MRF damper,
- development of piezo actuated damping valve shock absorber,
- development, design, and test of corresponding control equipment.

Meaningful is fact of conducting of the first Flight test of a piezo actuated adaptive aircraft shock absorber prototype in EU and worldwide.

5 Impact on the industry branch, impact on the research sector

5.1 FhG-ISC

In the ADLAND project FhG-ISC developed various new magnetorheological (MR) fluids for the potential application in the shock absorber of a landing gear as well as two damping devices, a drop test facility with a modularly designed shock absorber and a vibration damper with fail-safe characteristics.

FhG-ISC could strongly extend its know how concerning formulations of MR fluids aimed at special profiles of application-relevant properties. Several new compositions based on different material components were elaborated and evaluated in testing devices. It is expected that this profound knowledge will also be exploited for other applications in future R&D projects.

Further expertise with a high potential could be gained in the magnetic circuit design for magnetorheological dampers. A new damper which shows an excellent performance in terms of controllability was developed. This device offers a very good base for the development of new MR technology in the field of impact absorption and vibration damping.

The results achieved in the project will be exploited in a patent application and disseminated in several publications.

5.2 CEDRAT TECHNOLOGIES

Cedrat Technologies has developed the two technologies and effectively took benefits from the ADLAND projects to develop its knowledge and its assessment on the piezo technology through the field test performed in the project.

Cedrat Technologies developed an original magnetic circuit for a MRF fluid damped that is patentable. Cedrat Technologies intends to further develop concept based on MRF in the future.

The piezo technology was used both in laboratory and field tests and showed its effectiveness (no failure, compatible with the application constraints, short reaction time, ...). The concept is also patentable. Moreover, it is likely that the field test (the piezo technology has been used on a aircraft for a field test) will have some indirect effects for the dissemination of the technology. Cedrat Technologies intends to have R&D project in aeronautic.

The patentability of the development carried out in the project is currently under deep examination.

5.3 USFD

As a result of the ‘original contribution’ generated from USFD’s research activities, three conference papers and two journal papers have been published/submitted. Details of these publications are given in Table 1.

The ADLAND project has also provided post-graduate training for David Batterbee, who has recently been awarded with a PhD, and is now employed on a two year post-doctorate position. Technical training has also been provided for Jamie Booth, who is now employed on further research contracts at The University of Sheffield.

Title	Authors	Journal/Conference	Annex:
Design and performance optimisation of magnetorheological oleopneumatic landing gear	D C Batterbee, N D Sims, R Stanway, Z Wolejsza	<i>SPIE, Smart Structures and Materials 2005, San Diego, California, USA</i>	
Magnetorheological landing gear. Part 1: A design methodology	D C Batterbee, N D Sims, R Stanway, Z Wolejsza	<i>Submitted to Smart Materials and Structures</i>	USFD 6
Magnetorheological landing gear. Part 2: Validation using experimental data	D C Batterbee, N D Sims, R Stanway, M Rennison	<i>Submitted to Smart Materials and Structures</i>	USFD 7
Magnetorheological landing gear design: A feasibility study for small and large-scale aircraft	D C Batterbee, N D Sims, Z Wolejsza, A Lafitte	<i>ISMA 2006, Leuven, Belgium</i>	USFD 9
Semi-active Landing Gear Incorporating Smart Fluid Damping: A Performance Comparison of ER and MR Fluids	D C Batterbee, N D Sims, A Lafitte	<i>IMAC XXV, 2007, Orlando, Florida, USA</i>	USFD 10
Magnetorheological shock absorbers: Modelling, design, and control.	D C Batterbee	<i>PhD Thesis</i>	Available on the ADLAND website

Table 1: Summary of USFD’s publications.

5.4 MD

From an industrial point of view, ADLAND project succeeded in proving the feasibility of “near real-time” semi-active control of damping. This project paved the way for semi-active control of shock-absorbers. However a lot more has to be done. The piezo-electric actuator

seems more advanced and promising than the MRF system. The main drawback of the MRF is its specific weight, from fluid itself but also from all the needed magnetic material.

Moreover impact control is only one possible application. Maybe it's not the best one to fully use the intrinsic qualities of the system. Vibration control, that will require a lower quantity of fluid, could be a better application for MRF. This way has to be explored to discover the potential savings.

The ADLAND project helped Messier-Dowty to discover these new technologies and develop its knowledge about them.

6 Descriptions of each partner's activities and achievements

6.1 IFTR: Institute of Fundamental Technological Research

The main task of IFTR in the project was to develop, design and fabricate the control system for the adaptive landing gear.

The control system for the adaptation of a landing gear is a challenging task to design. The designer must take into account a series of aspects that cannot be neglected, that are result of the specificity of aircrafts operation. The control system design must consider the following three important problems.

The first problem is related to the duration of the phenomenon. In general, the landing impact lasts between 50 to 200 ms depending on the size of the landing gear and the landing conditions. This short time period makes it difficult to implement control strategies effectively as present actuators are not able to respond fast enough. The fastest actuators collaborating with hardware controllers are able to execute one control loop with approximately 4 ms delay. This means that the system is able to update the control signal around 13 times in the case of a 50 ms impact duration. If it is assumed that 4 or 5 loops would be consumed for recognition of the process conditions, then the remaining period would be insufficient for execution of an efficient control process. Another important factor is that the impact is random in nature. In contrast to a harmonic process, it is not possible to characterize an impact on the basis of one period and to implement the proper control law for the following periods of the process duration. In these circumstances it is necessary to apply a control system in which the feedback control strategy is assisted by an impact energy prediction unit. The energy prediction unit would process the sink speed, position, and the actual weight of the aircraft in order to provide an estimate of the coming impact.

Estimation of the aircraft's sink speed is presently achieved using pressure based altimeters. However, much higher accuracy is required for the above purpose. For this vertical velocity measurement (sink speed), the following instruments are considered to be feasible: photo laser, low power radars, ultra sound sensors. The measurements of the actual mass of the aircraft can be conducted in a passive or an active routine. The passive routine consists of

storing data about the aircraft's take-off mass and its centre of gravity. This requires, an estimation of the fuel consumption before landing. The active method of mass estimation can be realized via introduction of the Real Time Mass Identification system 11, which enables identification of the actual weight loading each landing gear strut. When Real-Time Mass Identification is used with an integrated sink speed measurement, it is possible to assess precisely the energy of the coming impact for each wheel. This configuration would make it possible to establish the optimal strategy for active energy dissipation of the whole structure.

The second problem to be considered for the design of the active landing gear is calculating the exact position of the aircraft during landing in relation to the runway. The position is important since the impact energy dissipation process must be significantly different depending on whether the plane lands on one or both main landing gears. The position of the aeroplane is continuously monitored during flight by gyroscopic sensors but the measurements give the absolute outcome, and it is not possible to calculate the exact position of the aeroplane in relation to the surface of the runway. One method of conducting these measurements is to integrate the height sensors with sink speed sensors on each landing gear. This would enable monitoring of the 6DoF position of the aeroplane so that the landing gears can adapt more effectively to the coming impact.

The third problem that must be considered in the design of active landing gears is the spring back forces that occur during touchdown. Spring back forces come from the acceleration of the wheels after contact with the runway surface. The circumferential velocity of the wheels must be equalized with the horizontal velocity of the aircraft. The horizontal component of the load vector acting on the landing gear causes bending of the strut. The deflected strut springs back rapidly and increases seal friction within telescopic oleo-pneumatic landing gears. This phenomenon introduces significant friction damping, which acts parallel to the oleo damping generated by the orifice. The influence of friction damping is very difficult to predict since it varies with each landing and is dependent on the horizontal speed of the aeroplane, the sink speed of the aeroplane, runway adhesion, temperature and the exact 6DoF position of the aeroplane. Prediction of the exact value of friction is a very complex task and the result can be estimated with significant error. In the case of a control system for which the damping force would be treated as an input, the safest and most convenient solution is to use a sensor that measures the total force generated by the landing strut, and to modify it with the adaptive component. Control systems used in such a routine were analyzed and tested in the

laboratory 12 but the measurement of the total axial force in the strut is a challenging problem due to technological limitations in real applications.

According to the presented discussion the preliminary requirements for the active landing gear control system are as follows. In connection with the fact that the impact process duration does not exceed 50 ms in the most severe cases, the control system must have the capability of recognizing the impact energy in advance in order to adapt the system before the process starts. The second requirement is that the system (actuator + sensors + control hardware) must have the capability to update its state within 4 ms in order to keep the control system performance efficient. The third established requirement for the control system refers to the feedback signal on which the control is based. The signal must describe the total reaction of the landing gear during the process. One of the possible signals can be the total interface force between the strut and the aircraft structure 12, but the force sensor is difficult to assemble from a technological point of view. In the case of landing gear shock absorbers it is possible to mount a pressure sensor of the hydraulic fluid inside the chambers. However, the pressure signal can give only information about the hydraulic shock absorbing force acting on the structure. The signal does not give information about the frictional forces, tire forces or the spring back phenomenon. The parameter which gives absolute information over the reactions of the fuselage and landing gear is the acceleration measured at the top of each landing gear. This signal was chosen as the input signal for the developed control system.

Researchers of IFTR fulfilled the following tasks in the project, in accordance to the mentioned specification of objectives:

- Numerical modeling of landing gear and simulation of a wide spectrum of landing cases with statistical analysis of the results
- Design and fabrication of a monitoring and determination system for sink speed of aircraft

- Prototype of the ultrasonic sink speed sensor



- Control device for active landing gear based on piezo valve (lab tests + field tests)

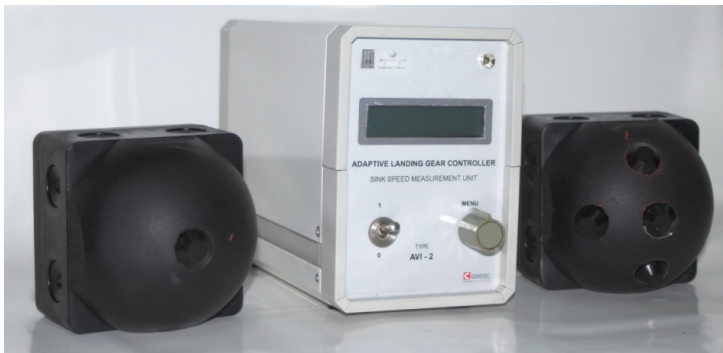

- Control device for active landing gear based on MRF technique (lab tests)

6.2 EADS: European Aeronautic Defense and Space Company

As an industrial end-user, the main role of EADS was to assist the other partners by providing requirements, data and evaluate the adequacy of the developed technologies with landing gear requirements and constraints within the field of military aircrafts.

Participation of EADS contained the following fields:

- Coordination of the state-of-the-art and requirements document writing,
- Provision of data from several aircraft types,
- Evaluation of the developed technology
- Evaluation of potential markets

6.3 PZL Mielec: Polish Aviation Factory Mielec

Within the participation in project ADLAND, PZL (Polskie Zakłady Lotnicze) were engaged into realization of assignments in Work Packages WP3 and WP6.

In WP 3 Work Package the PZL accomplished the assignment No. 5 entitled “MANUFACTURING of FULL SIZE MODEL SHOCK ABSORBER ADLAND”.

In WP6 Work Package the PZL were the executor of assignment No. 2 entitled “FLIGHT TESTS”.

During the accomplishment of task No. 5 in WP 3 Work Package the PZL executed following works:

Because of the fact that the IA was the author of design documentation of project ADLAND, the documentation was adapted to the PZL standards. The adaptation included producibility analysis of the structure, the selection of standardized parts used in PZL as well as working out of Installation Documentation for under-carriage installation on the airplane, in relation to planned tests in flight.

Because of the fact that the project concerned quite a new design, the static strength checking calculations were executed. There was also worked out the programme of static tests to which the main landing gear with modified shock absorbers were submitted in order to confirm the fulfillment of FAR 23 regulations requirements.

The production preparation range included the following:

- technological documentation was worked out – there were chosen indispensable workshop tooling as well as necessary special tools .

Pre- production activities required technical arrangements with subcontractors of special processes (like electron beam welding) as well as the order placing for the delivery of materials and completed articles.

Within the accomplishment of WP 3 Work Packet, four assemblies of main landing gear were produced together with shock-absorbers and indispensable acceptance tests were conducted. The following assemblies of main landing gear were passed on;

- 1 assembly for dynamic tests in IA,
- 1 assembly for tests of static strength in PZL,
- 2 assemblies for tests in flight in PZL.

Moreover, there was made a research stand as well as static strength tests were conducted fulfilling the requirement of FAR 23 regulations, which enabled the installation of main landing gears and the admittance of objects to flight tests.

Within the accomplishment of task in WP 6 Work Package the PZL executed following works:

Having obtained the report concerning the dynamic tests of the main landing gear, which were conducted by the IA, the main landing gears with the classical system of shock absorption were installed on PZL M28 "Skytruck" Airplane in order to execute flight tests.

There was a positive assessment of the shock absorption system work and the whole under-carriage. This enabled the preparation of airplane to appropriate flight tests of the smart energy absorption system based on controlled actuator.

Within the object preparation to tests, the shock-absorber with piezo-valve was installed in right main landing gear of airplane, leaving the classical oleo pneumatic shock absorber on left landing gear classic. The airplane was provided with measuring/recording equipment as well as with the descent rate measurement system.

Tests were conducted in flight, beginning from taxiing and take-offs over concrete airstrips, then over grassy landing fields. The operation of shock absorption systems during turnings was also evaluated.

In the second part of flight tests, four flights were executed with landings at different rate of descent from almost zero to about 1,5 m/s.

The report No. PRG-7/784/M28/2006 was worked out on the basis of conducted tests.

Detailed results of tests and recorded parameters are included in Report No. 16/BZ/06 worked out by the IA.

According to pilots' qualitative assessment, the energy absorption systems, equipped both with the classical shock absorber (oleo-pneumatic) and the shock-absorber with actuator worked properly and did not cause any unfavorable reaction.

According to the subjective opinion, there were perceived no differences in functioning between the shock absorption systems of the left and right under-carriage.

Before the application of the active shock absorption control system to the serial production, it would be indispensable to improve it and conduct complex system tests relating to its functional reliability.

6.4 IA: Institute of Aviation

Specialists from L/G Departments of Institute of Aviation (IA) have used their R&D experiences of passive Landing Gears R&D activity to develop new idea of Adaptive Landing Gear.

As first work was prepared and published by IA state of the art description „ State of the Art in Landing Gear Shock Absorbers” written in cooperation with: MD, EADS, IFTR.

For next R&D works were took into consideration: one telescopic type Landing Gear based on nose landing gear of I-23 airplane (take-off mass 1150 kg) - as first option and not existing lever type landing gear which would be considered for airplane SKYTRUCK (take-off mass 7500 kg) - as second option.

First option with a telescopic type L/G (Fig. 6.4.1) allowed to check influence of friction forces generated during landing process.

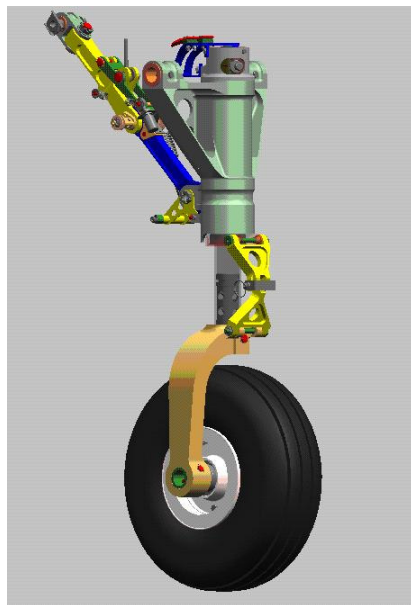

Fig. 6.4.1. I-23 telescopic type nose L/G

In first 1-2 ms the friction force between piston and supporting sleeve reaches max. value, then appear spring back phenomenon and horizontal force changes from max. to 0 and again friction force reaches max. value but with opposite direction. This force has influence on behavior of full structure of L/G and should be taken into consideration for analyzing total process of input.

Second option as lever type of L/G allowed to avoid influence of friction forces on full landing process acting in shock absorber in the L/G structures. Shock absorber is applied here as a separated subassembly which can be quickly mounted and dismounted. Such L/G didn't exist and IA had to design completely new main landing gear with new adaptive shock absorber.

To do it correctly at first nose L/G of I23 with MR Fluid and with piezo actuators had to be considered and checked.

As first tests were performed drops of nose L/G of I-23 with classic – passive version of S/A. Results were needed for predicting behavior of such L/G in simulation process (IFTR, USFD).

Real results of first tests allowed to verify numerical analysis made by IA partners. After obtaining tests results of traditional version of L/G, were took into next tests the same nose L/G of I-23, but with MR Fluid produced by FhG-ISC (AD213, AD275).

For generating damping forces was designed and manufactured by IA new special magnetic head. First solution was very simple - consist of coil with core made of ARMCO. The dynamic tests showed a lot of problems to be solved. The most important was generating strong magnetic field and change it quick enough with approximately 4 ms delay. The simple solution (with only coil) wasn't good enough.

Another problem that was recognized during first tests was sedimentation problem not only between oil with oil with iron particles, but inside of volume of MR Fluid (density changes vs. deep) when fluid wasn't shaken. This phenomenon was presented by IA in additional special prepared tests.

Another solution of application of MR Fluid was proposed by CEDRAT TECHNOLOGIES. New head with permanent magnet of shock absorber was produced and IA after mounting it inside of I-23's shock absorber performed tests. During tests was recognized another phenomenon of MRF behavior. Strong magnetic field existing in the gap between head and piston (gap of flow) changes MR Fluid into solid and stops the flow.

Shock absorber didn't work correctly and every drop test the obtained result was different. Generated forces reached dangerous values for the L/G structure.

As parallel path was developed solution with piezo-actuator mounted inside of shock absorber of I-23 nose L/G (Fig. 6.4.2).



Fig.6.4.2 Piezo-actuator mounted inside of supporting tube of S/A (I-23)

Damping head with piezo-actuator was mounted in shock absorber and filled with classical AEROSHELL FLUID. The first solution with such a head didn't work correctly and after redesigning, second head was tested with success.

During these tests was checked control system too, and a lot of problems were recognized by IFTR.

After tests of I-23 nose landing gear with MR Fluid and with piezo-technologies, the second technology was chosen as a solution that should be developed and used in new developed SKYTRUCK's main L/G.

IA has designed new main L/G (Fig. 6.4.3) for SKYTRUCK airplane with new adaptive shock absorber with damping head with new piezo-actuator PPA80XL (Fig. 6.4.4).

This piezo-actuator was developed and produced by CEDRAT TECHNOLOGIES.

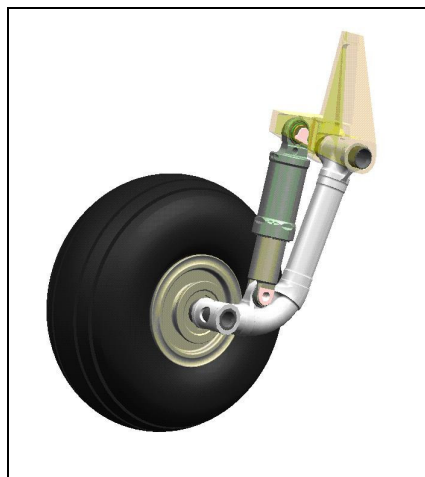

Fig. 6.4.3. New main landing gear with new adaptive shock absorber for SKYTRUCK airplane.



Fig. 6.4.4. Damping head with new piezo-actuator PPA80XL for SKYTRUCK

The structure of the head was designing by IA and produced by PZL.

Drop tests of new L/G were performed in IA (Fig. 6.4.5).



Fig. 6.4.5. New main L/G with adaptive shock absorber during drop tests in IA.

Control system developed by IFTR was used and tested during these tests. Since there was no possible to execute control process, prediction with data of parameters were determined for landing gear of airplane such as: attitude, mass distribution, vertical and horizontal velocity for landing process. Such prepared “road map” was a basic data for control system prepared for flight tests on real airplane.

Second prototype of SKYTRUCK’s main L/G with adaptive shock absorber was prepared for application on real airplane and mounted to the structure of the SKYTRUCK (Fig. 6.4.6)



Fig. 6.4.6. Second prototype of SKYTRUCK's main L/G with adaptive shock absorber mounted to the structure of airplane.

Field and flight test program was prepared by IA, PZL, IFTR.

Field and flight tests were performed in PZL-Mielec and showed that L/G with adaptive shock absorber could work correctly.

To verify results of field and flight tests the L/G was disassembled from airplane and tested once again in Laboratory of IA. The basic parameters used as an input for control system were verified.

Results of all our activity showed that the biggest problem for consideration and solving in future works is response time (5-6 ms is too long).

First solution with MR Fluid need lot of additional design and simulation works, but without permanent magnet installed inside of shock absorber.

ALG concept has a big possibility to be applied in a lot of alternative techniques of realization.

Every structure which is responsible for dissipating energy can be designed based on idea of ADLAND. Especially crash systems of helicopter that should be designed in accordance e.g. with MIL-1290 Standard should consist of special L/G structure and special fuselage structure and special seat structure.

For second level of impact velocity (MIL-1290) , about 50 % of total energy should be absorbed by L/G and another 50% is dissipated by specially designed structure of fuselage (crash structure) and specially designed structure of seats (crash structure, too).

During impact process (crash) ALG – ADLAND concept can increase about 20% of max. crash vertical velocity considered up to now and decrease number of serious injuries of people during the crash.

6.5 FhG – ISC: Fraunhofer-Institut fuer Silicatforschung

The main task of FhG-ISC in the project was the development of magnetorheological (MR) fluids with properties which meet the requirements derived from the application in the shock absorber of a landing gear. An MR fluid is a suspension of magnetizable particles dispersed in a carrier liquid and stabilized with additives, whose consistency can be controlled by a magnetic field in real time. This behavior gives MR fluids an outstanding potential for an improved impact absorption. Most relevant technical requirements on the MR fluid for this purpose are

a large shear stress in the magnetic field in order to achieve high damping forces of the shock absorber,

a low base viscosity without applying the magnetic field, which results in a wide variability of the damping force,

a good sedimentation stability of the magnetizable particles and, even more important, a redispersibility which allows an easy remixing of the particles in the shock absorber,

a moderate increase in the base viscosity at low temperatures (down to -31 °C) in order to ensure the operability of the shock absorber at all landing conditions.

In the project various MR fluids which show excellent property profiles were developed. These MR fluids based on different material components (magnetizable particles, carrier liquid, additives) were characterized in terms of their relevant properties. Fig. 6.5.1 shows the increase in the shear stress of these MR fluids with rising magnetic flux density. The results are compared with the data of a commercial MR fluid. In Fig. 6.5.2 the corresponding viscosity curves of the same MR fluids are revealed. Fig. 6.5.3 shows the sedimentation stability of the MR fluids. Therein the sinking of the interface between the turbid suspension and the clear oil phase in the glass tube above of the MR fluid sample is visualized. The data was recorded over a standing time of two months. Finally, Fig. 6.5.4 gives the dependence of the base viscosity on the temperature at low temperatures. The conclusion from these results is that the new MR fluids have very promising properties for the intended application in shock absorbers. Selected samples of the MR fluids were delivered to the project partners for tests in their devices.

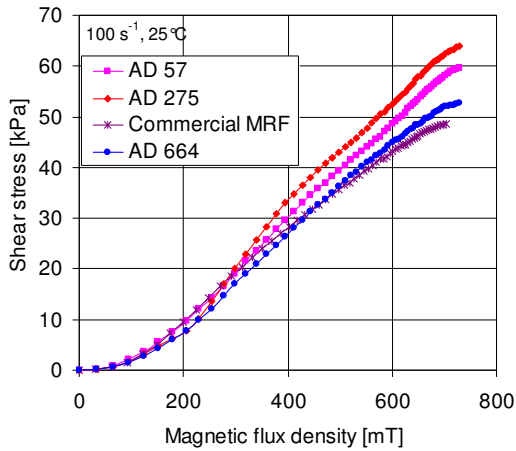

Fig. 6.5.1: Dependence of the shear stress of various MR fluids on the magnetic flux density

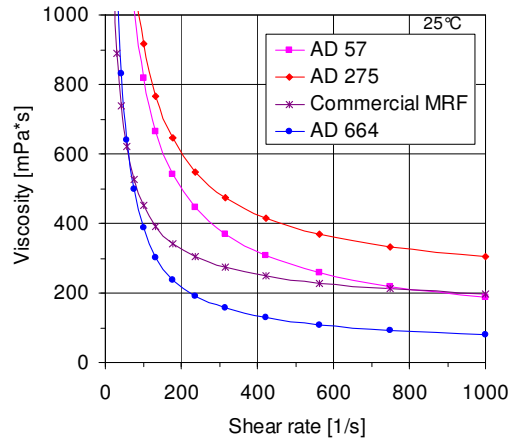

Fig. 6.5.2: Viscosity curves of various MR fluids vs. shear rate

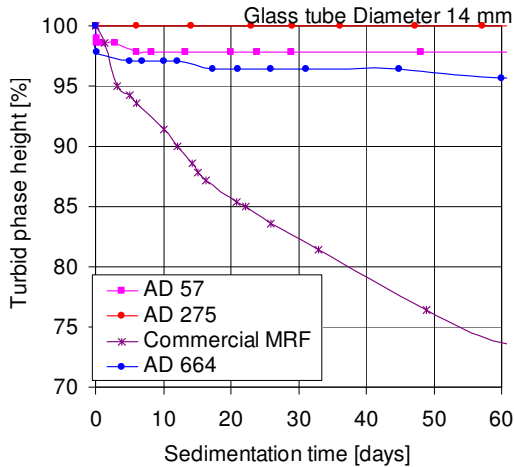

Fig. 6.5.3: Sedimentation stability in terms of the height of the interface between turbid and clear phases in the suspension vs. time

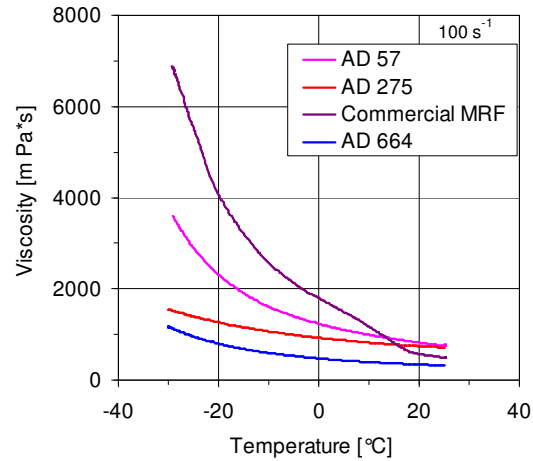

Fig. 6.5.4: Dependence of the viscosity of the MR fluids on temperature at a constant shear rate of 100 s^{-1}

Another task of FhG-ISC was the development of a special drop test facility with a modularly designed shock absorber which allows investigations on the new MR fluids under application-near conditions (see Fig. 6.5.5). With this facility it is possible to perform drop experiments with masses up to 79 kg and impact velocities of more than 5 m/s. The investigations yielded valuable information about the behavior of several MR fluids with different compositions and supported the MR fluid development. The long-term evaluation of one of the MR fluids (AD 275) in the shock absorber of the drop test facility emphasized its very good properties. Furthermore, a new magnetorheological damper with a special design of the magnetic circuit which ensures a good fail-safe behavior was designed, manufactured and tested. The evaluation was conducted with a dynamic testing machine at the University of Applied Sciences in Schweinfurt. The investigations gave very promising results concerning the

controllability of the damping force in a wide range of forces up to 4 kN. The MR damper was also used to evaluate the performances of various MR fluids in comparison with each other. Measurements of the long-term behavior of the MR fluid AD 275 were successful, as they showed nearly no change in its performance over a period of 5 weeks. This new MR damper will serve as the base for further developments of MR devices in the future.



Fig. 6.5.5: Drop test device with shock absorber

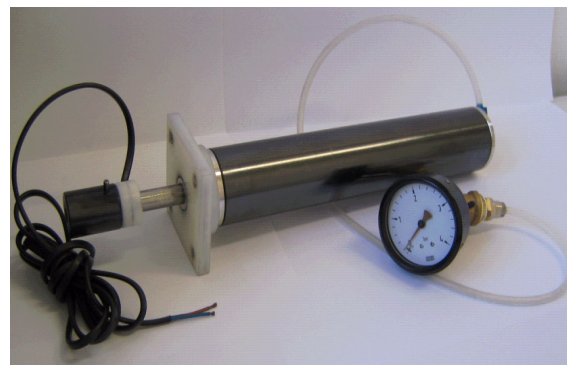

Fig. 6.5.6: MR damper with fail-safe behavior

6.6 CEDRAT Technologies

Cedrat Technologies has worked on the two technologies used in the ADLAND project to control the damping of the landing gear shock absorber: The piezo valve and the Magneto-Rheological Fluids (MRF).

The first implemented technology has been the piezo technology.

After a validation of the component compatibility in the shock absorber environment, Cedrat Technologies designed, manufactured and assembled a piezo valve, which is based on a PPA80L (80 μ m – 3500N), for the I23 nose landing gear. The control of the voltage on the piezo element allows controlling the orifice size of the shock absorber. As the damping of the shock absorber is linked to the control of the orifice, the damping of the shock absorber can be adapted in real time with a time response about 15 ms. (cf. CEDRAT annual report year 1)



Figure 6.6.1 : Device after integration

Tests in laboratory showed a significant control of the damping coefficient thanks to the driving of the piezo valve. The piezo valve technology has been validated to control the damping of aircraft landing gear.

The success of the technology on the I23 landing gear allows contemplating this technology for large aircraft: the Skytruck aircraft. Cedrat Technologies designed a new stronger piezo (PPA80XL) for this larger aircraft with high performances: blocked force about 7000N - stroke about 80 μ m.

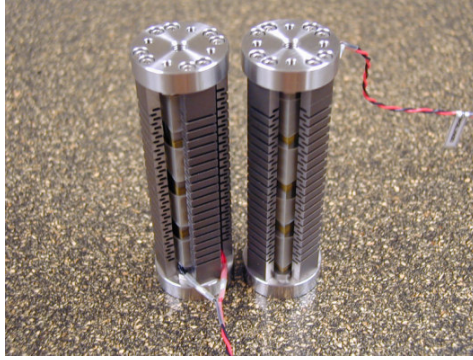

Figure 6.6.2 : *PPA80XL*

An electronic power supply (*LA75C*) was provided to supply the *PPA80XL* and decrease the time response to about 3.4 ms. (cf. CEDRAT annual report year 2)

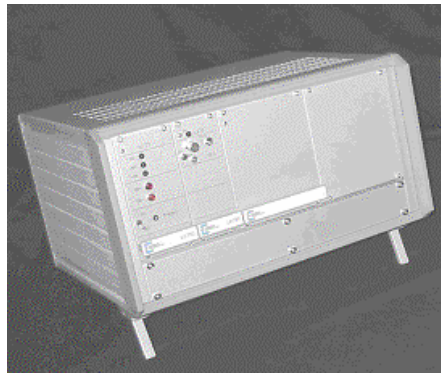

Figure 6.6.3 : *LA75C*

This new piezo actuator allows controlling the orifice size of the shock absorber for large airplanes. Laboratory tests validated the operating and hardness of the components. The success of the Flying test showed the possibility of an industrial used. (cf. CEDRAT annual report year 3)

The second implemented technology has been the Magneto-Rheological technology.

Cedrat Technologies designed different magnetic structures in order to guaranty a fail-safe operating and to minimise the power consumption.

The magnetic finite element models achieved thanks to FLUX software allow designing an optimised magnetic – fluidic structure. (cf. CEDRAT annual report year 1)

In order to master all required material models for our computation, Cedrat Technologies characterised magnetic materials used in the device thanks to a specific designed measurement material. The soft materials and magneto-rheological fluids were characterised. (cf. CEDRAT annual report year 3)

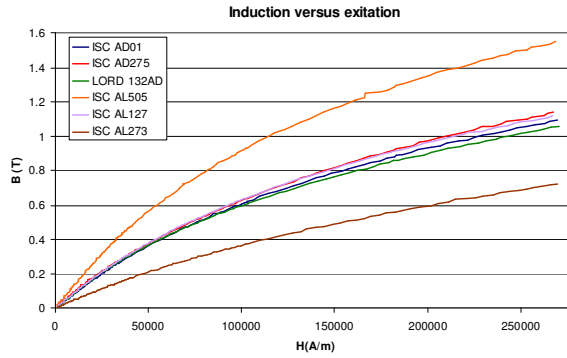

Figure 6.6.4 : *B-H curve of different magnetic fluids*

The optimised structure was manufactured, assembled and validated. (cf. CEDRAT annual report year 2)

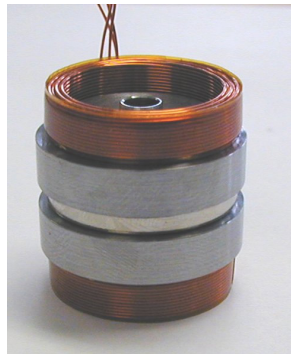

Figure 6.6.5 : *Central parts of magnetic device*

Tests in laboratory showed a significant control of the damping coefficient thanks to the driving of the coils. The MRF technology has been validated to control the damping of aircraft landing gear.

The detailed reports on results achieved by CEDRAT are available in document:

AS1435-2_ADLAND_report_year1.pdf

AS1435-2_ADLAND_report_year2.pdf

AS1435-3-ADLAND-report_year3.doc

6.7 USFD: University of Sheffield

With reference to the flow diagram in Figure 6.7.6, the design philosophy set out by USFD consisted of two key aspects – numerical modelling of MR fluid based devices and experimental validation. On the numerical side (left side of Figure 6.7.6), work began by developing hydraulic device models of conventional landing gears and impact systems. This enabled a better understanding of the landing gear system, and provided a performance benchmark for the MR based designs.

The next stage was to develop techniques for optimising the design of MR valves within the constraints of existing passive landing gears. This involved the development of spreadsheet tool, which permitted the fast and efficient determination of the optimum MR valve geometry for any landing gear. Essentially, this tool permitted the maximum yield stress to be achieved without magnetic saturation and without overheating of the solenoid. One method that was adopted to maximise controllability of the landing gear is shown in Figure 6.7.7. Here, geometrically similar valves are stacked together to maximise the active valve length. This prevented suppression of the active valve length, which occurred due to the constraint on the valve's diameter.

A numerical model of the optimised design was then developed in order to predict the landing impact performance, and hence feasibility of an MR landing gear. The resulting model is shown schematically in Figure 6.7.8. This is a two-degree-of-freedom model that accounts for the inertia of the aircraft and wheel masses, aircraft lift, and the non-linear forces produced by the MR shock strut and tyre. The model of the MR shock strut was designed to be exactly equivalent to the existing passive, except where a geometrically constrained MR valve replaced the conventional main orifice. This enabled direct comparisons with landing impact test data taken from conventional passive designs.

Using data provided by the partners IA and MD, the numerical design methodology was applied to a variety of small (I-23, Dassault Falcon 2000) and large-scale (ATR 42, A320) aircraft. To give an example, a typical shock strut force/displacement response from a landing impact simulation is shown in Figure 6.7.9. The impact response is for a worst-case impact (i.e. maximum sink velocity) on the I-23 nose gear, where the MR yield stress is held at its maximum value. Clearly, the MR design provides an acceptable worst-case response, where the peak force has been minimised by maintaining an equal balance between the damping and gas spring force peaks. Furthermore, through comparison with the experimental

data, the MR valve provides an inherently efficient response in open-loop. For example, the fluctuation in force, and hence the severity of fatigue loading, is less significant.

To illustrate the level of controllability of an optimised design, Figure 6.7.10 presents some open-loop impact responses for a lower sink velocity. As shown, the yield stress can be lowered to minimise the peak force by increasing the shock strut displacement. Furthermore, the maximum yield stress response also gives a good indicator of the large range of controllable force that is available.

The key conclusions from the numerical analysis are as follows:

For both lightweight and large-scale aircraft, highly controllable MR shock struts can be designed.

The impact efficiency is inherently large in open-loop control.

Large scale shock absorbers suffer from high Reynolds numbers. This is undesirable as turbulence may reduce device controllability. Nonetheless, it was found that levered designs are less susceptible, and that higher viscosity fluids can help reduce the Reynolds number without significantly affecting controllability.

The additional mass of a single MR shock strut is fairly high e.g:

I-23 – 1kg

Dassault Falcon Business jet – 12kg

A320 – 18kg

Detailed reports on the above numerical work can be found in Annexes USFD 1(a), 1(b) and 3. Journal/conference publications on this topic can also be found in Annexes USFD 6 and 9. With reference to Figure 6.7.6, the next vital stage of the design process was to validate the methodology using experiments. A prototype MR landing gear shock strut was therefore designed and fabricated using the previously developed numerical methodology. The design of this prototype is described in Annex USFD 3. To test the prototype, a servo-hydraulic damper test facility was also built, which is detailed in Annex USFD 2. A photograph of the experimental setup is provided in Figure 6.7.11, and a schematic diagram of the corresponding MR shock strut is shown in Figure 6.7.12.

Some key results from the experimental validation exercise are presented in Figure 6.7.13, but for a detailed analysis, the reader is referred to Annex USFD 7. Figure 6.7.13 compares the modelled and experimental shock absorber responses for sinusoidal excitation inputs. For a low velocity amplitude (Figure 6.7.13(a)), the model matches the experimental response well, but for higher velocity amplitudes (Figure 6.7.13(b)), the accuracy of the model breaks down. This is due to a quadratic damping or shear thickening effect, which is unaccounted for by the

model. An improved model that accounts for this shear thickening behaviour was therefore developed. The parameters in the new model were updated in line with the experimental tests performed on the prototype shock strut. As shown in Figure 6.7.14, the resulting model of the experimental response is significantly improved. Furthermore, the model was derived in a dimensionless format thus it can be used to predict the damping performance of an entirely different device. Full details of this updated model can be found in Annex USFD 8.

Towards the end of the project, USFD also performed a study to compare the relative performance of ER and MR fluids in landing gears (see Annex USFD 10). One advantage of an ER fluid is that, in contrast to an MR fluid, its density is comparable to conventional landing gear oil. Consequently, there could be a significant mass saving when compared to an MR device. A sizing study was therefore performed to compare the relative performance of ER and MR fluids in landing gears. This was despite the fact that ER fluids require a very high voltage supply as recent advances in aerospace technology may render such voltages as acceptable.

In this study, techniques were developed to optimise an ER valve for the Airbus A320 landing gear. The results were compared to a previously optimised MR device (Annex USFD 4). To overcome the low yield stress of ER fluids, ER valves with multiple duct configurations were investigated to boost controllability. This is illustrated in Figure 6.7.15, where the ducts can be arranged either in series or parallel. However, as shown in Figure 6.7.16, the controllability of an ER device is still inferior to MR shock struts, which have significantly higher yield strengths. The most significant advantage of the optimised ER shock strut was its low mass, which was 12kg lighter than the equivalent MR design.

One promising new development is a high yield stress ER fluid that has been developed by the Hong Kong University of Science and Technology. Yield stress values of up to 130kPa (similar to MR) have been reported, which could enable comparable performances to MR devices. The USFD has purchased some of this fluid and is currently performing experiments to validate its performance.

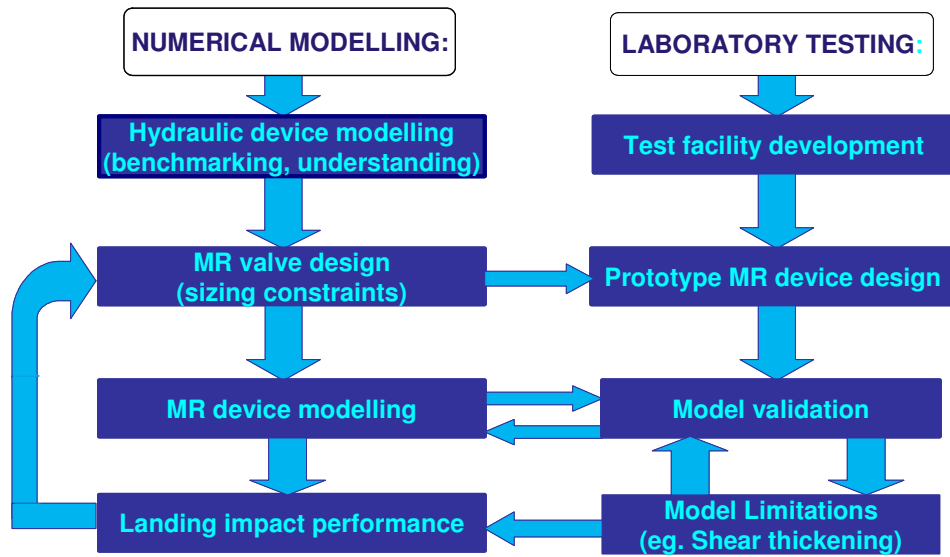

Figure 6.7.6: USFD's Design Philosophy

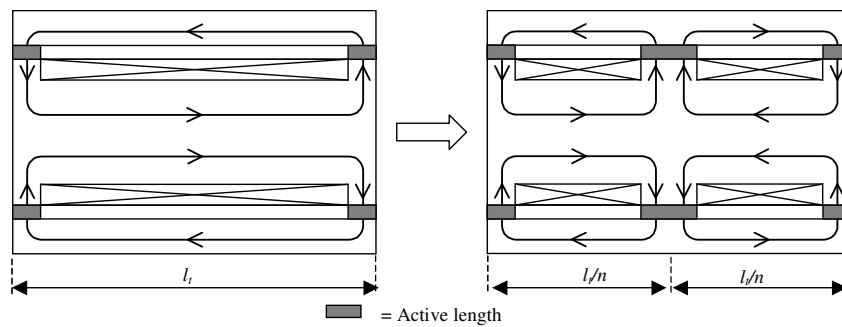

Figure 6.7.7: Improving dimensionless valve length using the stacking method.

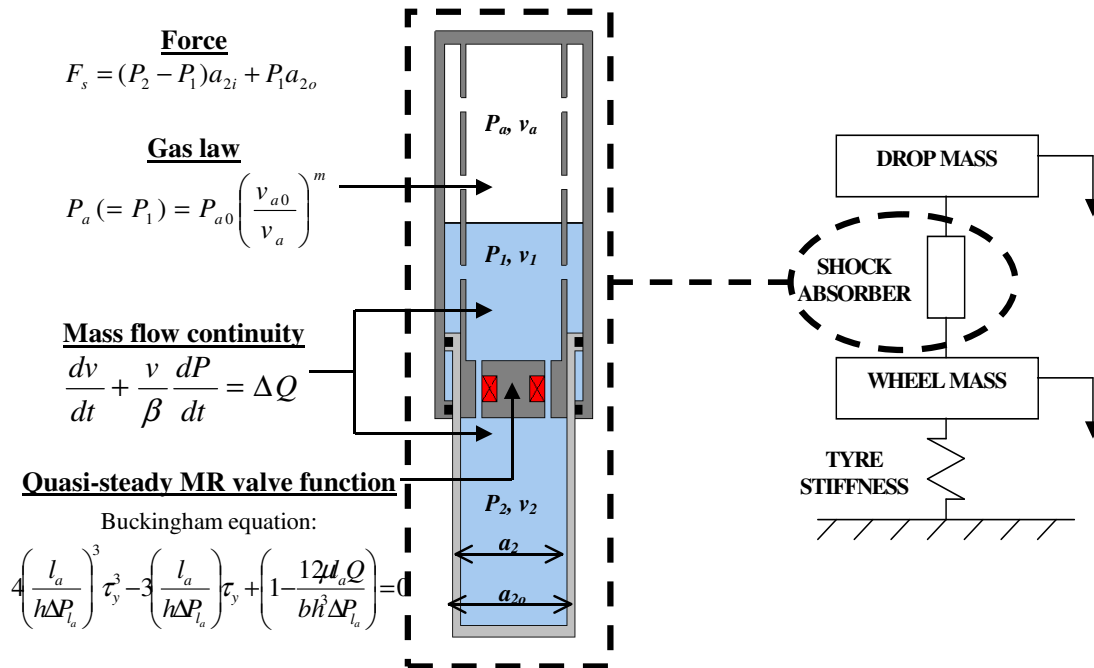

Figure 6.7.8: Numerical model of the MR landing gear impact system

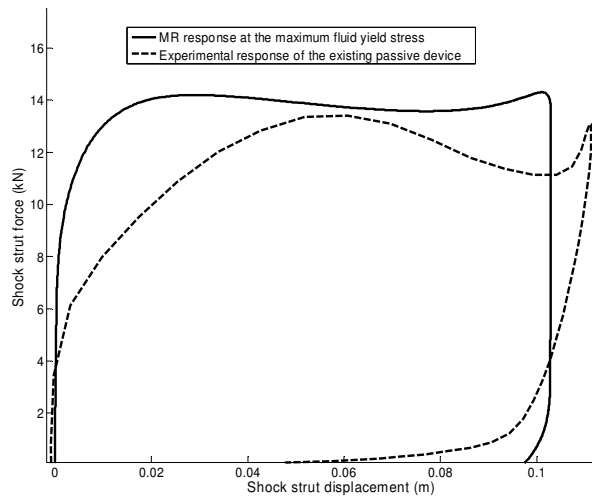

Figure 6.7.9: Worst-case landing impact response of the I-23 nose gear. Sink velocity = 2.43m/s.

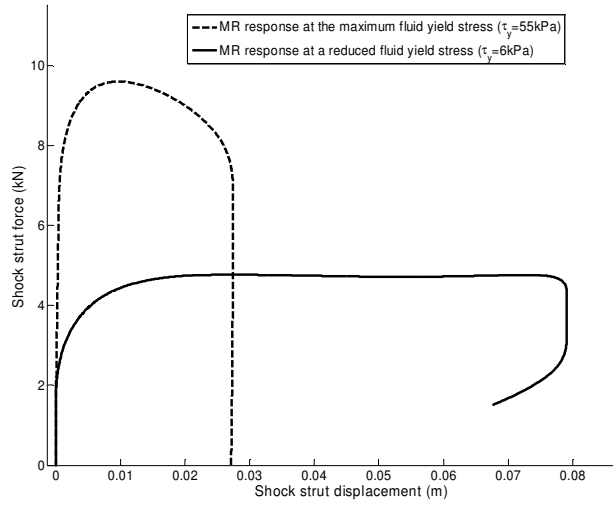

Figure 6.7.10: I-23 landing impact responses with less severe input conditions. Sink velocity = 1m/s.

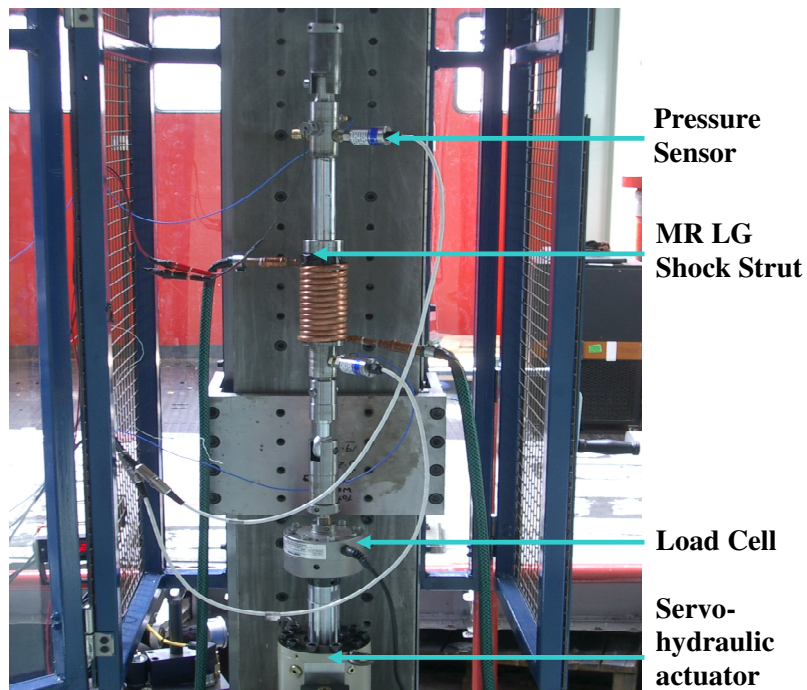

Figure 6.7.11: Photograph of the test facility built at USFD.

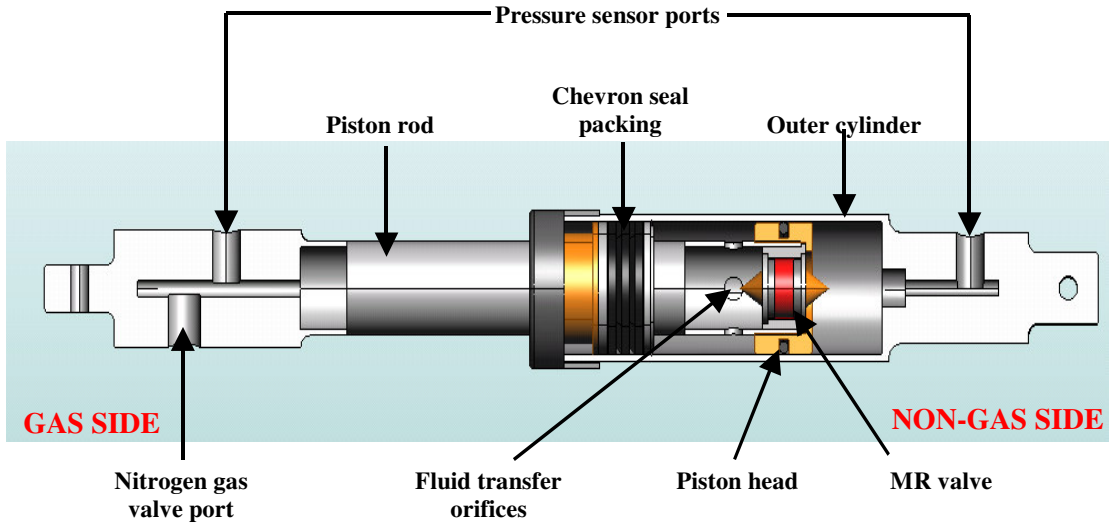

Figure 6.7.12: Schematic diagram of USFD's prototype MR landing gear.

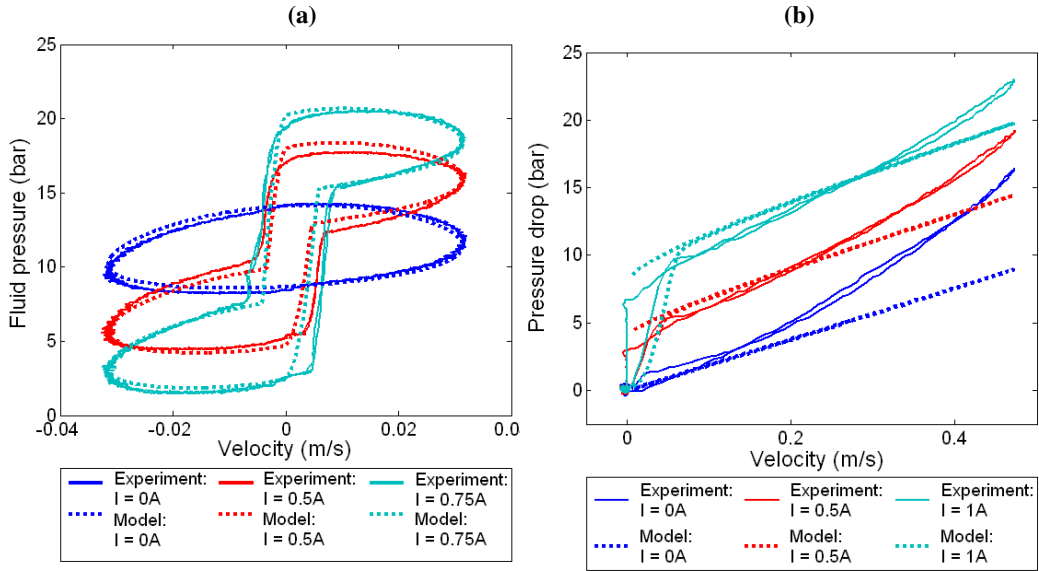

Figure 6.7.13: Sinusoidal shock absorber responses from USFD's prototype landing gear. (a) Low velocity amplitude and (b) high velocity amplitude.

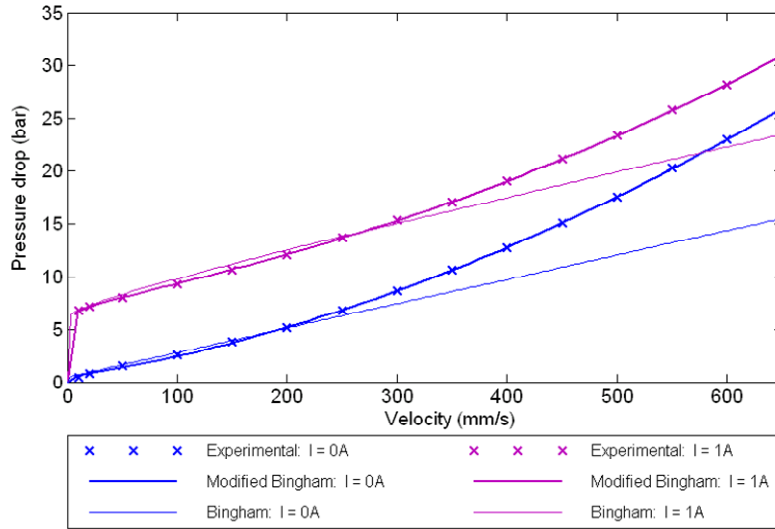

Figure 6.7.14: Predictions of the experimental response using the original (Bingham) and the updated (modified Bingham) models.

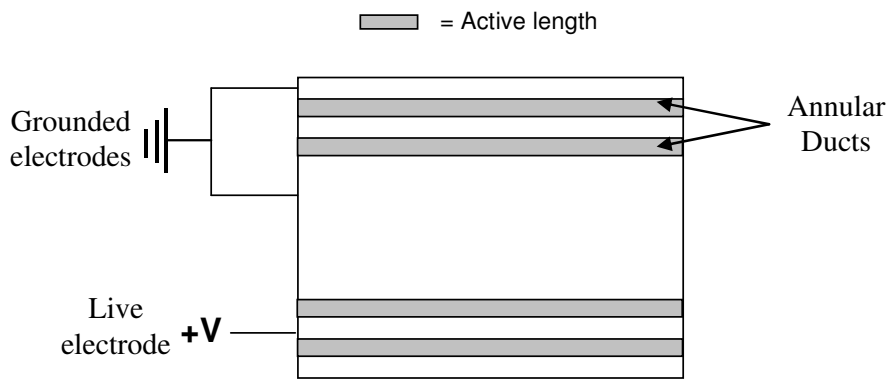

Figure 6.7.15: A multi-duct ER valve – Ducts can be arranged in series of parallel.

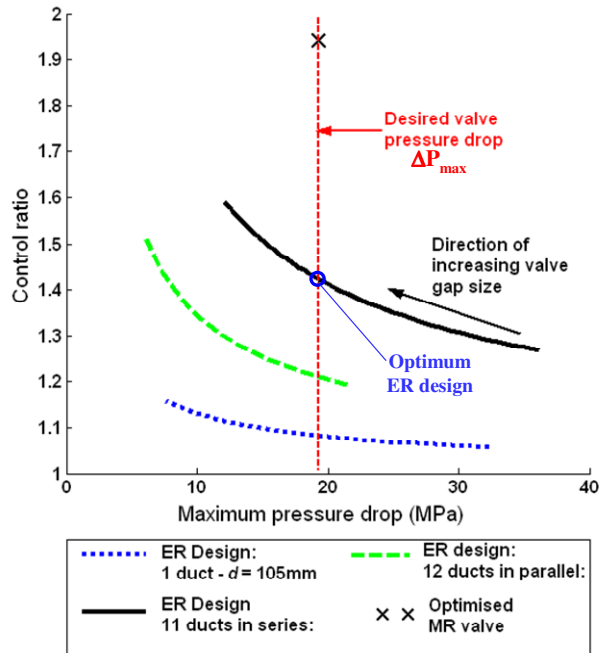

Figure 6.7.16: Performance comparison of optimised ER and MR valves.

6.8 MD: Messier-Dowty

As an industrial end-user, the main role of Messier-Dowty was to assist the other partners by providing requirements, data and evaluate the adequacy of the developed technologies with landing gear requirements and constraints.

More accurately, the participation of Messier-Dowty took several aspects:

- Participation of the state-of-the-art and requirements writing,
- Provision of data from several aircraft types (medium range commercial aircraft, turbo-propelled regional aircraft, business jet).
- Evaluation of potential markets