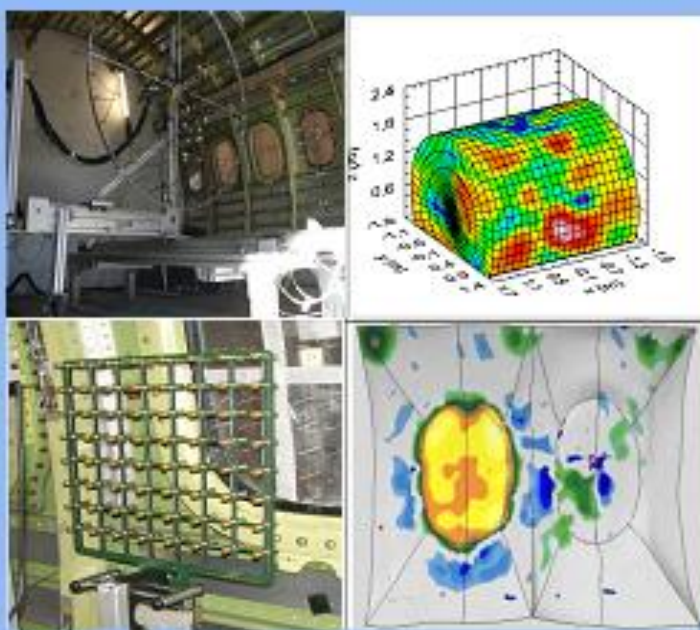




# CREDO



## Cabin Noise Reduction by Experimental and Numerical Design Optimisation





**CREDO**

# **Cabin Noise Reduction by Experimental and Numerical Design Optimisation**

Project no. **AST5-CT-2006-030814**

## **FINAL PUBLISHABLE REPORT**

Project funded by the European Community  
in the framework of the 7th RTD Framework Programme  
2006-2009

Thematic Programme  
***AERONAUTICS AND SPACE***

### **Partners**

Università Politecnica delle Marche

Alenia Aeronautica

Brno University of Technology

Brüel and Kjaer

DASSAULT Aviation

Deutsches Zentrum fuer Luft und Raumfahrt

EADS CRC G

Ecole Central de Lyon

EUROCOPTER Deutschland

Free Field Technologies

Université du Maine

Øedegaard & Danneskiold-Samsøe

Politecnico di Milano

Università di Napoli Federico II

AGUSTA SpA

For further information about the project, please contact the project Coordinator:  
Prof. Enrico Primo Tomasini  
email: [e.p.tomasini@univpm.it](mailto:e.p.tomasini@univpm.it)



## Table of contents

1	Introduction.....	2
2	WP 2 Local measurement and processing procedure .....	4
2.1	Measurement of Entering Sound Intensity.....	4
2.2	Local reverberant field measurement and processing algorithms applicable at high frequencies: 3D Beamforming for trouble shooting and quality control .....	6
2.3	Coupling of scanning laser Doppler vibrometry with reverberant acoustic field local measurements.....	7
2.4	Inverse methods for test-based model identification for fibrous materials .....	10
2.5	Evaluation of the p-u probe technology for local cabin measurements .....	11
3	WP 3 Global measurement and processing procedure .....	14
3.1	Global models and experimental procedures for aircraft cabin in the low-medium frequency range .....	14
3.2	Global models and experimental procedures for aircraft cabin in the medium-high frequency range .....	17
3.3	Global approach for acoustic power flow analysis in helicopters.....	20
4	WP4 Integration and Application to Aircraft Cabins.....	23
4.1	Evaluation of new tools in aircraft environment (in hangar, engine run) and flight tests .....	23
4.2	Application of inverse Global procedures to flight tests measurements.....	25
4.3	WP4 Conclusions .....	26
5	WP5 – Integration and Application to Helicopter Cabins .....	28
5.1	Small cabin mock-up measurements in the BO108 and A109 .....	28
5.2	Sound field reconstructions by global processing.....	31
5.3	Helicopter tests.....	33
5.4	WP5 Conclusions .....	34
6	Results and Conclusions .....	35
6.1	Conclusions.....	39
	References .....	39

## 1 Introduction

Motivated by the aircraft industry's acute need to validate and calibrate prediction models and advanced design tools for the cost-effective design of low-noise cabins, the CREDO project addresses a critical deficiency in the available data by developing technologically viable experimental procedures and analytical tools by which the sound power entering an aircraft cabin can be determined sufficiently quickly, accurately and with the necessary spatial resolution. Owing to the reverberant nature of the sound field in an aircraft cabin, existing methods are categorically insufficient for this task and entirely new methods shall be developed.

Two parallel approaches are pursued. In the first, the sound power entering the cabin is locally extracted from local measurements of the total field. This approach employs a hitherto unavailable microphone array concept: the double layer array, together with purpose-developed processing and procedural algorithms. Local measurement and processing algorithms, which require, at most, only local acoustic characteristics for the determination of the entering power, are developed in Work Package 2. No large scale modelling of the aircraft cabin is required and as such the development is entirely generic and may be applied in any reverberant environment. A local approach is, for example, the determination of the accurate entering acoustic power from a single window in flight. In the second approach, the sound power entering the cabin is determined globally through numerical inversion of measurements throughout the entire cabin using the new experimental tools. This will be achieved with pioneering Inverse Finite Element implementations and groundbreaking Inverse Simplified Energy Methods, developed in close connection with novel measurement technology and algorithms, extended from the local to the global level. Global measurement procedures and associated processing based on inverse numerical methods are developed in Work Package 3. These procedures take into account the reflections in the aircraft cabin by building a global experimental and numerical model of the whole or a large part of the cabin interior and then inverting from measured sound data to the required entering sound power. In contrast to the local, generic approach, this global approach results in models that are specific to a particular cabin application. At all stages in the project, the interaction between local and global approaches and between measurement and processing is exploited to maximum innovative effect.

The successful implementation of the results of these developments is ensured by a carefully designed validation campaign involving ground and flight tests in both aircraft and helicopter cabins.

The project consortium is composed of: Università Politecnica delle Marche (Coordinator), Alenia Aeronautica, Brno University of Technology, Brüel and Kjaer Bruel&Kjaer, DASSAULT, DLR, EADS-IW DE, Ecole Central de Lyon, EUROCOPTER, Free Field Technologies, Université de Le Mans, Ødegaard & Danneskiold-Samsøe, Politecnico di Milano, Università di Napoli Federico II, AGUSTA.

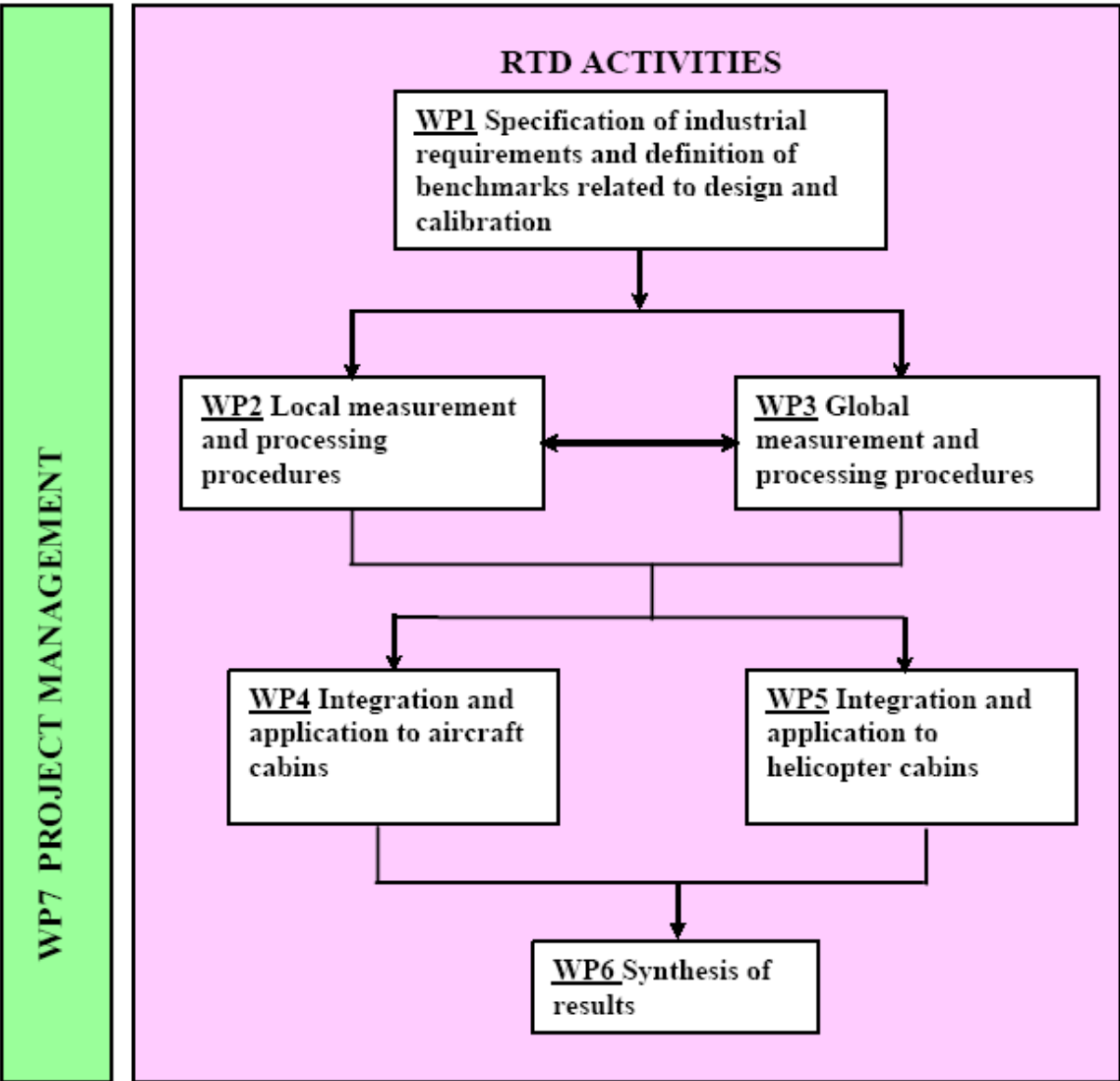


Figure 1. Work Packages flow chart

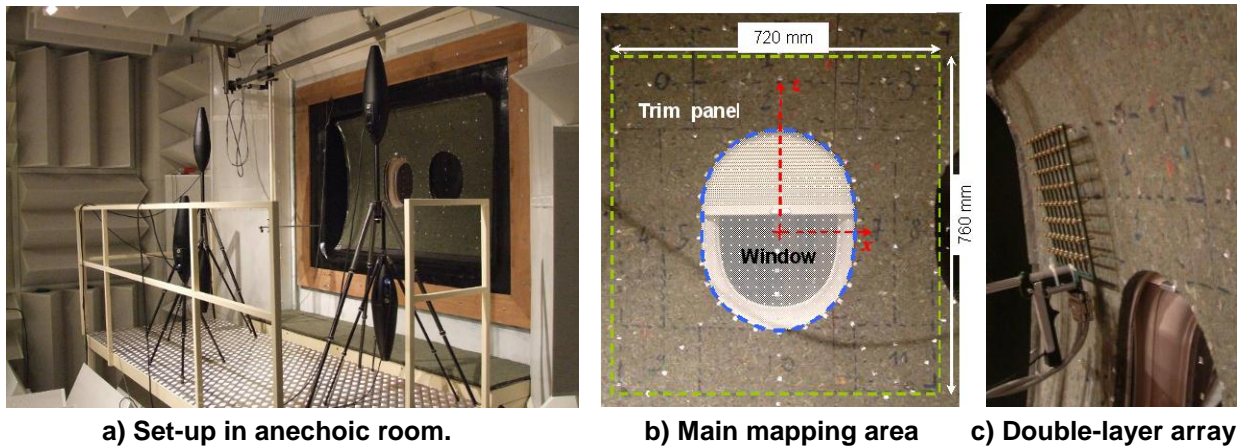
In this report, the results of the development Work Packages (WP2 and WP3), concerning the local and global methodologies (respectively), and the application ones (WP4 and WP5), related to the aircraft and helicopter fields, are reported.



## 2 WP 2 Local measurement and processing procedure

### 2.1 Measurement of Entering Sound Intensity

In some cases it is important to be able to measure not only the total sound intensity on a source surface, but also the components of that intensity due to sound radiation and due to absorption from an incident sound field. The radiated intensity is here defined as the intensity that would be radiated under free-field conditions. On absorbing panels in an aircraft cabin the two components may more or less cancel each other, but still it can be desirable to know the two components, for example in connection with energy flow modelling of the cabin noise. For cabin noise, the radiated field component is the one entering the cabin, so the associated radiated sound intensity will be called also the Entering Intensity. Standard sound intensity measurement with for example a two-microphone intensity probe will only provide the total intensity, i.e. the sum of the entering and absorbed components. Also, the intensity probe measurement will be at some distance from the source surface, while an array measurement allows back-propagation to the source surface.



**Figure 1: Set-up with 5 loudspeakers in Transmission Loss facility at Dassault Aviation, France.**

B&K, ODS and BUT have worked on the establishment of a method to separate the entering from the absorbed intensity of the emitting surface. If the radiated (entering) and incident field components are mutually incoherent, then they will contribute independently to the sound intensity:

$$I_{\text{total}} = I_{\text{radiated}} + I_{\text{absorbed}} \quad (1)$$

This assumption will hold true to a very good approximation in an aircraft cabin, if the dominating noise source is the Turbulent Boundary Layer (TBL) excitation of the fuselage. The TBL excitation can be modelled quite well as a dense distribution of incoherent point forces acting across the exterior surface of the aircraft. If we assume further that the absorption of sound energy from the incident field can be described to a good approximation by a position dependent absorption coefficient,  $\alpha$ :

$$I_{\text{absorbed}}(\mathbf{r}) = \alpha(\mathbf{r})I_{\text{incident}}(\mathbf{r}), \quad (2)$$

then the absorbed intensity can be obtained from

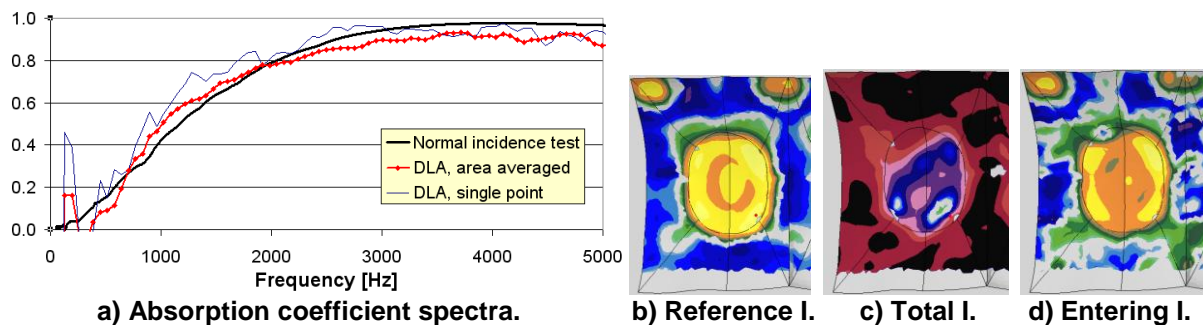
- 1) an extraction of the incident field component and thus the incident intensity on the panel surface from an array measurement of the total operational (in-flight) sound field, and
- 2) a separate passive (non-operational) array measurement of the surface absorption coefficient,  $\alpha(\mathbf{r})$ , using equation (2) with loudspeakers providing an artificial incident field.

For the operational measurement, the total intensity is also calculated on the panel surfaces. Once the total and the absorbed intensities are known on the surface, the entering intensity can be obtained from equation (1). In practice, the absorption coefficient  $\alpha$  that satisfies equation (2) will depend on the form of the incident field, in particular if the panel/source surface is far from locally reacting. If, however, the form of the incident field remains similar between the measurement of absorption coefficient and the operational measurement, then equation (2) will probably hold quite well with the same value of  $\alpha$  for both incident fields.

A more detailed description of the method is given in references [1] and [2], including an alternative method that uses surface admittance instead of absorption coefficient to characterize the scattering of the incident field. The measurements are performed in any case with an 8x8x2 Dual Layer Array (DLA) with 3cm pitch (Figure 1c), and the array calculations, including the separation of the incident field component from the measured total field, are performed using Statistically Optimized NAH (SONAH), which is described in more detail in reference [3]. The prototype implementation is based on Brüel & Kjær’s Conformal Mapping system.

Figure 1a shows a set-up with a fuselage section in Dassault’s Transmission Loss (TL) facility. Incident fields for both the operational and the non-operational measurements were provided by 5 B&K omni-directional loudspeakers (black “cigars” in the picture). The entering (radiated) field was created by a set of “TL loudspeakers” in the transmission room of the TL facility. The use of the 5 B&K loudspeakers in the shown geometrical configuration for the measurement of the absorption coefficient was motivated by numerical simulations described in reference [1].

For the measurement of the absorption coefficient, the TL loudspeakers were off while the 5 B&K loudspeakers were excited by incoherent broadband noise of equal level. Figure 2a shows a comparison of the absorption coefficient spectrum of the homogeneous trim panel surface (see Figure 1b) obtained from 1) the DLA measurement, and from 2) a normal incidence measurement on a test sample in a plane wave tube. The DLA result is given for a single calculation position and averaged over a small area. The agreement is good, keeping in mind that the tube measurement is for normal incidence only, while the DLA measurement has incident waves from many directions.



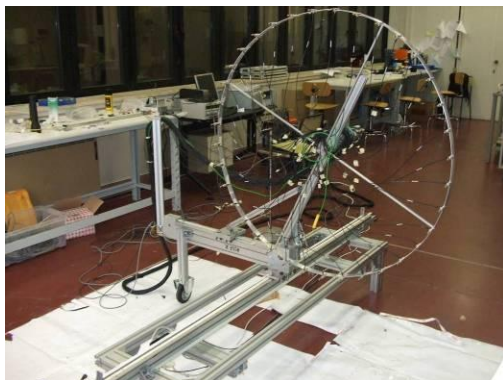
**Figure 2: Extraction of the Entering Intensity. Green-yellow contours: Outward intensity. Blue-red: inward intensity. Contour interval: 2 dB. All maps show data for a single octave band with the same threshold level.**

The measured map of absorption coefficient across the panel surface was then used to extract the Entering Intensity from a measurement where both the TL loudspeakers and the 5 B&K loudspeakers were active. Figure 2b shows the sound intensity map on the panel measured with the DLA system when only the TL speakers are operating – this is the reference intensity to be extracted from the measurement with incident background noise. Figure 2c shows the total sound intensity on the panel when both sets of loudspeakers are operating, i.e. with background noise. Clearly, the power absorbed from the incident background noise is much stronger than the entering reference power, so the total intensity is dominantly negative (inward). Figure 2c shows the extracted entering intensity, which is very similar to the reference intensity map.

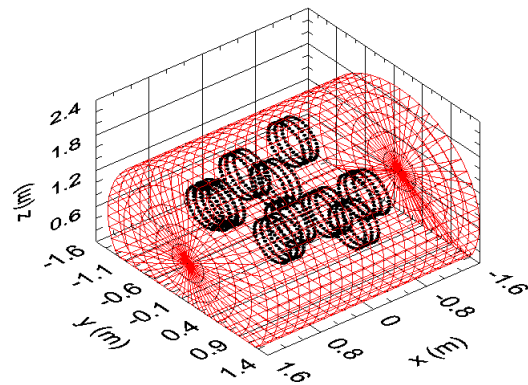
Better results were in general obtained with the described method based on absorption coefficient than with the method based on measurement of surface admittance. The surface admittance method avoids the assumptions related to equations (1) and (2), but assumes instead a perfectly locally reacting panel surface.

## 2.2 Local reverberant field measurement and processing algorithms applicable at high frequencies: 3D Beamforming for trouble shooting and quality control

At higher frequencies, where the acoustic absorption in the cabin is greater, complementary methods based on 3D beam-forming technologies have been developed by UNIVPM. Although these methods were well established in non-reverberant environments, their applicability in reverberant sound fields has been investigated and some improvements of the basic algorithm have been studied with the aim to make the beamforming technique efficient also in this challenging situation. The developed 3D beamforming system is based on an array of 36 microphones that is moved in the measurement environment in several positions in order to improve the quality of measured data, see Figure 3. This strategy allows to reduce significantly the cost of the system, requiring a limited number of microphones. Since the acquisition should be performed in simultaneous sampling of all microphones signals, in order to respect phase relationships between measured acoustic pressures, a fixed microphone is used as phase reference.

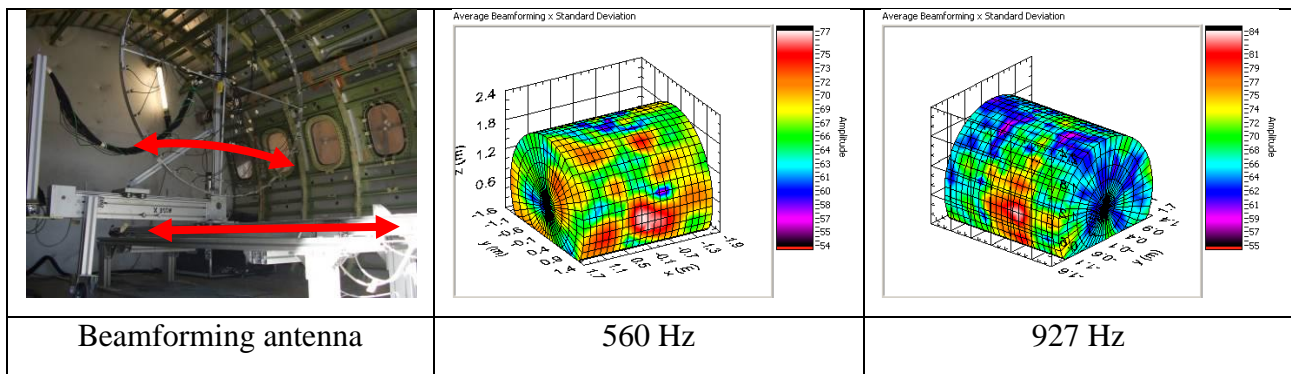


36 microphones array



Array positions (black) and location where the beamforming output is calculated, the so-called control points (red)

**Figure 3: Beamforming array and measurement positions**



**Figure 4: Average Beamforming x Standard Deviation**

A typical result of the 3D beamforming is shown hereafter. The technique has been applied for the measurement of the acoustic field inside a fuselage section mock-up, the Alenia ATR42. The following figures show the Beamforming measurements and results. The beamforming output is



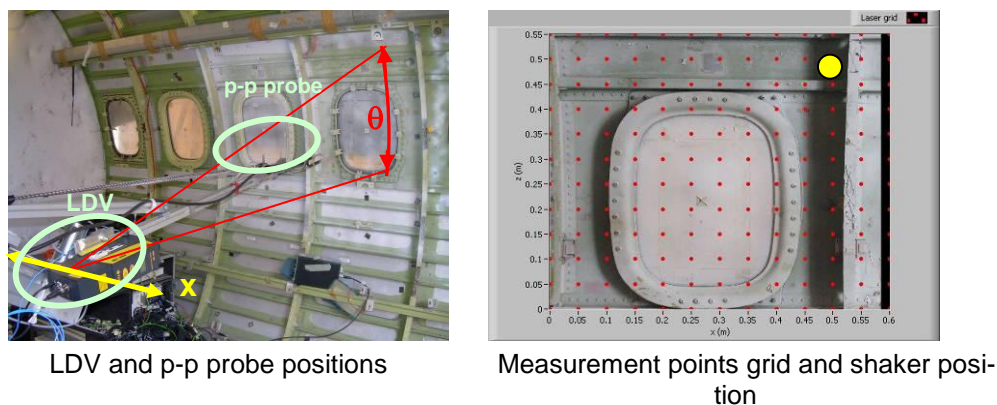
the acoustic power (dBW) calculated on the control points positioned on the internal surface of the mock-up.

### 2.3 Coupling of scanning laser Doppler vibrometry with reverberant acoustic field local measurements

Scanning laser Doppler vibrometry (LDV), measuring the vibration of surfaces in the cabin, has been used by UNIVPM in parallel with acoustic intensity measurements and exploited as reference for coherent intensity calculation. Each scanned point is considered as a source, so as to achieve 2-D high-resolution maps of coherent intensity. The implementation of LDV in flight tests – in which conventional mountings would vibrate as much or more than the panels being measured – represents a considerable step forward in the implementation of this technology.

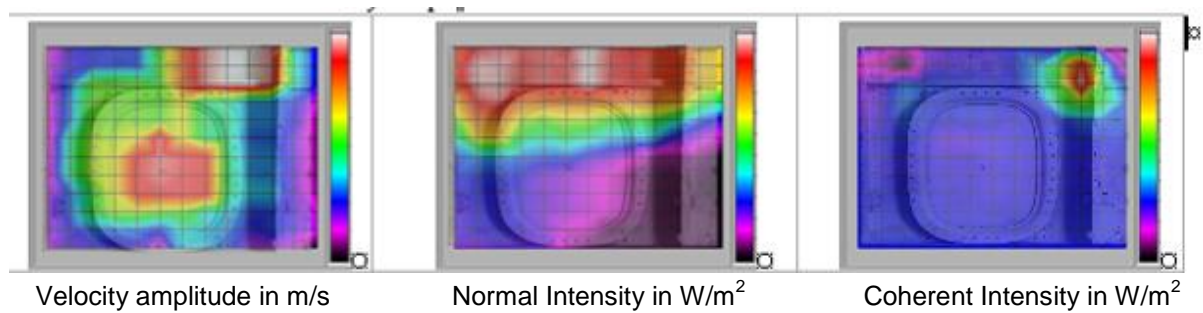
The coherent intensity method is based on the modelling of a multiple sources system (as it can be the reverberant environment inside an aircraft cabin), measured by means of an acoustic intensity probe, as a linear, multiple input-two output problem (since the outputs are the acoustic pressures measured by the two microphones of the probe). Solving this problem in a least-squares sense the component of the cross-spectral density between the output and each input source can be calculated. This component is the one that the microphones (outputs) would “hear” if only the corresponding source (input) would be switched on and radiating the acoustic field, not considering the complexity of the whole sound field produced by all the sources emitting simultaneously. This allows to quantify and localize the “critical” sources [4].

In the following, the application of the laser-based coherent intensity method for the acoustic field measurement inside the Alenia ATR42 aircraft cabin mock-up is shown [5]. The LDV and p-p probe were mounted on the same arm of an automatic positioning system able to scan both longitudinal ( $x$ ) and angular ( $\theta$ ) positions, see Figure 5. The fuselage section mock-up was excited via a shaker fed with white noise in the range of 0-1000 Hz. The measurement points grid and the shaker position (yellow dot) are shown in Figure 5.



**Figure 5: Test set-up**

The measurement results, i.e. surface vibration velocity of the cabin portion measured by LDV, normal intensity measured by the p-p probe and coherent intensity calculated by correlating the normal intensity and the vibration velocity, are reported in Figure 6. The shaker position is well localised only in the coherent intensity map.



**Figure 6: Vibration velocity, normal intensity and coherent intensity distribution maps**

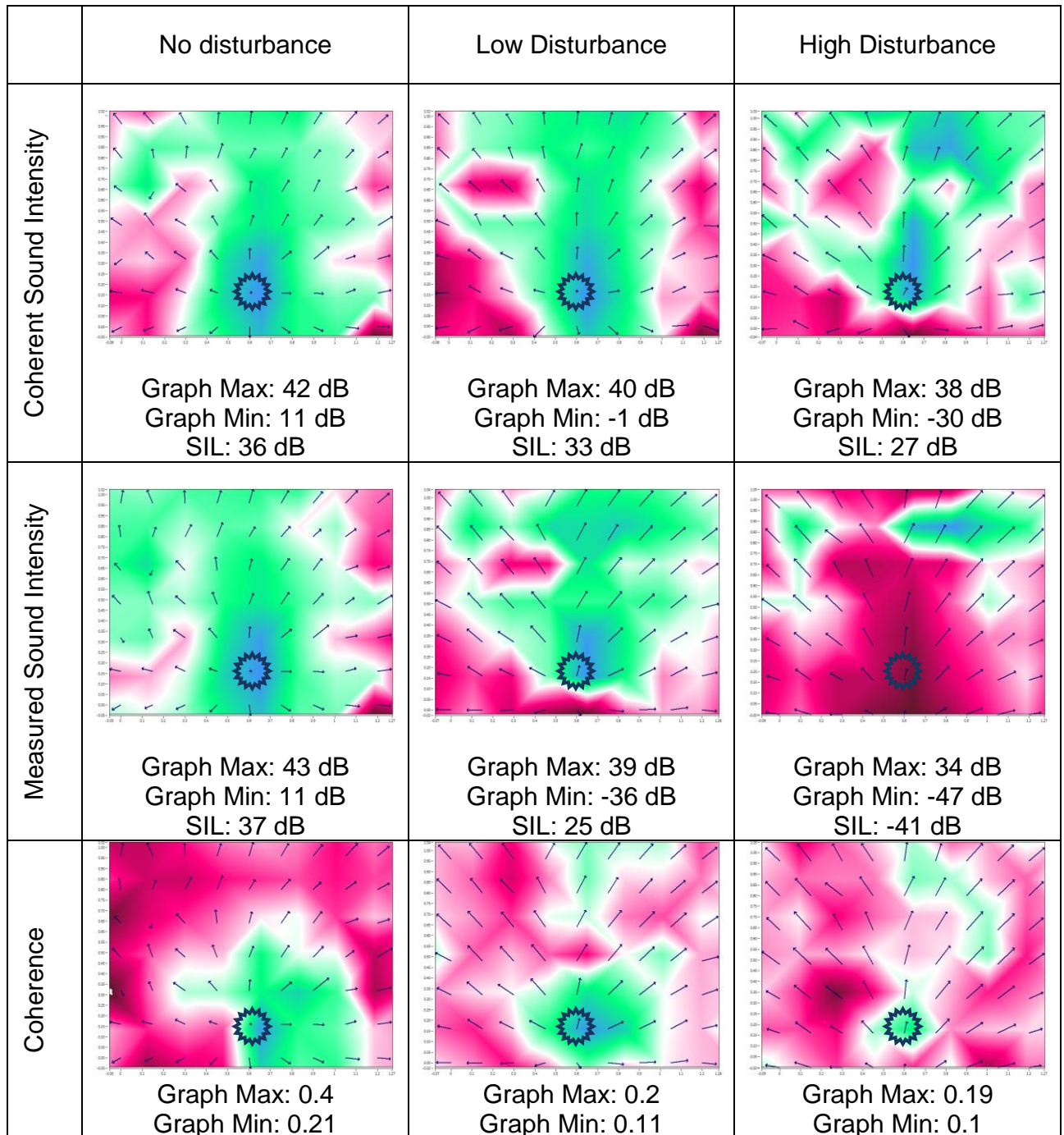
An alternative method for the identification of the correlation between the vibration of a panel (namely a part of an aircraft cabin) and the sound field parameters (pressure, velocity and intensity) measured at the vicinity has been developed by Politecnico di Milano. The method, applicable in reverberant environments, is based on the ordinary coherence function, that describes how two signals are linearly related. Coherence is computed between two signals that are an input and an output of a generic system: in our case, the input is the vibration of the panel and the output is the sound intensity vector. Coherence, due to its mathematical definition, can assume any value in the range between zero and one: low coherence values can derive from uncorrelated noise in input or output measurement, non-linear behaviour of the system, non-measured signals input into the system or leakage errors. In the specific case of aircraft cabins, if the sound field close to the panel only depends on the measured vibration, coherence is close to one. If one of the previously mentioned conditions occurs, then coherence will decrease. Coherence maps can consequently provide for useful information in the identification of hot spots on the panel that are responsible of the noise inside the cabin.

The method validity was experimentally verified on an elastically suspended aluminium plate. Vibration was imposed to the plate by a piezoelectric shaker. Coherence was computed between the vibration measured by an accelerometer placed on the plate and the 3D sound intensity vector in presence of disturbances (sound emitted by loudspeakers located close to the plate). The coherence maps were used to identify the position of the shaker.

In the next plots, arrows symbolize the direction of the acoustic energy flow close to the plate. The color symbolize the magnitude of the sound intensity component perpendicular to the plate or coherence value. The maps show that the coherence can help identifying the position of the shaker, as clearly shown in the third row, since largest coherence values (green color) are always obtained in correspondence of the excitation point.

A parallel output of the method is the coherent intensity, that is obtained by multiplying the coherence by sound intensity. It can be noted that coherent intensity is less sensitive to disturbances with respect to the raw sound intensity.

Many other experiments and simulation were performed, and results showed that the coherent intensity method allows pointing out the dependency between the panel vibration and different parameters of the acoustic field. The method was found to be effective when the impedance of the surface was large; limitations arose in presence of coherent disturbances and of large vibro-acoustic interactions.



**Figure 7: Coherent intensity as a function of the level of disturbance. Sound Intensity in the frequency range of 1000-2000 Hz. Stimulus and disturbances: uncorrelated Gaussian white noise. The symbol identifies the geometric position of the piezoelectric shaker.**

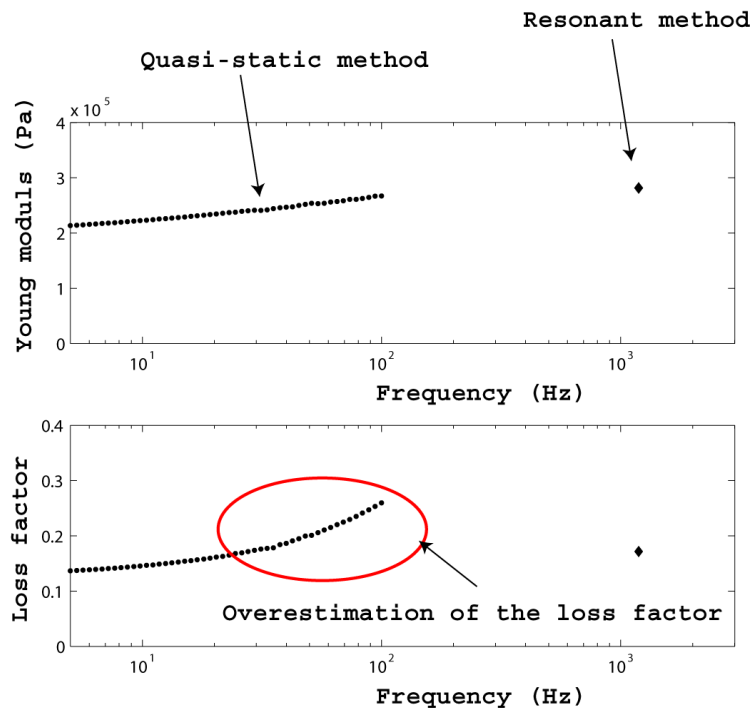
## 2.4 Inverse methods for test-based model identification for fibrous materials

Porous materials are widely employed for acoustical comfort design in aircraft.

Often attached to vibrating structures, porous layers provide: (i) structural damping due to a mechanical coupling between the vibrating structure and the frame; (ii) sound absorption, sound radiation and transmission reduction due to an acoustical coupling between the frame motion and the saturating fluid motion. Their efficiency can thus be greatly influenced by the elastic and damping properties of the frame. To take into account the porous behavior by the Biot-Allard theory, the dynamic elastic constants "in vacuum" of the material have to be known.

Classical methods to measure the viscoelastic properties of the frame can be sorted in two groups:

- the quasi-static methods neglect the inertia effects and give relevant information in the low frequency range before the first resonance of the system (usually for  $f < 100$  Hz). A result carried out from the compression of an elastic foam sample is shown in Figure 8 (black points).
- the dynamic methods are based on the vibration study of a porous layer, or of a structure which includes a porous layer, and give information at the resonance frequencies of the structure. A result is given from an inverse method based on the measurement of the radiation efficiency of a circular plate covered with the same foam layer (black diamond).



**Figure 8: Viscoelastic properties (Young's modulus  $E_L$  and loss factor  $\eta_L$ ) of polymer foam determined by quasistatic method (circle) and by inversion method from radiation efficiency of a covered circular plate.**

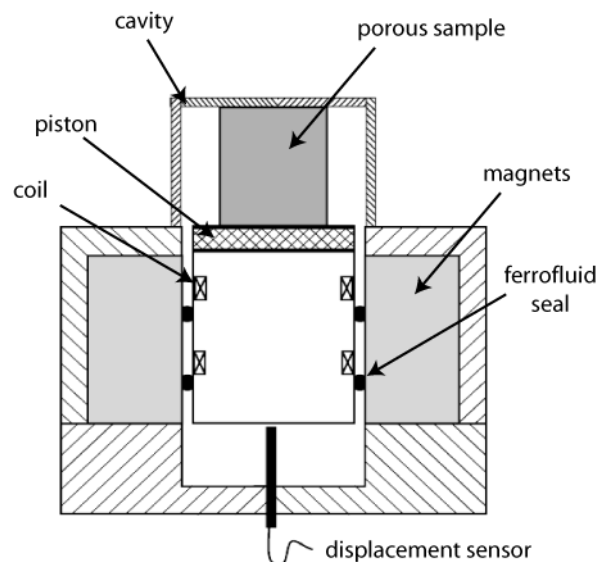
Most of the existing methods are carried out in ambient conditions because "in vacuum" conditions lead to some experimental problems: the experimental setup is heavier, the frame of some types of acoustical material can be destroyed, the properties of the frame can change because of



the temperature decrease. Usually, the methods carried out in ambient conditions neglect the effects of the coupling between the frame and the surrounding fluid and the material is considered "in vacuum". However, it has been shown that the presence of air can lead to an overestimation of the estimation of the frame loss factor. This is shown in Fig.1 where the loss factor estimation determined with the quasi-static method seems greatly overestimated.

In this work, LAUM proposed a method to extend the quasi-static measurement set-up based on the compression of a porous sample towards medium frequencies [6], [7].

This method presented in Figure 9 avoids the effect of the surrounding fluid and extends the frequency range of measurement : (i) the porous sample is placed in a cavity in order to avoid a lateral airflow, (ii) a specific electrodynamic transducer has been developed to get the mechanical impedance of the fibrous sample from the measurement of the electrical impedance in the low and medium frequency range, (iii) mechanical properties of the frame are derived by inverse method using the Biot's model. Experimental results obtained with a polymer foam show the validity of the method for an extended frequency range from 100 Hz to 500 Hz, [7].



**Figure 9: Measurement set-up**

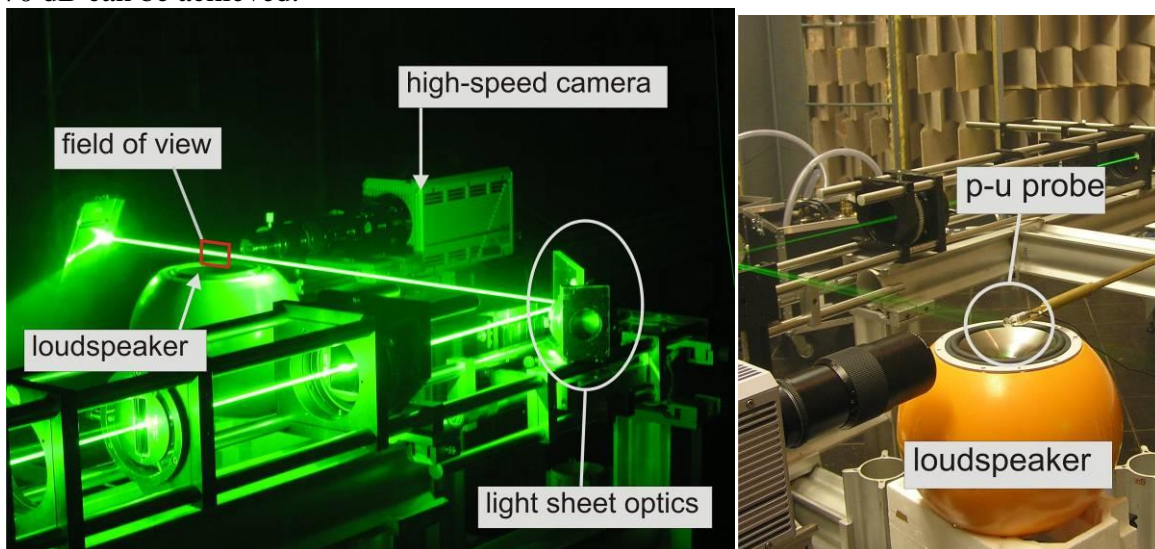
## 2.5 Evaluation of the p-u probe technology for local cabin measurements

Traditional intensity measurement technique sometimes fails because the high pressure/intensity indices of the diffuse fields require extremely well phase-matched microphones [8]. For that reason a new probe will be used to determine the radiated sound intensity. This probe measures the sound velocity directly across two tiny, resistive strips of platinum wires. In combination with a small microphone this probe is called a p-u probe to indicate the two physical values, velocity (u) and pressure (p). The acoustic velocity changes the temperature distribution of both wires and due to the operation principle based on the asymmetry of the temperature profile the probe can distinguish between positive and negative velocity directions. Therefore, the p-u sensor is a promising tool to investigate the radiated sound power inside an aircraft cabin, but, since now, it has been applied, in this context, only in preliminary tests. Consequently the feasibility of sound intensity measurements under real flight conditions have been explored by DLR.



In a first step of the present investigations the probe has been calibrated with a new technique. The amplitude and phase calibration of the p-u probe is a crucial problem in the practical application of the probe. Especially in reactive sound fields like an aircraft cabin the accurate phase calibration in the lower frequency range is a requirement for a correct sound-intensity result. The general problem of the p-u probe calibration is that the probe consists of two completely different transducers, the velocity and the pressure transducer, with different amplitude and phase responses. In practical applications the velocity transducer is usually calibrated with respect to the pressure transducer of the p-u probe. The p-u probe is exposed to a sound field with known specific acoustic impedance and by measuring the pressure fluctuations with a reference condenser microphone the amplitude and phase of the velocity transducer of the p-u probe can be calculated [9]. However, this procedure has its limits. The formulation of the acoustic impedance can be very complex if the plane wave propagation is not guaranteed.

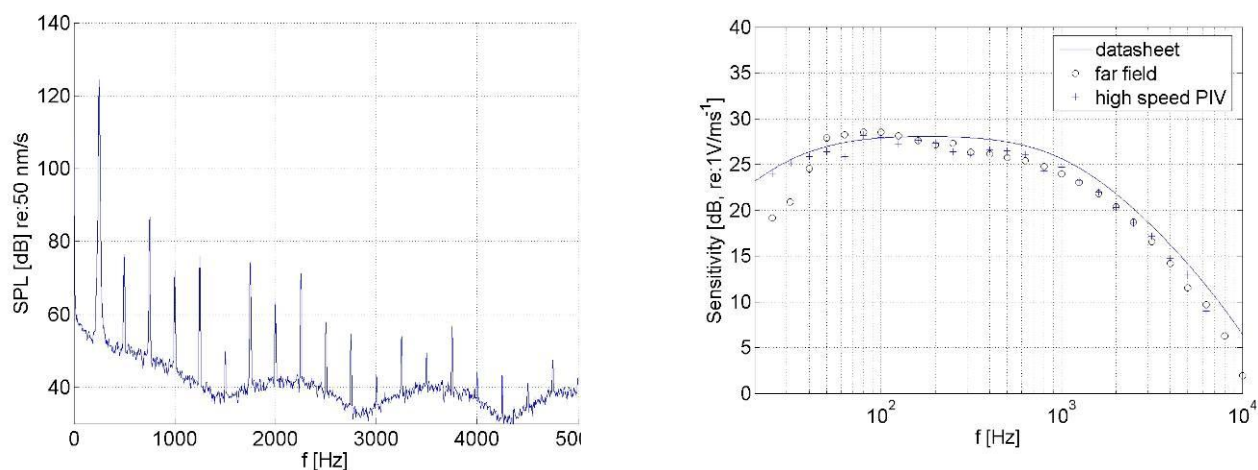
Therefore, a new technique has been developed to obtain absolute levels of the sound velocity by means of particle image velocimetry measurements. This is a non-intrusive flow measurement technique. Small tracer particles advected by the flow are illuminated twice by very short pulses of a laser light sheet defining the measurement plane. Digital optical sensors capture the light scattered by the particles. Employing image analysis techniques instantaneous velocity vector fields are obtained in high spatial resolution [10, 11, 12, 13]. Figure 10 shows the measurement setup of the high speed PIV measurement used in this investigation. The two-way loudspeaker is excited with a sinusoidal signal. The laser light-sheet illuminates the near field region of the loud speaker. The scattered light from the tracer particles is captured by the high-speed camera system. With this state-of-the-art high speed PIV system the sound field can be sampled up to a frequency of 20 kHz [14, 15]. Figure 11 (left) shows the spectral representation of the measured sound velocity fluctuations at 250 Hz. The spectrum shows that a high dynamic range of about 70 dB can be achieved.



**Figure 10: Calibration measurement with a high-speed PIV system. The picture on the left shows the sound velocity measurement with the high-speed PIV system. The high-speed camera captures the scattered light from the velocity fluctuations in the near field of the loudspeaker. The right hand-side picture shows the p-u probe measuring the sound velocity in the same near-field region.**

The results obtained with this new technique have been compared with measurements performed in a very large anechoic room. Figure 11 (right) compares the sensitivity results of the present high-speed PIV measurement with results obtained with the far-field measurement in the large anechoic room. In the frequency range between 80 Hz and 6.3 kHz both calibration meth-

ods show the same results. In the very low frequencies,  $f < 60$  Hz, the results obtained in the far-field measurement deviate by more than  $\Delta L = 5$  dB from the high-speed PIV measurement results. For this frequency range the free-field condition of the anechoic room can no longer be guaranteed. The comparison shows that it is possible to measure the particle velocity with a high-speed PIV system in a large frequency range. Even in the low frequency range,  $f < 50$  Hz, the high-speed PIV measurement technique shows a very high accuracy of the measured sound velocity values.



**Figure 11: Sound velocity fluctuations measured with the high-speed PIV system in the near-field of a loudspeaker. Left: Spectral representation of the measured sound velocity at 250 Hz. Right: Comparison between high-speed PIV and far-field measurement in a large anechoic room. Displayed is the sensitivity [ $\text{V}/\text{ms}^{-1}$ ] of a p-u probe measured with the high-speed PIV system (+) and with the far-field procedure in a large anechoic room (o). The blue line shows the calibration curve given by the manufacturer.**

The high-speed PIV system is, as these results show, a very powerful tool to measure reliably the particle velocity in a large frequency range and therefore provides the possibility of calibrating velocity sensors independently of the surrounding sound field. The advantages of this calibration technique compared to previous ones are:

- Absolute sound velocity levels can be obtained directly from the measured data.
- Higher accuracy of the amplitude calibration in the lower frequency range.
- Independency of the sound-field, no anechoic room is required.

### 3 WP 3 Global measurement and processing procedure

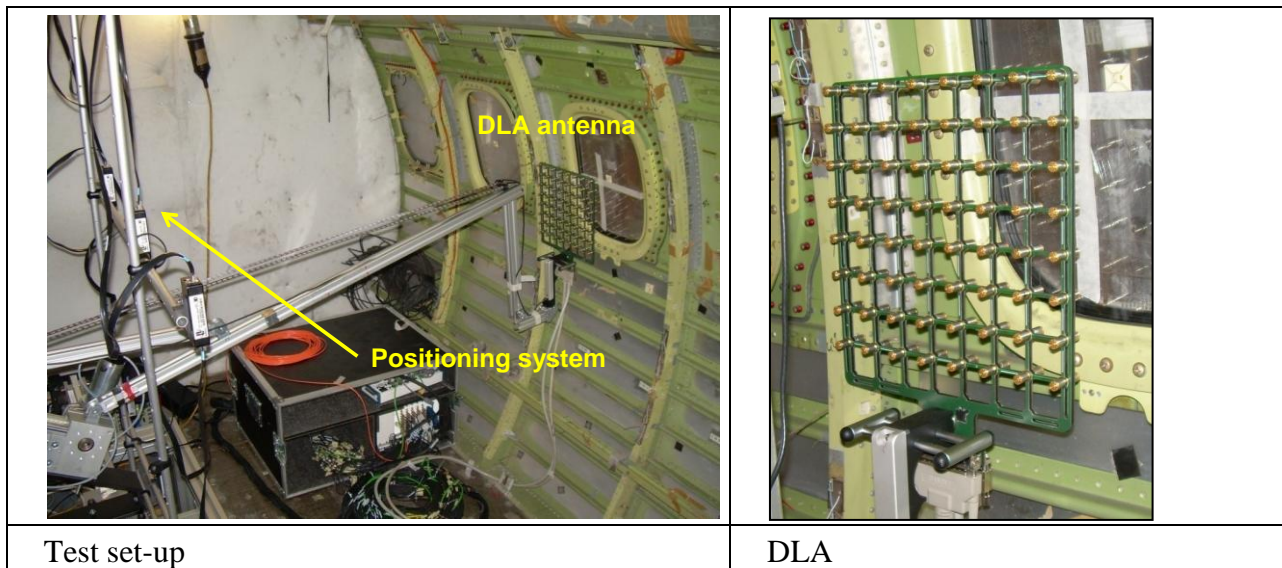
#### 3.1 Global models and experimental procedures for aircraft cabin in the low-medium frequency range

In the low-medium frequency range the disturbance is basically tonal, as for turbo-propeller aircrafts. In the CREDO project the ATR 42-500 example will be considered. In this case, the relevant noise disturbance is related to the propeller rotation frequency which, at cruise conditions, is around 100 Hz.

The aircraft has been subjected to several treatments to reduce the noise levels inside the cabin as the installation on the frontal section frames of Dynamic Vibration Absorbers (DVA's) opportunely tuned. So far, such tools have been positioned inside the fuselage on the basis of dynamic analysis while now the new developed techniques and the innovative numerical models will be used for the optimisation of the DVA positioning, having as objective function the radiated sound power.

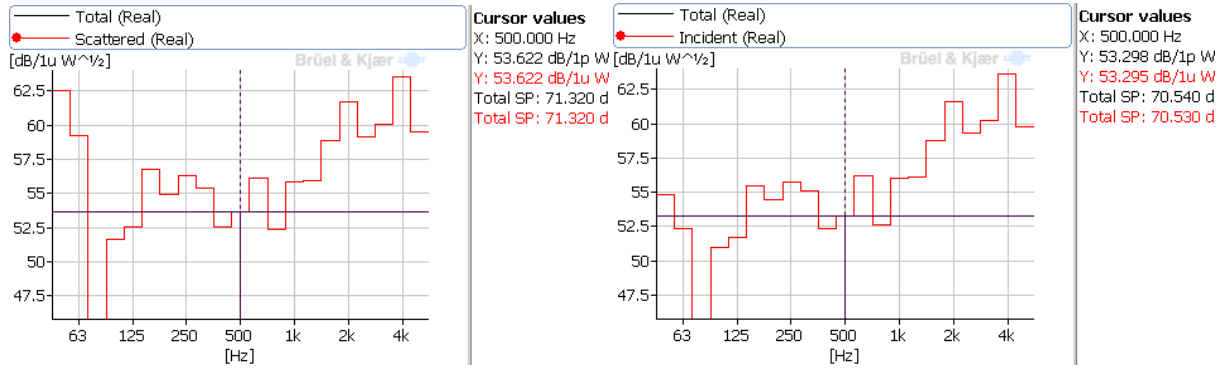
The ATR mock-up has been used as test bench for the application and validation of the innovative experimental techniques developed in WP2 of the CREDO project. In practise the following measurement systems have been applied: - LDV, - Coherent Intensity Method, - Beamforming, - DLA and SONAH, - p-u probe.

As an example, the results of the DLA measurements, carried out by Bruel and Kjaer, are shown here. The antenna (Double Layer Array) was made of two layers of 8x8 TEDS microphones with a 0.03 m spacing and was moved in 6 positions slightly overlapping: 2 along the x-direction and 3 along the z-direction in order to scan an area covering one window.



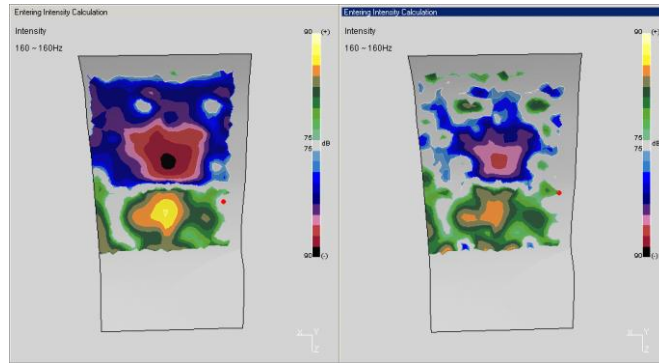
**Figure 12: DLA installation**

The absorption measurement inside the cabin showed that above 250 Hz, the overall incident and scattered intensity were almost the same, see Figure 13. Therefore the absorption is very small and the entering intensity not very meaningful, since in this case the entering intensity is very close to the measured total measured intensity.



**Figure 13: Scattered and Incident intensity 1/3 octave spectra**

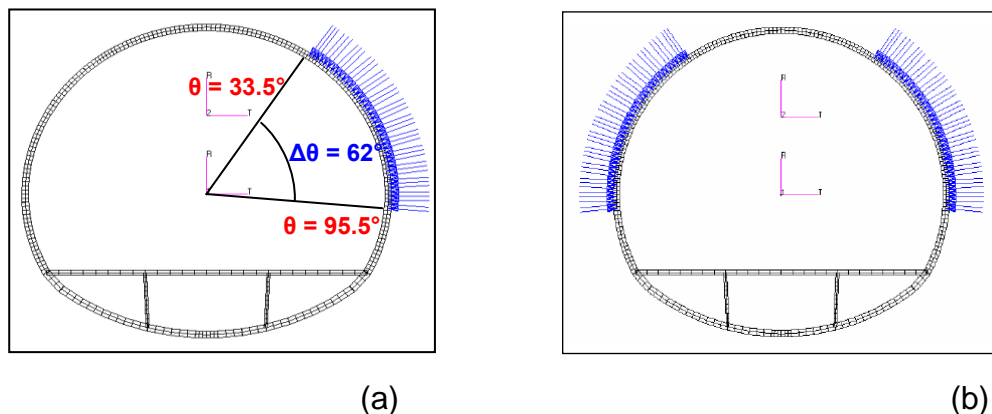
The total and entering intensity measured with the excitation given by the external loudspeakers at the frequency of 160 Hz is given in Figure 14. The main contribution from the window is evident.



**Figure14: Total and entering intensity (left and right plot respectively) at 160 Hz (1/3 octave).**

UniNapoli has integrated the new measurements techniques with numerical methods for FE model calibration taking advantage of higher quality of the available experimental data.

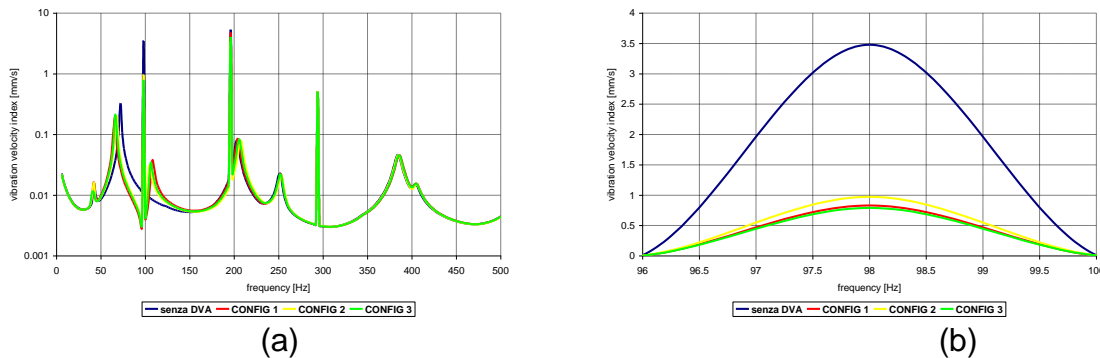
These activities started developing a 2-D FE model of a typical ATR frame introduced to perform first approximation studies of ATR’s mock-up dynamic behaviour. In the frequency range of interest (ATR Blade Passing Frequency and its first harmonics), in fact, the stiffened cylinder dynamic behaviour is mainly related to frames motion. The skin panels act like masses attached to the frames and in first approximation it’s possible to study a single frame to analyze global phenomena. Frequency response analyses of the frame without any device and with DVAs installed under symmetric as well as asymmetric dynamic load conditions (Figure 15) have been performed in the frequency range 0-500 Hz.



**Figure 15: Asymmetric (a) and symmetric (b) load distribution in circumferential direction**



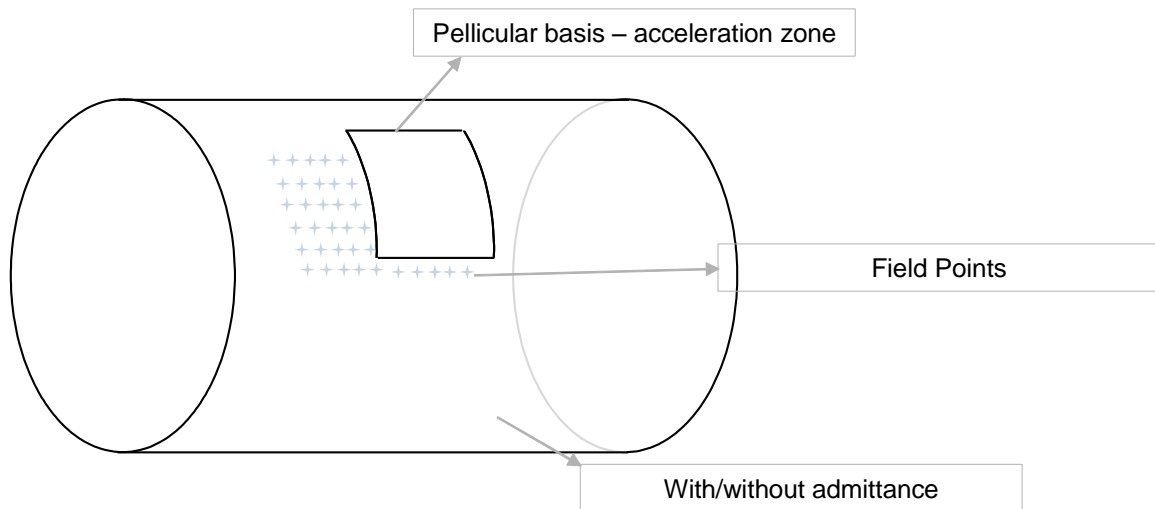
Results achieved for the symmetric load case with DVA tuned at 98 Hz are presented in Figure 16.



**Figure 16: Results in terms of vibration velocity index for symmetric load and DVA tuned at 98 Hz (blue: without DVA, yellow, red, green: DVA in different configurations)**

At the moment, an inverse procedure is under development, whose aim is to determine the DVAs position starting from acoustic data.

FFT has developed an alternative inverse approach based on acoustic finite element method and on the use of acoustic eigenmodes of a thin air volume surrounding the radiating surface, or pellicular acoustic modes. Normal vibration velocity and surface acoustic pressure may be expressed as linear combinations of these pellicular modes, where the unknowns of the inverse problem are the complex amplitudes of each mode. This choice of unknowns is likely to stabilize the inverse procedure and dramatically reduces the size of the inverse problems. The choice of a finite element method has the following benefits over a boundary element approach: ability to include the effect of volume absorbers like seats, possibility to model non locally reacting liners and reduced CPU time.

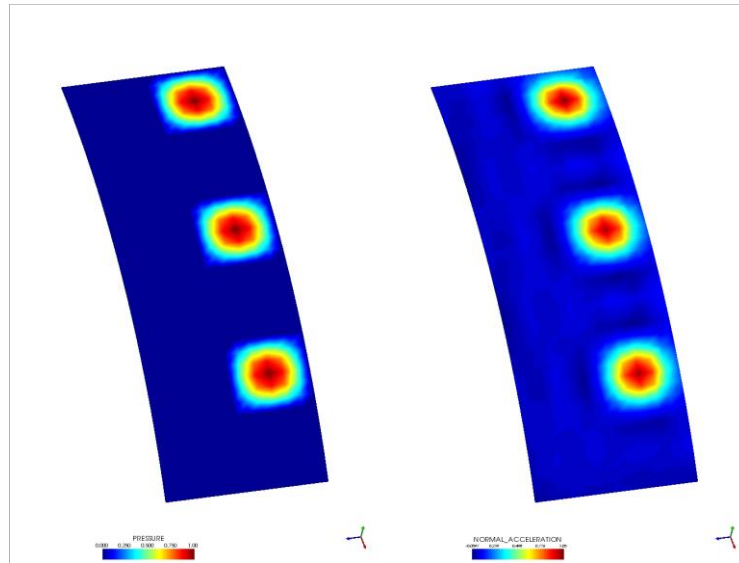


**Figure 17: Unknown velocities on a subset of the cylindrical structure will be reconstructed based on the pressure signal at a number of field points.**

A first fully-functional release of the inverse model is ready and it has been used to reconstruct the most likely velocity field on a vibrating panel using acoustic signals at a number of microphones. The final aim is to integrate the results of the new array-based measurement techniques



that will be used as input for the inverse model. The following picture document the initial benchmark problem used.



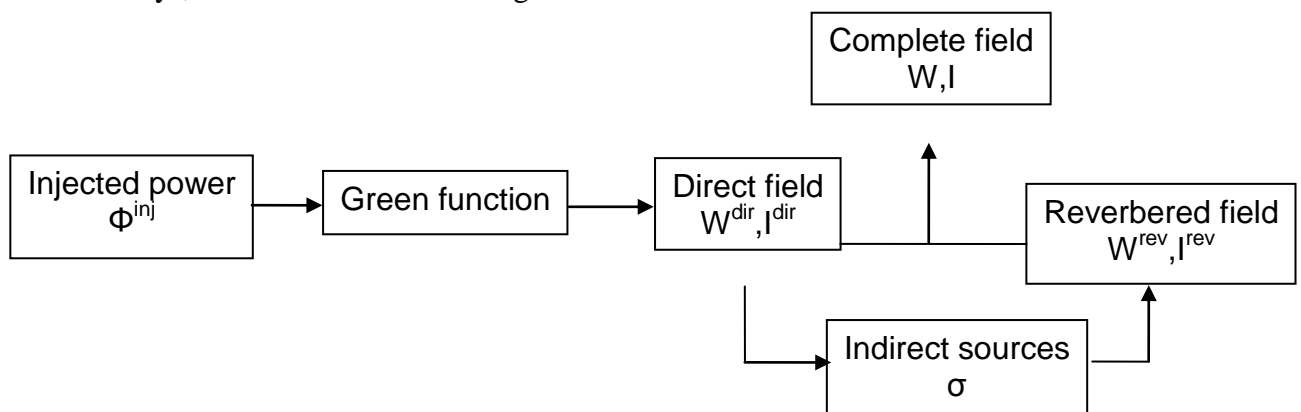
**Figure 18: The actual and reconstructed velocity profile on panel is compared above. The inverse algorithm is functioning correctly**

### 3.2 Global models and experimental procedures for aircraft cabin in the medium-high frequency range

The definition of global procedures for noise sources identification in the medium-high frequency range (the Speech Interference Level or SIL domain : 700-5700 Hz) has been done by DASSAULT in collaboration with ECL. The procedure identified is hybrid since it is based on a FEM, modelling of the direct field, and a classical MES (Simplified Energetic Method), modelling of the reverberated field.

The aim of Hybrid MES (HMES) is to take into account the direct field that is not precise enough in “classical” MES. By using a FEM/MES hybrid method, the “real” direct field can be modelled.

By the “classical” MES method the different fields (direct and reverberated) are calculated in different ways, as shown in the following scheme.

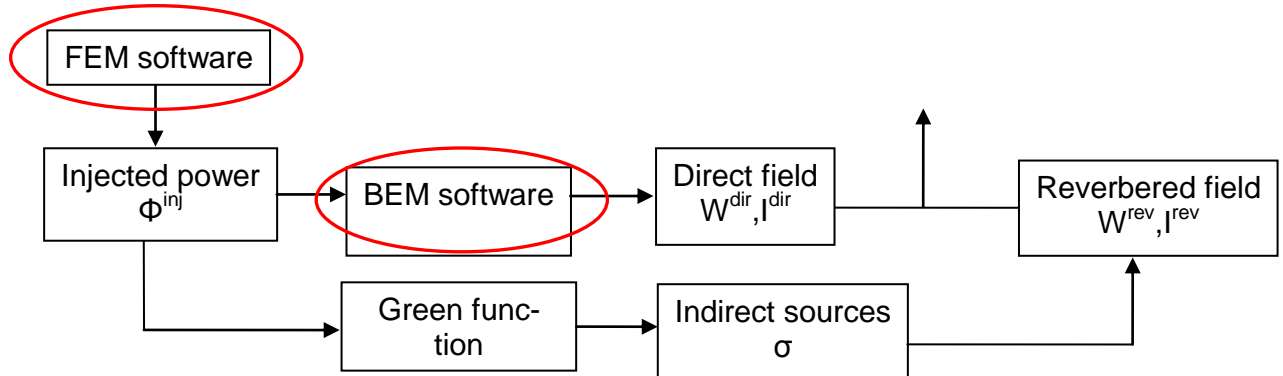


Concerning the “classical” MES method, the main hypothesis can be expressed as follows:

- decomposition of the field in two parts: direct and reverberated field,

- interferences not taken into account,
- directivity of the power source assumed to be known.

These two last points are not anymore necessary with HMES, as shown in the following drawing.



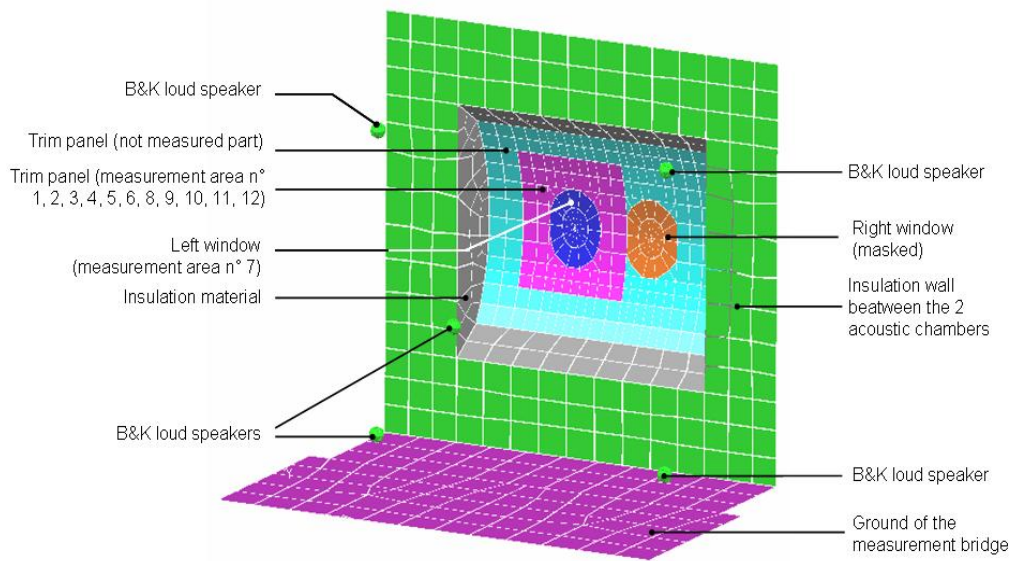
The HMES needs a FEM software for the calculation of the injected power and a BEM software for the calculation of the direct field. The FE model was made in COMSOL and the BEM calculations were made with Matlab. Notice that the inverse hybrid method will not need any FEM software.

This method has been applied to the evaluation of the acoustic emission of a fuselage-like panel fixed between a reverberant and an anechoic room, in the DASSAULT premises. A diffuse field is created in the reverberant room in order to excite the panel. The radiation of the panel is measured in the anechoic room. Several acoustic environments have been created on the radiating side in order to disturb the anechoic properties of the room and check that the measurements methodologies are working in downgraded conditions.

The MES model used for post-processing the results includes all the elements of the experimental set-up, as described in the Figure 19.

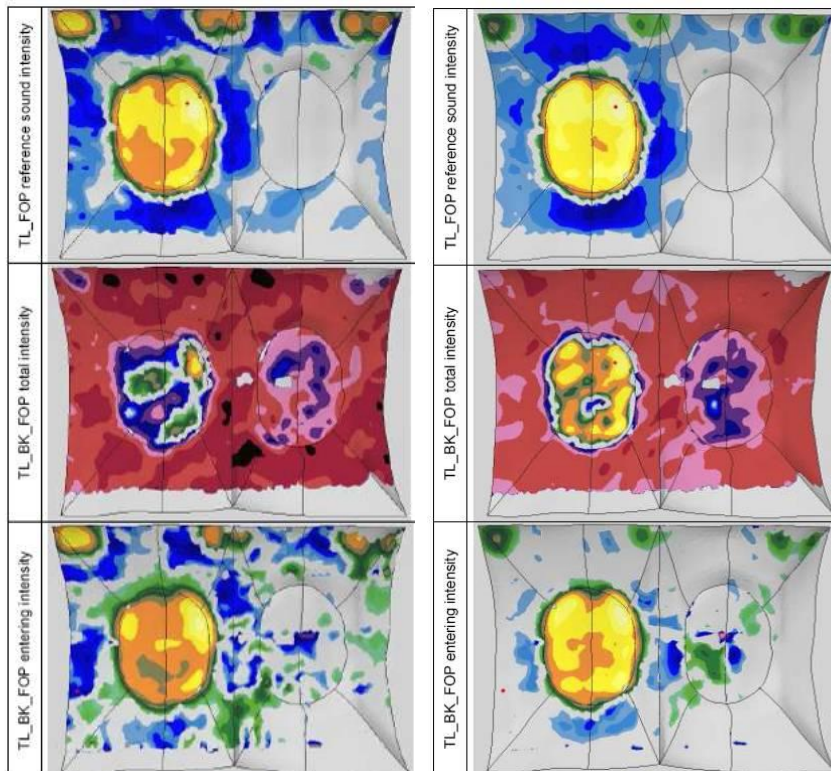
The 1235 facets of the models allow to represent the surfaces of :

- the tested panel itself (trim panel + window(s)) ;
- the insulation materials and the insulation wall between the 2 rooms ;
- the measurement bridge ;
- the reflectors (in the configurations where they are needed) ;
- the BK loudspeakers.



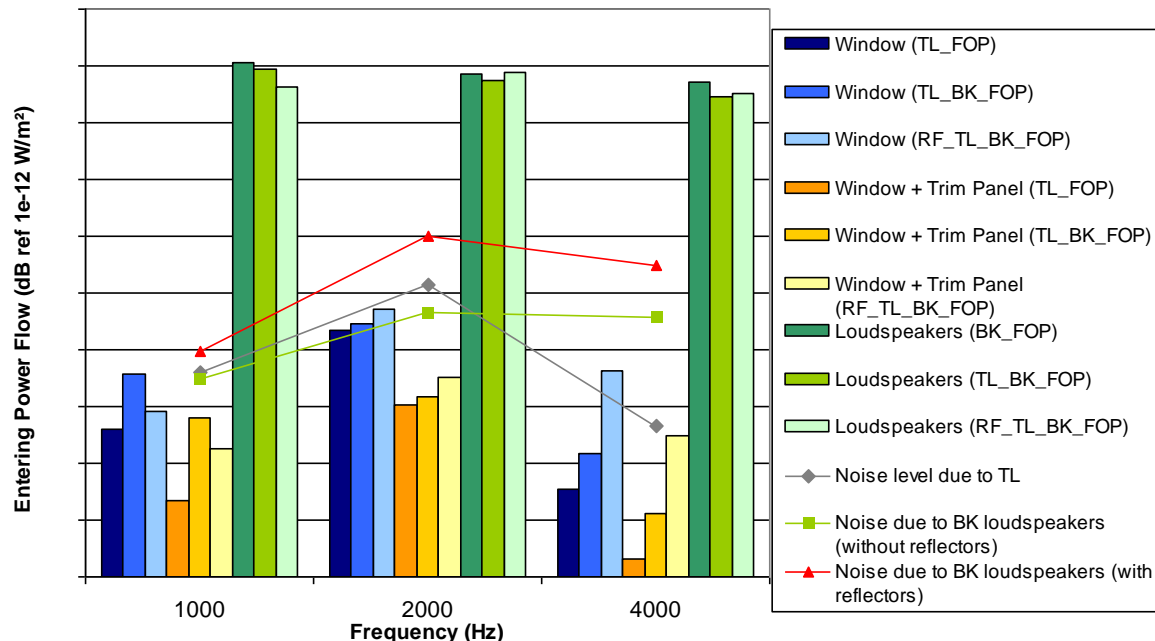
**Figure 19: MES model of the experimental set-up (without the reflectors and the anechoic facets)**

Figure 20 illustrates the results of the measurement performed at Dassault with the DLA: the extraction of the Entering Intensity from the Total Intensity measured with the BK background noise present. Each figure shows at the top the reference Entering Intensity measured under free-field conditions (TL\_FOP), in the middle the Total Intensity when the BK source is also active (TL\_BK\_FOP) and at the bottom the Entering Intensity extracted from that measurement. The surface absorption coefficient was calculated based on the BK\_FOP measurement, i.e. with no reflecting walls.



**Figure 20: Entering intensity in the 1kHz octave band (left) and 2kHz octave band (right)**

The analysis of the results aimed at showing in which conditions the inverse MES worked. The references power flow were first estimated in the reference configurations (anechoic conditions), and then in disturbed configurations.



**Figure 21: Comparison of entering power flows identified with the measurements of the configuration TL\_FOP & BK\_FOP (reference cases) and the measurements of the configuration TL\_BK\_FOP and RF\_TL\_BK\_FOP**

Figure 21 shows a strong sensitivity of the results to the background noise created by the loudspeakers. The accuracy of the entering power flow identified for the window and the trim panel (TL noise) quickly decreases when the average noise level due to the speakers is higher by 10 dB than the TL noise to identify.

We can point out several conclusions from the application of inverse MES:

- In all cases the calculated total intensities fit well the measured intensities;
- In the configuration we have analysed, the entering power flows are correctly identified if the background noise is not more than 10 dB higher than the source to identify. A power flow is identified with a very good accuracy when the associated intensity clearly emerges from the others.
- The error due to a bad model of directivity has been quantified. This has shown the interest of a MES model with experimental input, or at least realistic inputs for directivity.
- The errors due to the main experimental uncertainties (absorption, distance probe panel) have been quantified;
- The optimisation under constraints give more realistic results than the least mean squares approach; a way to calculate the optimum tolerance on measurements has been shown.

### 3.3 Global approach for acoustic power flow analysis in helicopters

In the very complicate structure of helicopters, the derivation of the exact propagation paths is hardly to be determined. The main gear box is mounted on the primary structure represented by a flat metal structure. The gearbox is connected to the cabin by gear struts. The interior panelling is represented by sandwich panels that are softly mounted on the primary structure. Classical methods, like Transfer Path Analysis or Panel Contribution methods, are not easy to be performed and not accurate.

Given this situation, global inverse procedures in combination with the DLA-NAH techniques have been used as comprising technique for determining the nature of sound propagation into the cabin in a very fast and effective way. In practice, the developed tools have been adapted to the helicopter case, for which the suitability of the proposed methods (e.g. effectiveness of inversion problem) has been verified and optimised by numerical simulation. They have been applied in mock-up and real helicopter cabins, as the BO 108 Mock-up (see Figure 22).

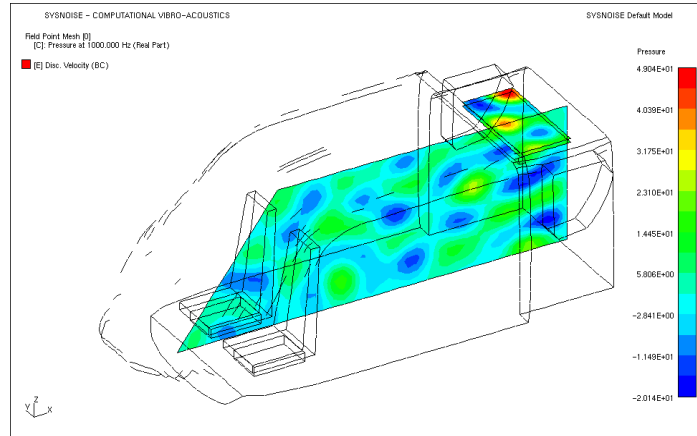
EADS-IW performed a serial of elementary theoretical validations in order to replace “physical test” results by “numerical test” ones, and to verify that the identification algorithm finds again the data given to the “numerical test” model. Specifically, it has been intended to generate numerical signal data in order to check for the peculiarities of the DLA-NAH technique and to test if the acoustical problem is suitable for inverse techniques especially in very small helicopter cabins. EADS-IW set up a generic BE-model for the helicopter cabin which represents a realistic environment for helicopters. There were two types of excitation investigated: (L) a leakage source, simulated by vibrating surface element, and (F/S) a sinusoidal mode shape of the gearbox panel. The second is separated into a slow and a fast wavenumber test case. The fast case is characterised by high radiation efficiency, whereas the low radiation efficiency of the slow case generates mainly evanescent waves. In Figure 23 one typical sound field due to leakage excitation can be seen.

In order to evaluate the influence of realistic perturbations on the DLA-NAH algorithm a set of errors was introduced. Possible errors were additional sources as shown in Figure 24 and phase and magnitude errors of the receiving microphones. The same figure shows the pressure field at the microphone array due these interior sources. The magnitude of the interior sources was chosen so that the pressure level of the interior sources has the same order of magnitude than the pressure due to the leakage or wave field, respectively.



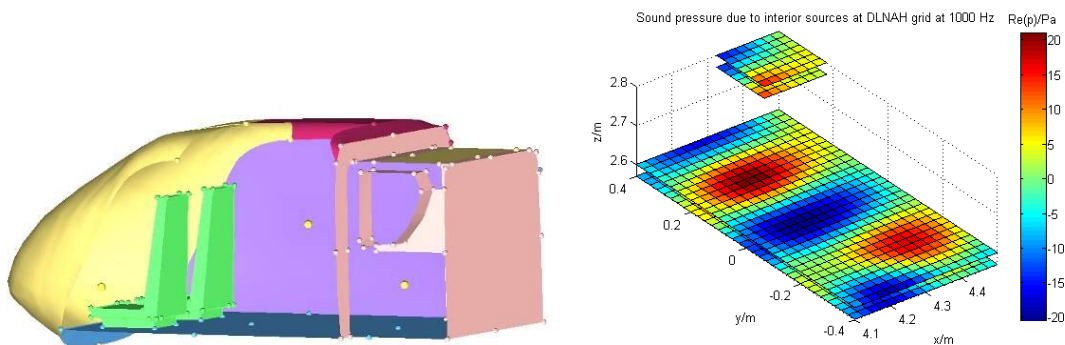
**Figure 22: BO 108 mock-up in reverberation room**



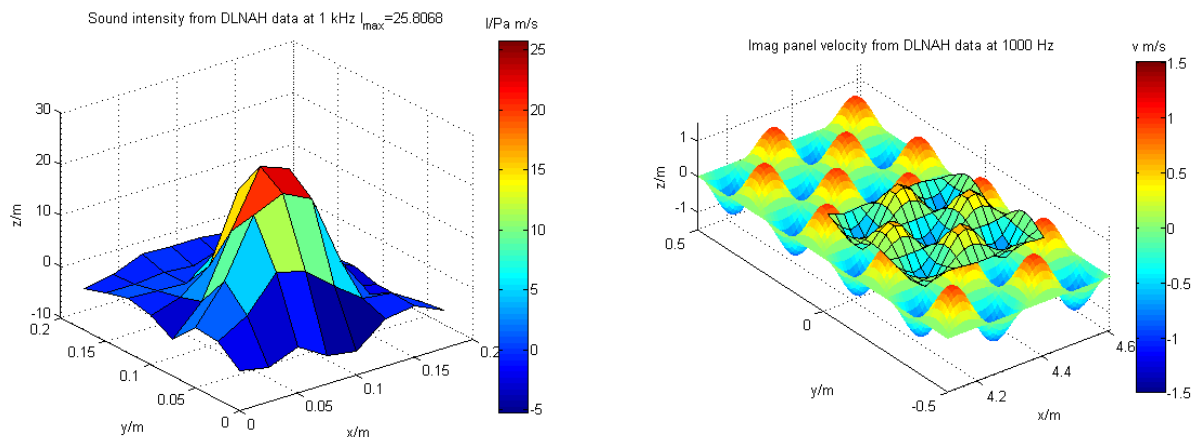


**Figure 23: Interior noise field in cabin due to point like excitation at gear panel area**

In all cases the algorithms was able to reconstruct either the correct intensity or velocity field. Even in the case of interior sources and high phase and magnitude error. Thus, from the theoretical point of view the test system seems to be a suitable approach for interior noise field characterisation. In order to present some results in this report, one intensity case is given in Figure 25. Here location and level of intensity is precisely given. In Figure 26 the theoretical input of the velocity field excitation (lower surface) as far as the results of the reconstruction is given. Here, amplitude and location of the velocity field are also well reconstructed.



**Figure 24: Location of additional sources for simulation of additional sources in phase (left) and pressure field at DLA-NAH array due to the additional sources in the cabin**



**Figure 25: Reconstructed intensity from the DLA-NAH tool from B&K**

**Figure 26: Mode shape of gearbox panel and result of surface velocity reconstruction from DLA-NAH method. Test case with additional sources and high phase an magnitude error**

## 4 WP4 Integration and Application to Aircraft Cabins

### 4.1 Evaluation of new tools in aircraft environment (in hangar, engine run) and flight tests

This Work Package is devoted to integration and application of the developed tools in a real FALCON cabin during ground and flight tests. Three type of tests were planned: ground test in hangar, ground test with engine run and flight tests.

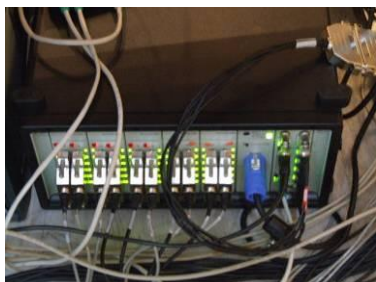
The flight tests were performed in **January 2008**.

The test installation is composed with :

- a double layer array (DLA) of microphones. This device includes 128 microphones and a camera destined to localize the array in 3D space. In order to help operator to maintain DLA in appropriate location for several minutes, the DLA will be held with a MERLIN arm vest used for movies cameras.
- 2 acquisition and conditioning units (376\*342\*194 mm and 10kg each)
- a laptop
- a reference inertial sensor (gyro) to be installed on a rigid plate
- several fiducials used as markers for the camera o locate the DLA: for each DLA measurement location the camera must see at least 4 fiducials. Fiducials can be taped, or screwed when possible
- a spherical microphone beamforming array.



DLA



Acquisition and conditioning unit



Fiducials

Four aircraft zones were measured:

#### 1. Cockpit

Despite of a very complex geometry, it seems possible to measure the cockpit. Some surfaces will be simplified. Fiducials will be taped on panels. The following surfaces will be measured :

- Windshield left and right
- Front windshield : virtual surface between windshield and instrument panel
- Ceiling
- Sideedges
- feet area on right side

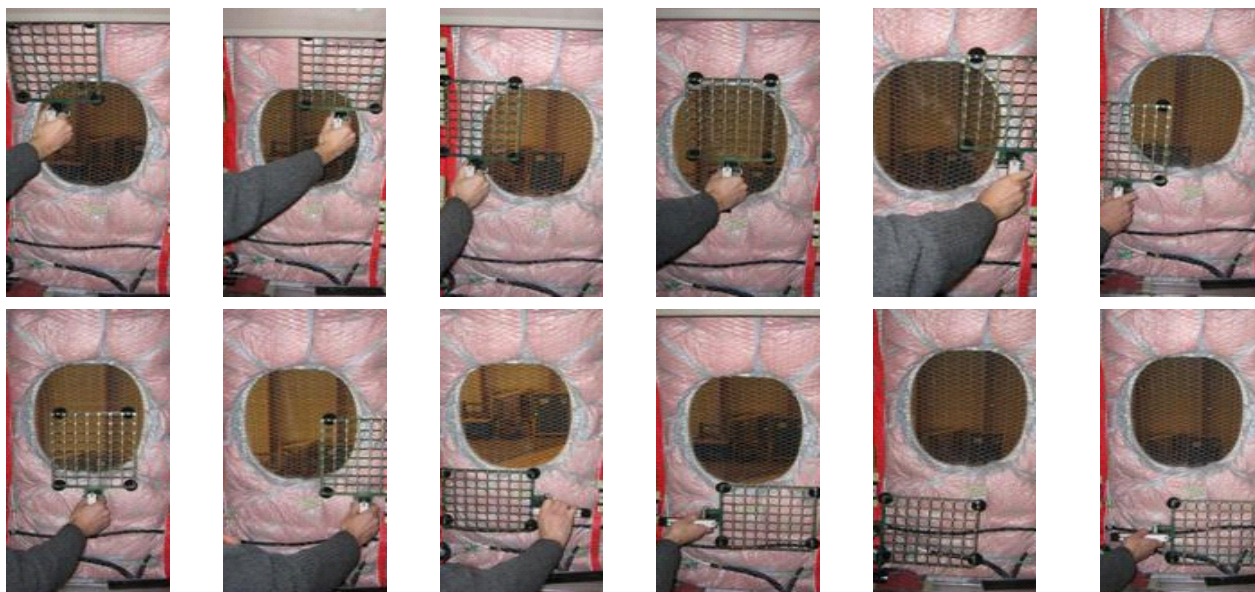
#### 2. Windows

Two windows will be measured: 1 in front part of the cabin, and 1 aft. Fiducials will be located on opposite window panels, and on ceiling.

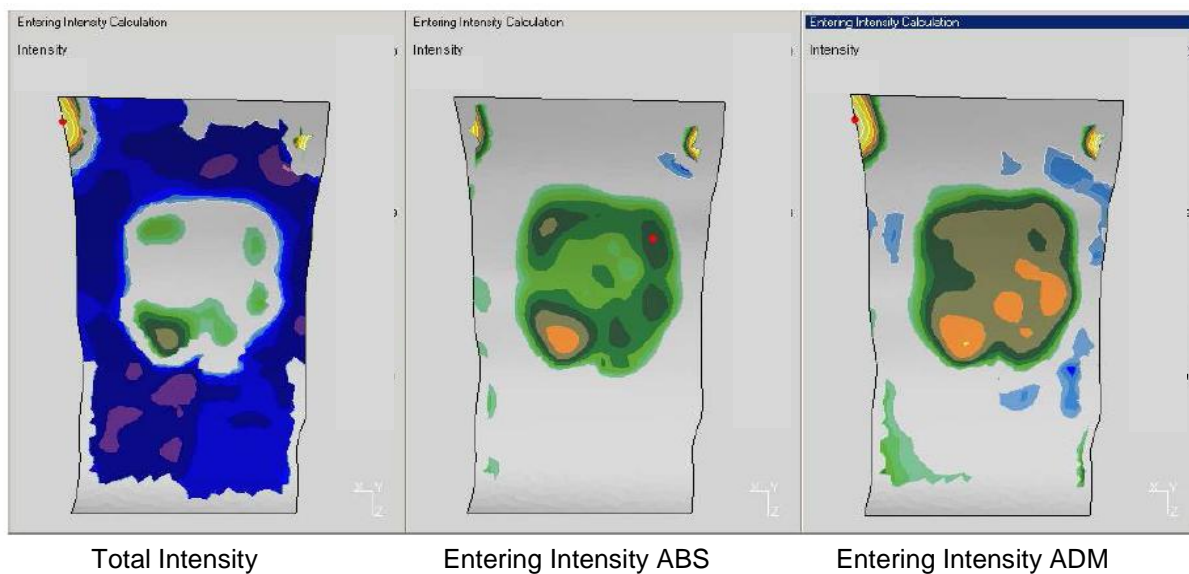
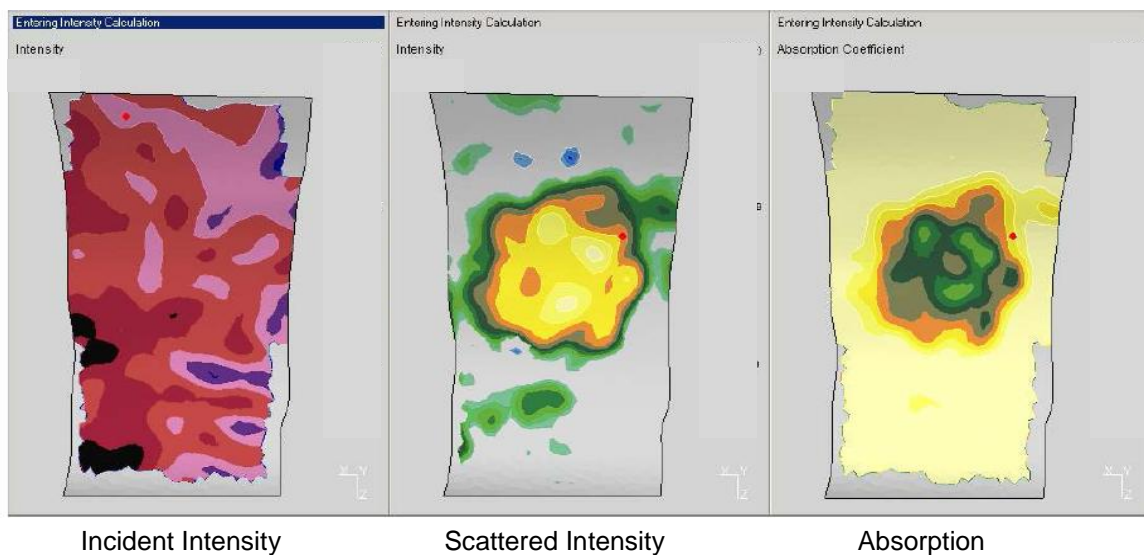
#### 3. Ceiling of the galley area

Between frames 9 to 14, and stringers 4 left to 4 right. Fiducials will be screwed on equipments ports.

A typical measurement sequence is shown in Figure 27.



**Figure 27: Measurement sequence for the rear window**



**Figure 28: Example of estimation of absorption and entering intensity (window)**

In Figure 28 an example of results obtained from the windows measurements are reported, showing the very good performances of the developed system. Dassault, as end-users, was fully satisfied about the results and the measurement procedures.

## 4.2 Application of inverse Global procedures to flight tests measurements

The objective was to analyze the results of the flight tests by means of the global procedures developed in WP3.

- A MES model of the cockpit has been created. It has been calibrated on in-flight pressure and intensity measurements. The output are the entering power flows in the whole cockpit.

- The SONAH technique has been successfully applied in the cockpit also, on areas of special interests.

Four sources have been analysed both by inverse MES and SONAH technique. We have plotted the relative weight  $\beta_i$  of each one of the 4 sources:

$$\beta_i = \frac{1}{3} \sum_{k=1}^3 \left( \frac{\Pi_i(f_k)}{\sum_{j=1}^4 \Pi_j(f_k)} \right)$$

where  $f_1 = 1$  kHz,  $f_2 = 2$  kHz and  $f_3 = 4$  kHz.

It is interesting to see what is, for all the techniques, the relative weight of the side windshield is almost the same. The most important problem is that the 2nd and 4th sources are inverted. This confirms the fact that the main sources are always well identified but that the weakest ones are difficult to classify accurately.

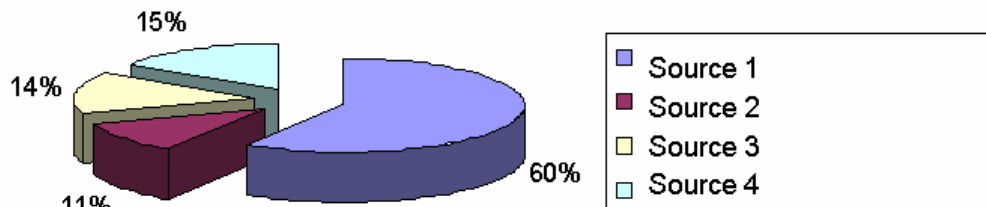


Figure 32: SONAH classification of the 4 sources in SIL frequency range

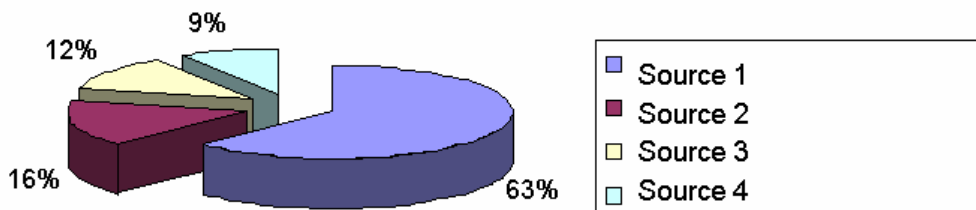


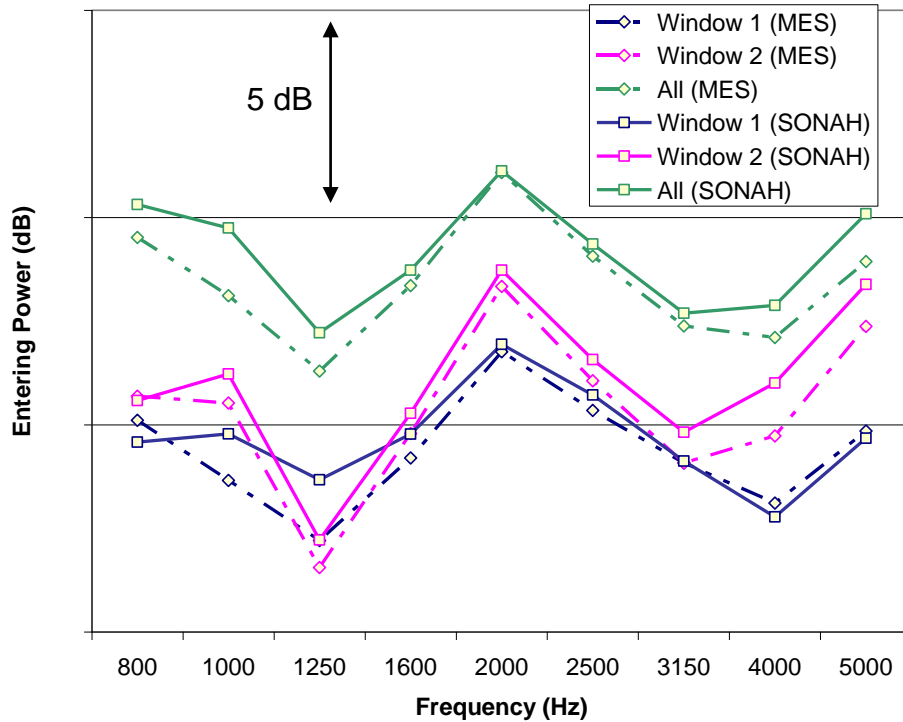
Figure 29: MES classification of the 4 sources in SIL frequency range

Note that these diagrams are not representative of all the entering power flows entering in the cockpit but only the relative weights of the entering powers identified both by Dassault (inverse MES) and B&K (SONAH).



**Comparison {DLA+SONAH} / {p-p probe + inverse MES}(Ground tests on mock-up - excitation non representative of in-flight conditions)**

The reference power flows estimated by SONAH and by the inverse MES technique in the TL\_FOP case (reference case only) have been compared.



**Figure 30: Ground tests on mock-up : Reference entering powers (configuration TL\_FOP).**

The aim is to check that there is no bias between the two methods and that the value obtained are close. The trim panel radiates very little and the variability on the estimated values of entering power is very high as it is generally with sources of second or third order. It has not been represented here.

Figure 30 shows a very good agreement between the two techniques for the whole entering power and for each of the power entering by the windows. The average difference is of around 0.5 dB, and the maximum difference does not exceed 1.5 dB.

### 4.3 WP4 Conclusions

In conclusion an "ideal" procedure of noise sources identification in an aircraft have been defined.

We consider that the two techniques are operational and given their advantages and limitation we propose a combination of the two in order to get the information needed for a global re-engineering of an aircraft cabin or cockpit.

Given the size of a Falcon's cabin and the high frequency assumptions of the MES model this procedure is reliable in the octave bands 0.5, 1, 2 and 4 kHz (SIL4 domain). For the same reasons in a Falcon's cockpit this procedure is reliable in the octave band 1, 2 and 4 kHz.

A lot of outputs calculated by SONAH can be used by the MES direct and inverse model (see scheme in Figure 31): entering intensities, total intensity values, pressure values and absorption coefficients.

Unless the two methodologies can be applied independently, it would be optimal to use them alternatively in order to have an economic and accurate way to identify the noise sources in an



aircraft. The Inverse MES method provides a global analysis of the noise sources with a rough spatial accuracy, but at a low experimental cost. It also permits to calculate noise maps. Inversely the SONAH technique is a local model that allows to focus on given areas. It provides entering intensity with a refinement equal to the gap between the microphones. The experimental cost is much higher than the inverse MES approach. A process coupling the two techniques has been proposed.

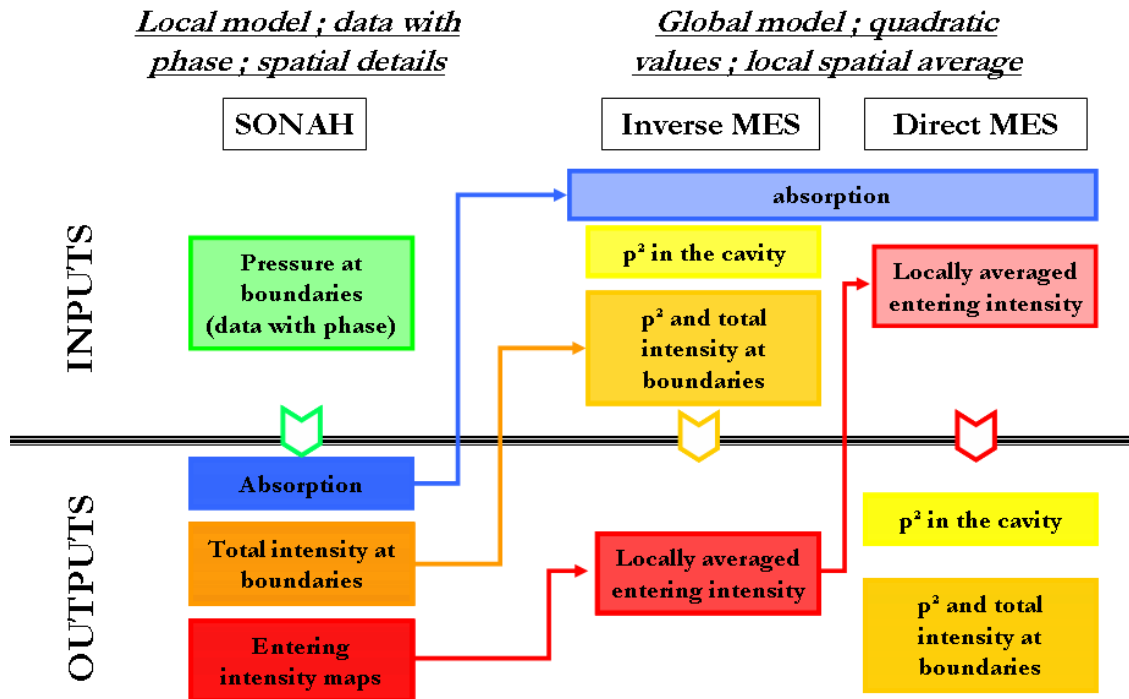


Figure 31: Connection between SONAH and inverse MES method

## 5 WP5 – Integration and Application to Helicopter Cabins

The main tasks of this Work Package are the application of the diffuse field holography techniques and inverse methods related to the small and complex helicopter cabins including mock-up and ground tests. EADS-IW, strongly supported by ECD and AGUSTA, will lead this Work Package.

The main aim is to identify leaks in the cabin and distinguish between airborne sound transmission and panel radiation, i.e. structure-borne or airborne and the back calculation to structural properties from the precise sound field results.

Several main test campaigns (Task 5.1) were performed in two different cabin mock-ups. The measurements results are processed, according to the algorithms developed in WP2 and WP3, in order to provide detailed information on incoming, outgoing and scattered contribution to the acoustic field over specific areas and for the whole mock-up cabin. A further assessment of the methods was performed for specific items in a different cabin shape, structural excitation type and main gearbox-cabin interface, with some laser vibrometer measurements performed by AGUSTA in a A109 mock-up

The possibility of using the proposed approach to solve an inverse problem of the structural propagation path into the cabin was also here evaluated (Task 5.2).

In addition the definition of requirements for the ground tests in real helicopter and the practical handling of the NAH method in the helicopter environment were here considered.

Ground tests have been realised at one ECD helicopter platform (Task 5.3). The main purpose of this test session was the determination of critical path on a real helicopter structure using the new tools, including the velocity distribution at the cabin surfaces (trim and primary) as far as the power flow into the cabin from the gear area.

### 5.1 Small cabin mock-up measurements in the BO108 and A109

The application of the innovative measurement techniques (developed in WP 2 and 3) and the suitability of their improved results for design purposes has been numerically and experimentally investigated firstly in a very basic upstream approach in two cabin and structure mock-ups (BO108 prototype – Figure 32 and A109 mock-up).

During the various test sessions laser vibration measurements and beamforming investigations of the rear cabin wall and the canopy inside the cabin and of part of the external surface of the cabin were performed by UNIVPM. ØDS carried out acoustic measurements using measurement technologies developed in WP2, notably the diffuse field acoustic holography using the double layer array. In addition AGUSTA performed some laser vibrometer measurements in a A109 mock-up [16].

The results of the laser vibration measurements on the BO108 are shown in Figure 33 (rear cabin wall and canopy) and in Figure 34 (external surface).

Typical results of the beamforming and diffuse field acoustic holography measurements performed in the BO108 are reported in Figure 35 and 36 respectively.

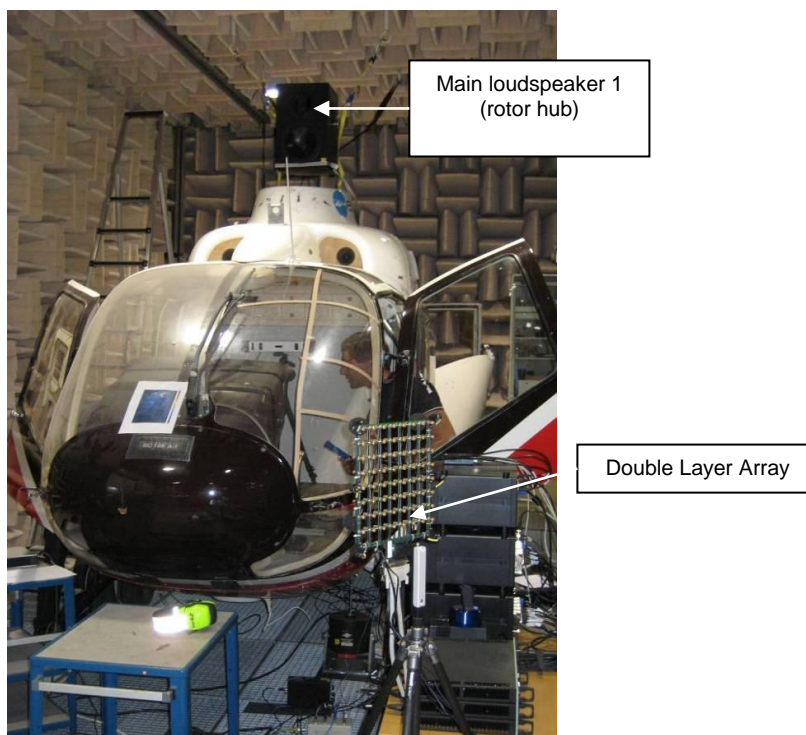


Figure 32: BO108 mock-up for engine and exhaust noise simulation

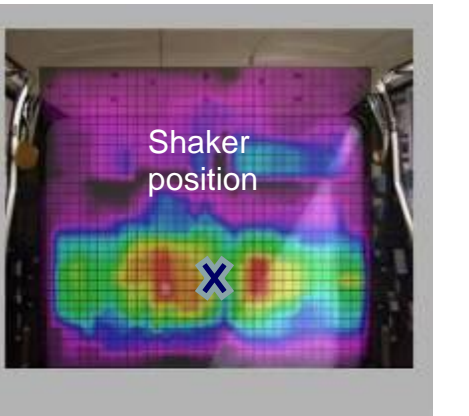
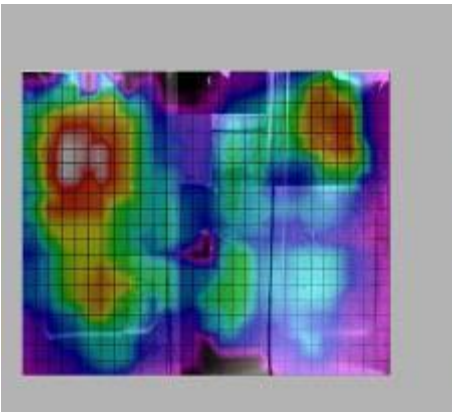
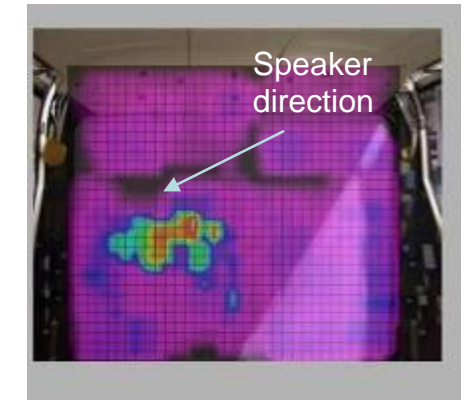
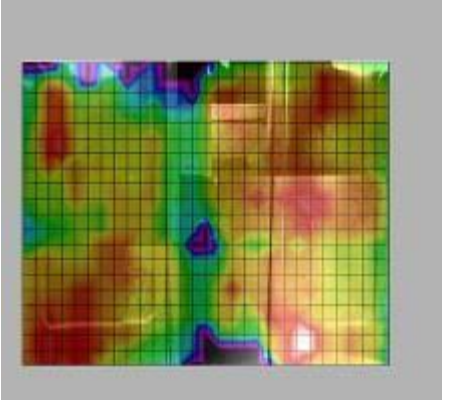
Rear Wall	Ceiling	ODS Freq.
		60 Hz
		1266 Hz

Figure 33: ODS of rear wall (left) and ceiling (right) inside the cabin

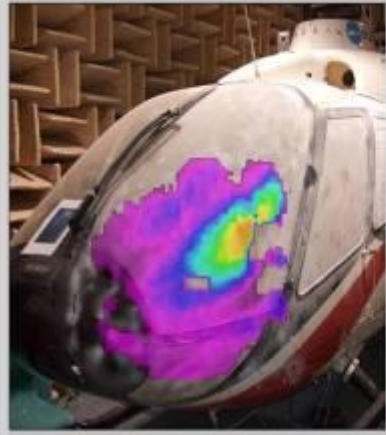
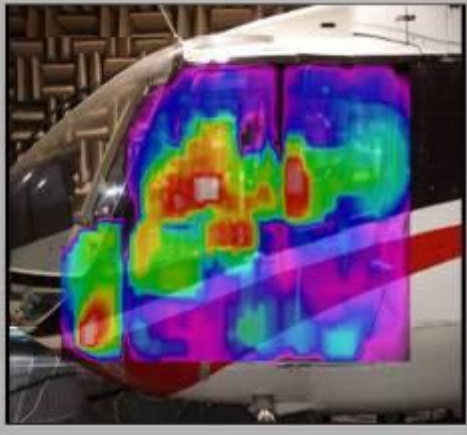
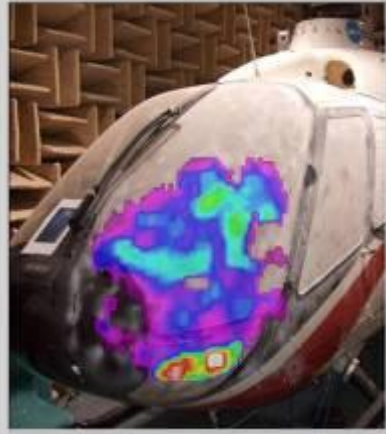
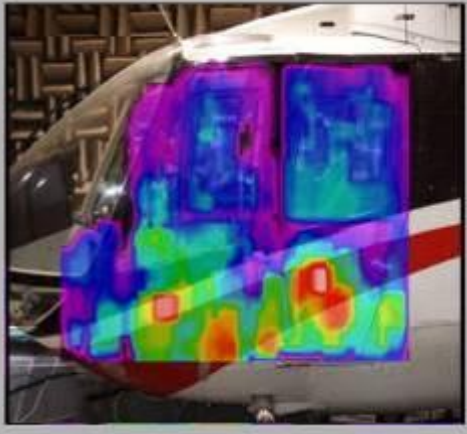
External area		ODS Freq.
		146 Hz
		666 Hz

Figure 34: External surface ODSs

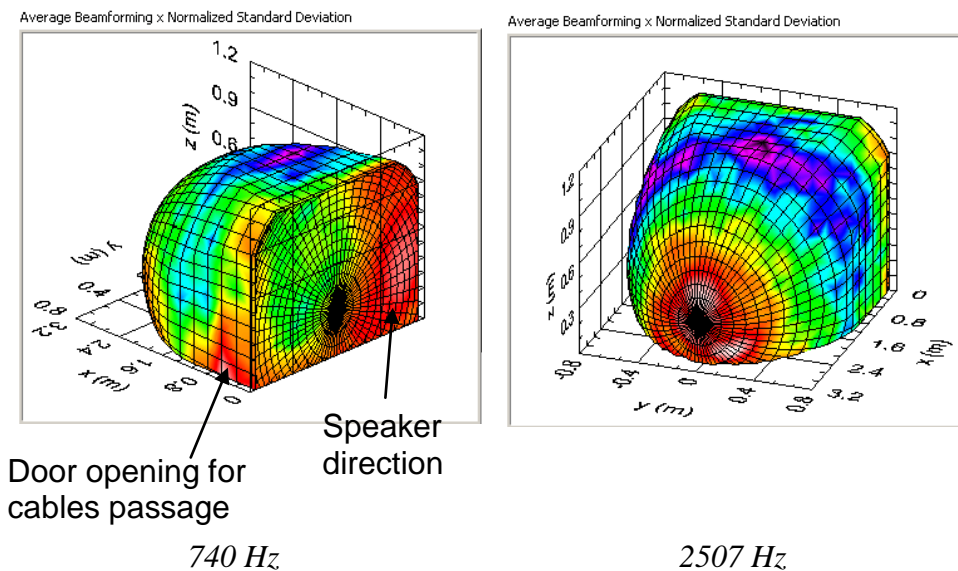


Figure 35: Acoustic power distribution obtained from beamforming measurements



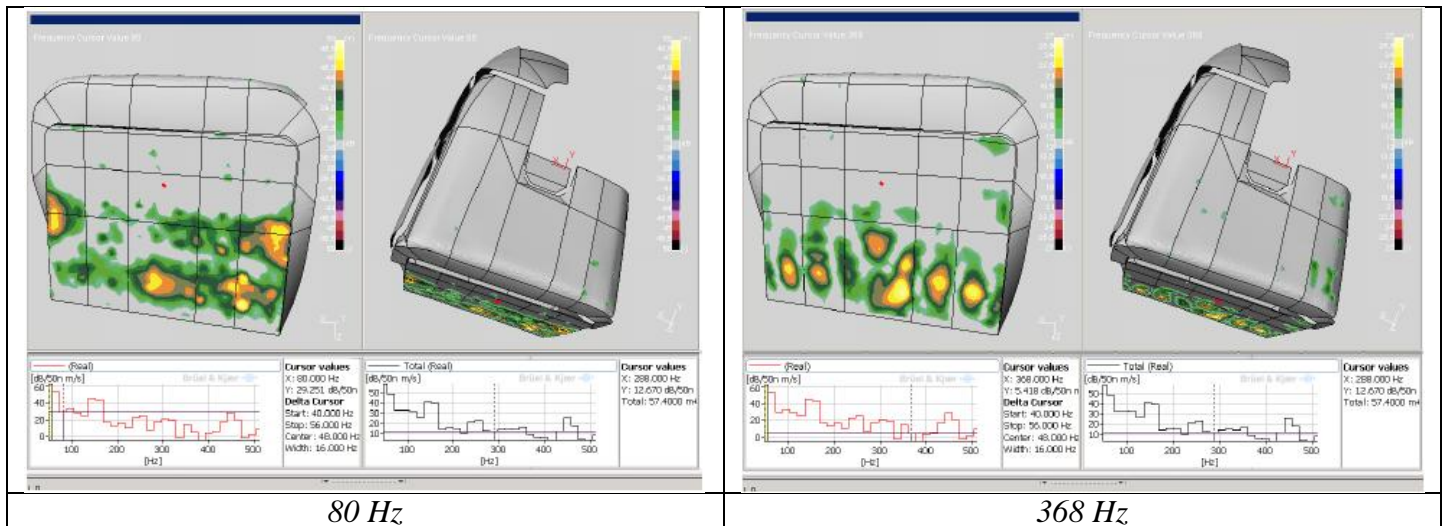


Figure 36: Reconstructed air particle velocity distribution by using SONAH algorithm

## 5.2 Sound field reconstructions by global processing

This task is devoted to the analysis of the experimental results gathered in Task 5.1. The measurement results will be processed according to the algorithms developed in WP2 in order to provide acoustic field synthesis data, i.e. to provide information on incoming, outgoing and scattered contributions to the acoustic field over specified areas of the mock-up cabin or in the whole cabin. In addition, the possibility of using the proposed approach to solve an inverse problem of the structural propagation path into the cabin has been evaluated.

The beamforming measurement data have been the used as input for the inverse method developed by FFT for the reconstruction of the vibration velocity of the cabin surface. After reconstruction of the vibrational pattern, several resonances can be retrieved within the model (see Figure 37 and Figure 38), which are correlating the different LDV measurements.

Finally the velocity fields reconstructed by the inverse model using as inputs data measured by the SONAH method at different frequencies are compared in Figure 39. The important amount of microphones placed close to the walls insure a better convergence of the solution as it can be seen from the improved accuracy of the inverse model solution.

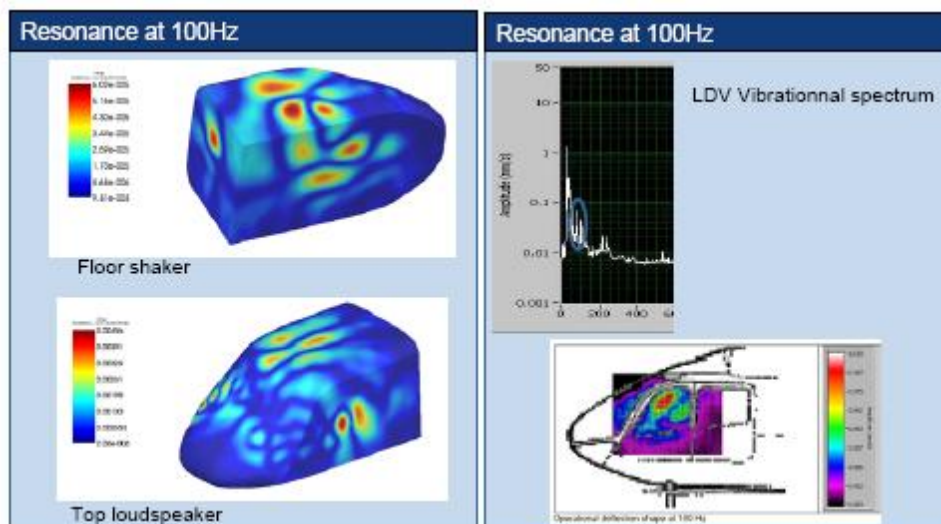


Figure 37: Reconstructed velocity field at 100 Hz



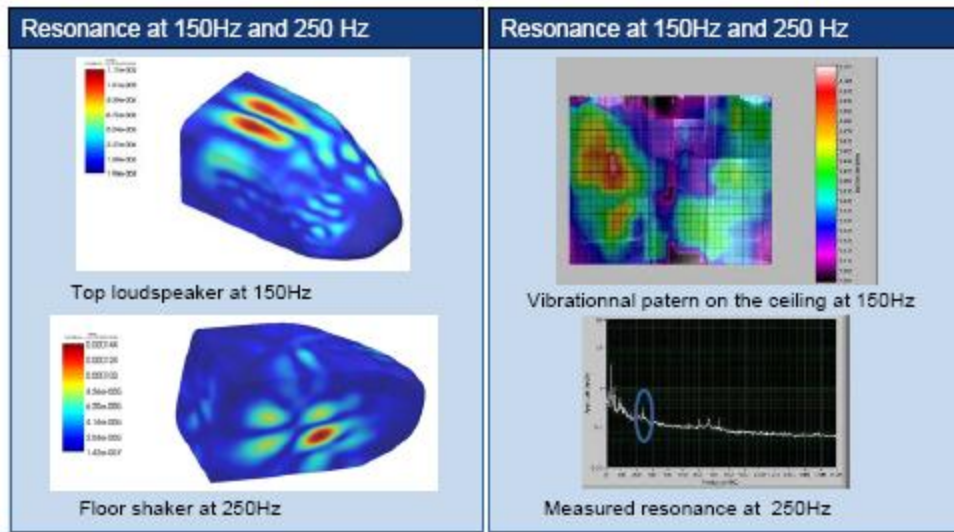


Figure 38: Reconstructed velocity field at 150 and 250 Hz

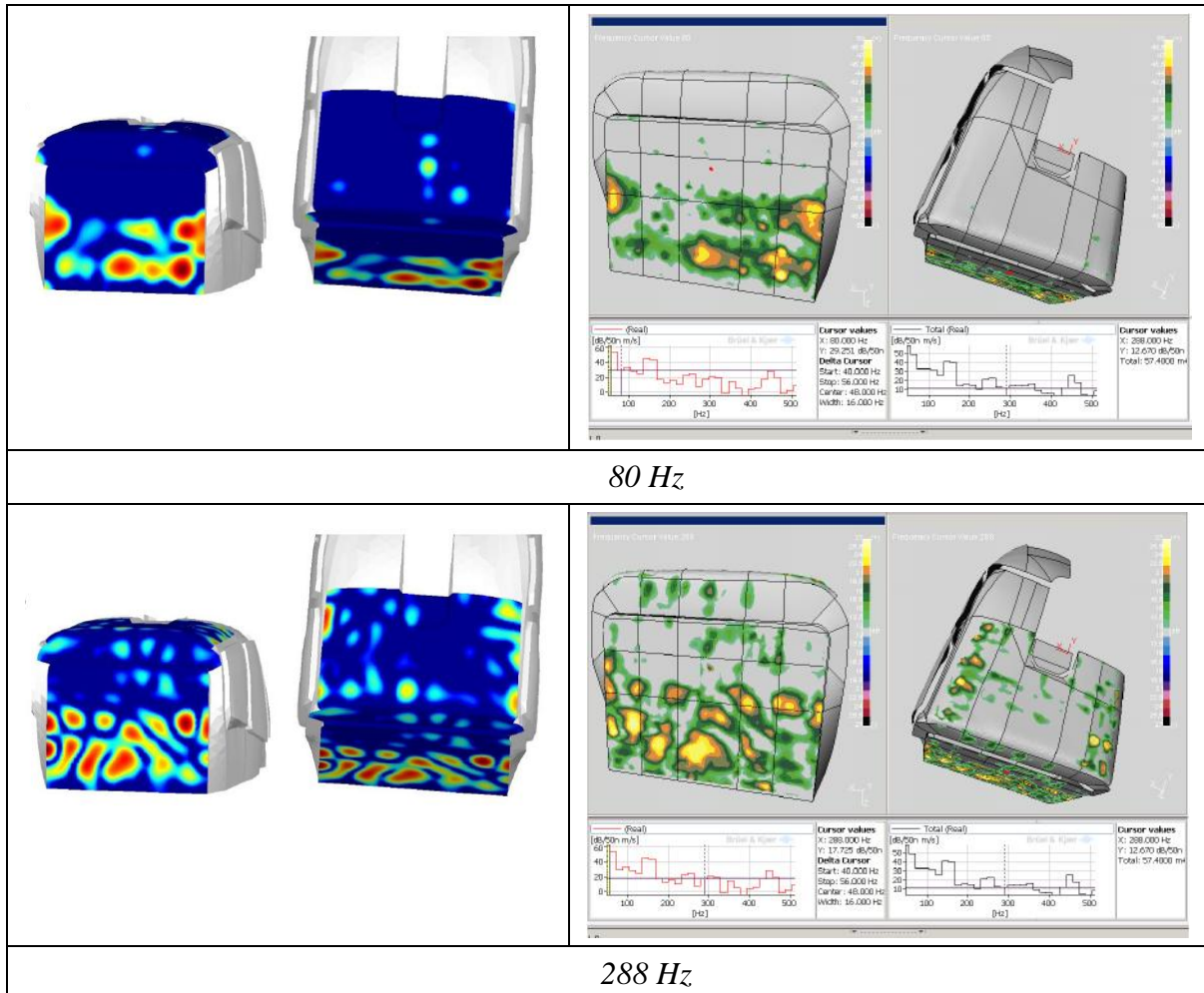


Figure 39: Reconstruction of the velocity field on the rear wall and ceiling

### 5.3 Helicopter tests

Following the successful applicability test performed in a BO108 mockup at EADS-IW acoustic laboratory, the double layer array was finally tested under operational conditions during dedicated helicopter ground runs. The measurements were conducted in June 2009 in Donauwörth on an EC145 test helicopter by a combined test crew from B&K, ØDS, EADS-IW and ECD.

The helicopter cabin presents a complex, highly reverberant acoustic cavity. Conventional intensity measurements cannot separate properly the incoming sound field from the reverberant one in such a small cabin. Thus they are not suited for measurements in the cabin under operational conditions.

The developed near field acoustic holography method using a double layer array of microphones permits to separate between entering acoustic intensity and reverberant contribution. Furthermore the high spatial resolution of the array allows the analysis of a very broad frequency range from 50 Hz to 5 kHz. The goal of the analysis is to obtain detailed information about noise source locations and their individual contribution to the global sound field.

Additionally the conducted panel contribution analysis shall determine and rank the respective contributions of defined areas to a representative position in the cabin.

The test object was an EC145 test helicopter (see Figure 40).



**Figure 40: EC145 test helicopter**

The acoustic and optical measurement set-up necessary for DLA measurements contained the following equipment:

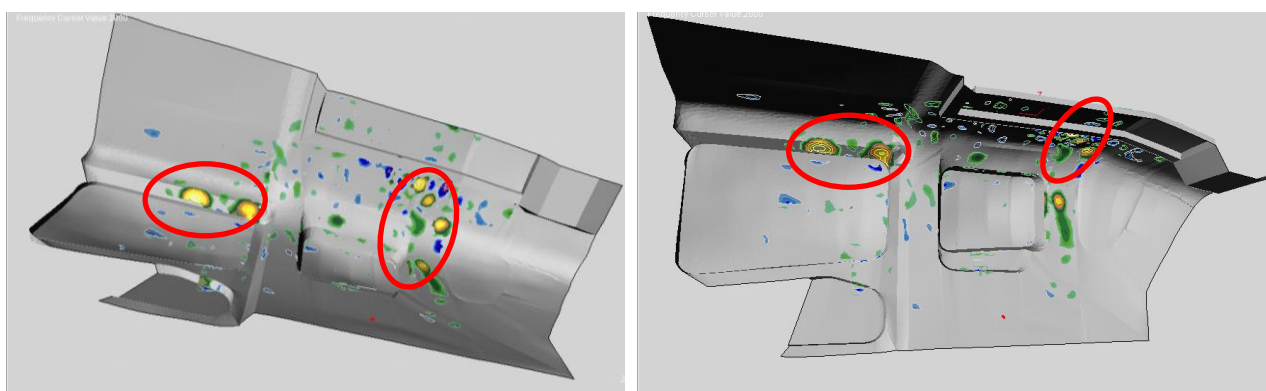
- 3 B&K data acquisition and conditioning units
- 3D Creator optical tracking system
- Double layer microphone array (DLA)
- Volume velocity source (VVS) on tripod
- Amplifier for VVS
- Laptop

The helicopter environment presented a number of unforeseen challenges for the measurement crew as well as for the system. Nevertheless reasonable solutions were found to counteract these problems so that the measurements could be reasonably continued.

In total four runs with operational rotor were performed which allowed the measuring team to cover most of the right half of the EC145 cabin.

The analysis of the DLA data obtained during operational measurements and the geometry capturing yields entering intensity surface mappings as shown in Figure 41. Henceforth yellow areas in the plots represent maximum entering intensity in the near field and thus acoustic hot-spots. Dependent on the local situation in the cabin this technique is suited either to look for acoustic leakages in the panelling or to localise panel related noise transmission or radiation respectively.

For instance, in Figure 41 is given the entering intensity map for the dominant 2000 Hz band, because the human perception is focused on frequencies between about 500 Hz and 4000 Hz and therefore this range is the one mostly influencing the annoyance of passengers. Unfortunately some gearbox tooth meshing frequencies are situated in this very frequency range.



**Figure 41: Intensity mapping at 2000Hz - view from the bottom and from the side of the cabin**

Interestingly the entering intensity levels in this frequency range are not continuously spread over the whole roof area, but appear instead as very intensive peaks at some points in the ceiling. Looking at the real installation situation we can see, that the highest levels correlate well with the guiding rail of the sliding door and the transition of two adjacent panels in the ceiling, directly below the gearbox. This result seems very plausible. Obviously these locations act as acoustic leakages and consequently a further increase of just the transmission loss in the ceiling panel would be probably without noticeable benefit for the entering intensity in this frequency band.

## 5.4 WP5 Conclusions

The DLA-NAH and Panel Contribution analysis are promising technologies with unique possibilities for helicopter acoustics. They are conditionally applicable to helicopter ground runs but not yet mature enough for in-flight measurements.

Their main advantages are:

- Possibility of accurate acoustic mapping of highly reverberant cabin,
- Separation and quantification of incoming and reverberant sound contribution,
- With the optical positioning system, ability to easily capture detailed surface geometry.

Nevertheless some drawbacks have been evidenced:

- Long duration of acoustic surface scan (some hours with turning rotor),
- Hand held scanning by standing person difficult during flight,
- Optical positioning system quite sensitive to sun radiation and vibration.

## 6 Results and Conclusions

The main scientific and technological results obtained within the CREDO project are summarized below.

### **Double-layer Near Field Acoustic Holography system for detailed and accurate measurements in reverberating fields, including algorithms and theoretical methods able to separate sound power entering the cabin from the reverberating one:**

This method has been used for the local determination of the local “entering” sound intensity in a reverberant environment with a number of independent sources. This quantity can be defined in several ways, but may broadly be interpreted as the sound intensity that would be measured locally if the environment is anechoic and there are no other independent sources. It differs from the sound intensity measured directly in the reverberant environment, which contains contributions from the reverberant sound field as well as direct contributions from other sources. These two fields together shall be denoted the background field. A double layer array (DLA) can be used to decompose a sound field into two components with opposite direction of propagation. This property may be used to separate the background contribution from the total sound field to leave the required Entering Intensity. Essentially the DLA is placed close to the source and the local sound field is decomposed into inward-propagating and outward-propagating components.

The DLA/SONAH system is considered to represent mature technology in terms of usability and accuracy of results, in particular with the integration of the 3D-Creator position measurement system. In general, good results have been achieved on the extraction of the entering sound intensity. The method requires two partial measurements the first one needed to determine absorption coefficient of the source surface.

### **Development of concepts and methods for a full array based Panel Contribution Analysis in reverberating conditions:**

The goal in PCA is to estimate the contribution to the sound pressure at a chosen listening position (pear) from a selected panel area.

Just like the Entering Intensity (EI) measurement, the PCA measurement requires two partial measurements where the results of the two are combined at a grid of points on/near the panel surfaces: - a non-operational measurement of Frequency Response Functions (FRF’s) from volume velocity  $Q$  at the listening position to the pressure (and the normal component of the particle velocity) on the panel surface and - an operational measurement to estimate the operational normal component of particle velocity (and the operational pressure) at the same positions on the panel surface.

The proto-type software development takes advantage of the close relationship with the EI measurement. The PCA system has been applied and successfully tested in helicopter measurements.

### **Feasibility study for the application of p-u probe sensors to measure directly the sound intensity entering the cabin in local and global procedures. Improvement of knowledge on p-u sensors behaviour by analysis of detailed calibration results and accurate comparisons with other measurement techniques:**

The p-u probe consists of two different sensors. The double hot-wire element measures the sound velocity ( $u$ ) and a small electret microphone measures the sound pressure ( $p$ ) at approximately the same position. In literature the hot-wire sensor is called Microflown probe to denote the name of the manufacturer.

The p-u probes array has been also supplied with an automatic transverse system able to move the array at different measurement positions to perform measurements over large areas in a scan-



ning fashion. The system has been applied to measure the sound intensity in the twin chamber at Dassault and in the Alenia mock-up.

**Feasibility study for and adaptations of 3D beamforming to provide acceptable results in a closed reverberating environment at medium-low frequencies. This requires the development of new concepts for the measurement apparatus and procedure and for the processing algorithms:**

A 3D beamforming system has been developed together with an automatic positioning device in order to move the microphones array at different positions and to cover, with a limited number of microphones, a large volume as it can be the cabin of an aircraft or helicopter. This will reduce significantly the cost of the system. Obviously, the applicability of this strategy is based on the hypothesis of stationarity of the acoustic field to be measured. If this hypothesis is satisfied, the acoustic data measured at each position can be matched by using a reference microphone fixed in space.

The beamforming outputs obtained from the data measured at the different positions can be also averaged together. Being the noise source fixed in space and the reflections randomly distributed, the averaging process will reduce the reflections contribution to the overall result and enhance the source one.

**Feasibility study for and adaptations of scanning Laser Doppler Vibrometry to provide acceptable results in a cabin environment (i.e. limited available space) in flight conditions (i.e. interfering inputs due to vibration at the base):**

The vibration measurements inside the aircraft cabin will allow to precisely locate structure-borne sources and to remove them by appropriate structural modifications or by applying suitable active vibration absorbers. In the last case the position of every absorber must be very precise, therefore to accurately determine the optimal locations it would be necessary to perform a high-spatial density measurement on the cabin surface. This kind of measurements can be performed with a Scanning Laser Doppler Vibrometer (SLDV), which, thanks to a scanning system, can measure the surface vibration velocity over a dense spatial grid in a short time, depending, of course, on the acquisition parameters (sample rate, number of samples, number of averages).

Hence, the SLDV has to be placed inside the cabin and it must perform the measurement when the cabin is forced into vibration by controlled sources (i.e. shakers or/and loudspeakers) or by external sources excited in operating conditions (in ground or flight tests). Consequently, the laser head, that lean on the cabin floor, will experience the same vibration as the surface where it has to measure, this introducing a level of uncertainty in the measurement itself. For that reason, it has been deeply studied the dependence of the measurement uncertainty on the floor vibration and designed a vibration isolation system to be applied if the uncertainty is unacceptable.

**Development of specific Design of Experiment (DoE) procedures for cabin array-based noise measurement in highly reverberating environment and uncertainty evaluation:**

The DOE is a powerful method to forecast influencing parameters to the overall uncertainty of different experimental or numerical procedures. Within CREDO it has been applied only on the SONAH method but it could be worthwhile to apply it to all the techniques developed.

Performances of the B&K method for the estimation of the entering intensity were tested in several configurations with both simulations and experiments. The design of simulated experiment method applied to the entering intensity approach allowed to estimate the total intensity measurement repeatability, reproducibility, parameters most influencing the variability of the results, as the positioning of the antenna when hand held, uncertainty of the admittance – absorption coefficient which mainly depends on the sound field used for the acoustical surface excita-



tion,... In particular, the method to estimate the SONAH uncertainty gave important guidelines to perform tests in-flight where the environmental conditions are severe.

**Inverse test-based method for fibrous material characterisation with simplified experimental set-up (theory and measurement apparatus):**

An experimental technique able to characterize acoustic porous materials in aeronautic context has been developed, focusing on viscoelastic parameters (Young's modulus and loss factor) of fibrous materials. This answers to the need of porous material characterisation for simulation purpose.

Absorption and transmission measurements involving a foam and fibrous materials have been performed. It is shown that fibrous materials are very efficient.

Being classical methods for determining absorption and transmission loss based on measurement in anechoic chamber are very costly, a lower cost experimental set-up suitable for all materials including fibrous materials in the longitudinal direction, has been designed. The proposed method is based on the compression of a porous sample, as in quasi-static measurements, but putting the sample in cavity to minimize the influence of the surrounding fluid. Effect of the fluid inside the cavity has been investigated numerically.

**Development, implementation and verification of new alternative inverse FEM for low-medium frequency range for global model of the acoustic power inside a closed reverberating space (i.e. a the cabin). This approach is mainly based on the innovative method of the pellicular modes:**

A fully-functional software product embedding the SHAMPOOING (Software for Harmonic Acoustic Modelling Providing Optimal Output Information on Noise Generation) methodology has been developed.

The applied method is an alternative inverse approach based on the use of acoustic eigenmodes of a thin air volume surrounding the radiating surface. The approach is based on a hierarchical description of the source in terms of pellicular acoustic modes i.e. acoustic modes of an infinitely thin cavity covering the radiating panels. These pellicular modes have no direct physical meaning but constitute a generic, easy to produce, hierarchical orthogonal basis in which surface unknowns can be decomposed. This is the first time that the solution is sought in terms of pellicular modes. Normal vibration velocity and surface acoustic pressure may be expressed as linear combinations of these pellicular modes, where the unknowns of the inverse problem are the complex amplitudes of each mode. This choice of unknowns is likely to stabilize the inverse procedure and avoid over-spilling phenomena. It also dramatically reduces the size of the inverse problems.

The technique has been validated by numerical simulations (producing pseudo-measurements at microphones in the vicinity of a radiating structure, extracting the above eigenmodes, solving the inverse problem, measuring the robustness of the procedure by adding some extra noise to pseudo-measurements, etc.) and then applied to real test benches as for the calculation of the acoustic power inside the EADS-IW BO108 helicopter mock-up.

**Development, implementation and verification of energetic inverse methods (MES) for medium-high frequency range for global model of the acoustic power inside a closed reverberating space (i.e. a the cabin):**

The noise in aircraft cabins involving medium and high frequency acoustic waves, finite element method (FEM) or boundary element method (BEM) becomes less practical because of the time consuming on modeling and the fine mesh density fitting the very short wavelength. The classic energy method like SEA can only provide a global evaluation of response of the acoustic cavity. Therefore, the Simplified Energetic Method (Méthode Energetique Simplifiée MES) has been developed to deal with the vibroacoustics problems at medium and high frequency by

means of an analysis of wave propagation in homogeneous media. This approach is more accurate than Statistical Energy Analysis (SEA) because it can predict an inhomogeneous sound field (SEA predicts spatially averaged fields only). Compared with classical Finite Element Method or Boundary Element Method, MES is an extremely low computational cost method.

MES provide two contributions to acoustic problems. First it can be used to predict acoustic field quantities such as acoustic energy, acoustic pressures and intensities; secondly the inverse MES is used to identify the acoustic source(s) from the measurements. In order to make easier the application of inverse MES, an algorithm has been developed to take advantage of the direct and inverse MES implementation.

This method starts from local energy balance and resolves an integral equation. In room acoustics, such an equation is then used for determining the reverberant field and the decay constants in enclosures with diffusely reflecting boundaries.

The Inverse MES has been also improved by ECL in order to take into account the direct field more precisely, by coupling BEM (Boundary Element Methods) and MES. The Boundary Element Method seems to be adapted to be coupled with MES since it only needs boundary meshes. Thus, the direct field should be evaluated using a BEM formulation.

### **Integration and adaptation of experimental procedures and inverse numerical tools both at the local and global levels (e.g. MES concept modification to take into account phase differences):**

Concerning the low-medium frequency range the inverse numerical FEM method based on pelvicular modes has been integrated to the experimental techniques output to reconstruct the velocity distribution on the vibrating panels of the Alenia ATR42 mock-up. In this case the experimental technique used to measure the model inputs is the beamforming giving the acoustic pressure measured at different locations in the 3D volume in the cabin.

The procedure has been applied also to the EADS-IW BO108 helicopter mock-up. The inputs for the inverse model were the geometry and the acoustic pressures measured by the B&K positioning and DLA system.

Concerning the high-medium frequency range, MES method has already been studied and it is available in literature. The aim of ECL in CREDO project has been to develop a hybrid method based on MES, in order to improve the direct field calculation. So far, the direct field is being evaluated considering a lambertian directivity, which is not a correct approximation in most of the cases. Moreover, the direct field does not take into account the correlation of the waves, as for most of energy methods.

### **Procedures and tools to identify acoustical leaks in structures, with possible application to distinguish between airborne sound transmission and structure-borne panel radiation:**

The instruments developed within the project has been applied for the interior noise sources identification and for the quantification of the noise path into the cabin. The identification of the acoustic leakage is a main issue it requiring a method easy to use and applicable also in-flight test, where the diffuse sound field in cabin prevents the exploitation of classical p-p probe.

In particular in the helicopter field, the acoustic leakage has been measured on ground with an artificial noise source exciting the EADS-IW BO108 and the Agusta A109MKII mock-up.

The exterior and interior vibration of the EADS-IW BO108 has been measured by UNIVPM using the Scanning Laser Doppler technique. The entering acoustic intensity inside the mock-up cabin has been estimated by using Double Layer Array measurements performed by Bruel & Kjaer/ Llyods ODS.

In conclusion the developed procedures allowed to:

- detect weak points in the sound insulation;
- determine the acoustic path from the vibration characteristics on trim and primary structure.

In particular, it has been concluded that the DLA method is well suited to the helicopter environment if a practical handling is designed.

## 6.1 Conclusions

Similar results have never been obtained with such resolution and furthermore they have never been applied to flight tests before.

The techniques allow to identify the entering intensity into the cabin independently from the reverberant nature of the environment. Nevertheless further developments are needed for the optimization of cabin internal surfaces absorption in order to design optimal materials able to absorb the entered noise.

## References

- [1] Hald, J., Mørkholt, J., Hardy, P., Trentin, D., Bach-Andersen, M. and Keith, G., “Array based measurement of Radiated and Absorbed Sound Intensity components”, Proceedings, Acoustics’08, 2008.
- [2] Hald, J. and Mørkholt, J., “Methods to estimate the Entering Intensity and their implementation using SONAH”, Report DWP2.3 from the European project CREDO, 2007.
- [3] Hald, J., “Patch holography in cabin environments using a two-layer handheld array with an extended SONAH algorithm”, Proceedings, Euronoise 2006.
- [4] G.M. Revel, M. Martarelli and P. Chiariotti, “2D-Coherent Acoustic Intensity Estimation from Operational Scanning Laser Vibrometry Measurements for Source Identification in Reverberant Fields”, Proceeding of IOMAC-09, May 4-6, 2009 Ancona, Italy, ISBN 978-88-96225-16-5.
- [5] G.M. Revel, M. Martarelli, P. Chiariotti, A. Paonessa, “2D-Coherent acoustic intensity measurements for source identification in aircraft cabins”, Proceeding of EURONOISE 2009, October 26-28, 2009, Edinburgh, Scotland UK.
- [6] Dauchez N. , Doutres O., G enevaux J.-M., Lemarquand G., "Measure bench and method for characterising the mechanical behaviour of materials", patent WO2009040391, 2009.
- [7] Doutres O., Dauchez N., Genevaux J.M., Lemarquand G., S. M ezil, Ironless transducer for measuring the mechanical properties of porous materials, Review of Scientific Instruments, 80(1), 2010.
- [8] Ren, M. and Jacobsen, F., “Phase mismatch errors and related indicators in sound intensity measurements”, Journal of sound and Vibration, 149 (2), 1991, 341 -347.
- [9] Jacobsen, F. and Jaud, V., “A note on the calibration of pressure-velocity sound intensity probes”, Journal of the Acoustical Society of America 120 (2), 2006. pp. 830-837.
- [10] Stanislas M, Okamoto K, K ahler CJ, Westerweel J. “Main results of the second international PIV challenge”, Experiments in Fluids 39(2), 2005, pp. 170 – 191.
- [11] Raffel M, Willert CE, Wereley ST, Kompenhans J, “Particle Image Velocimetry - A Practical Guide”, Springer Verlag, 2007, 2nd edn. ISBN 3-540-63683-8.
- [12] Hart, D.P., “The elimination of correlation errors in PIV processing”, 9th International Symposium on Applications of Laser Techniques to Fluid Mechanics, Lisbon, Portugal, 1998.
- [13] Lourenco L, Krothapalli A., “On the accuracy of velocity and vorticity measurements with PIV”, Experiments in Fluids, 1995, 18, pp421 – 428.



- [14] Henning, A., Ehrenfried, K., “Frequency resolution of high-speed PIV”, Proceedings, 8th ONERA-DLR Aerospace Symposium, ODAS-2007, Goettingen, 2007.
- [15] Henning, A., Käpernick, K., Ehrenfried, K., Koop, L. and Dillmann, A. “Investigation of Aeroacoustic Noise Sources by Simultaneous PIV and Microphone Measurement”, 13th Int. Symp on Appl. Laser Techniques to Fluid Mechanics, Lisbon, Portugal, 2006.
- [16] P. Castellini, P. Chiariotti, G.M. Revel, E.P. Tomasini, F. Cenedese, A. Perazzolo, "Scanning Laser Doppler Vibrometer Measurements Inside Helicopter Cabins in Running Conditions: Problems and Mock-up Testing", 9th Intl Conference on Vibration Measurements by Laser and Non-Contact Techniques, Ancona, 22- 25 June 2010.

**CONTACT DETAILS - CREDO PROJECT**

<b>ORGANIZATION</b>	<b>NAME and SURNAME</b>	<b>E-MAIL</b>
<b>Università Politecnica delle Marche UNIVPM</b>	Enrico Primo Tomasini	e.p.tomasini@univpm.it
<b>Università Politecnica delle Marche UNIVPM</b>	Gian Marco Revel	gm.revel@univpm.it
<b>Università Politecnica delle Marche UNIVPM</b>	Milena Martarelli	m.martarelli@univpm.it
<b>Alenia Aeronautica S.p.A.</b>	Antonio Paonessa	apaonessa@aeronautica.alenia.it
<b>Brno University of Technology Dept. of Control and Instrumentation</b>	Petr Benes	benesp@feec.vutbr.cz
<b>Brüel &amp; Kjær Sound &amp; Vibration Measurement A/S</b>	Jørgen Hald	JHALD@bksv.com
<b>DASSAULT AVIATION</b>	Pierre Hardy	pierre.hardy@dassault-aviation.com
<b>Deutsches Zentrum für Luft und Raumfahrt e.v. (DLR)</b>	Lars Koop	lars.koop@dlr.de
<b>EADS Deutschland GmbH</b>	Alexander Peiffer	Alexander.Peiffer@eads.net
<b>ECOLE CENTRALE de LYON (ECL-LTDS)</b>	Mohamed Ichchou	mohamed.ichchou@ec-lyon.fr
<b>EUROCOPTER Deutschland GmbH</b>	Rainer Heger	rainer.heger@eurocopter.com
<b>Free Field Technologies SA</b>	Jean-Louis Migeot	jean-louis.migeot@fft.be
<b>Université du Maine, Laboratoire d'Acoustique</b>	Dr. Olivier Doutres	olivier.doutres@univ-lemans.fr
<b>Ødegaard &amp; Danneskiold-Samsøe A/S</b>	Martin Bach-Andersen	martin.bach-andersen@lr-ods.com
<b>Politecnico di Milano Polo Regionale di Lecco</b>	Giovanni Moschioni	giovanni.moschioni@mecc.polimi.it
<b>Università di Napoli Federico II</b>	Francesco Marulo	francesco.marulo@unina.it
<b>Agusta S.p.A.</b>	Fausto Cenedese	fausto.cenedese@agustawestland.com