



**Project acronym: BME Clean Sky 032**

**Project full title: Resin, Laminate and Industrial Nanoparticles Concept and Application. Industrialization.**

**Grant agreement no: 270599**

## **Final publishable summary**

February 2013



## **Table of Contents**

<b>1. Executive summary .....</b>	<b>3</b>
<b>2. Summary description of the project context and the main objectives .....</b>	<b>4</b>
<b>3. Description of the main S &amp; T results/foregrounds .....</b>	<b>7</b>
WP1 Nanoparticle dispersion in epoxy resins.....	7
T1.1 Selection of nanoparticles and other materials.....	7
T1.2 Nanoparticle dispersion in epoxy resin and properties characterization .....	12
Significant results: .....	16
WP2 Development of polymer micro and nanofibres loaded with nanoparticles.....	16
T2.1 Processes for polymer microfibers .....	16
T2.2 Production of CNT filled polymer microfibers and graphitization.....	17
T2.3 Development of prepreg tapes and composites made thereof.....	21
Significant results .....	23
WP3 Thermal and electrical conductivity testing .....	23
T3.1 Thermal and electrical conductivity test.....	23
Significant results: .....	25
WP4: Mechanical evaluation.....	26
T4.1 Mechanical testing .....	26
Significant results: .....	28
WP5: Industrialization studies .....	28
T5.1 Industrialization studies .....	28
Significant results: .....	31
<b>4. The potential impact (including the socio-economic impact and the wider societal implications of the project so far) and the main dissemination activities and exploitation of results .....</b>	<b>32</b>
Description of the potential impact (including the socio-economic impact and the wider societal implications of the project so far) .....	32
Main dissemination activities:.....	34
Relevant contact details: .....	37

## 1. Executive summary

This project aimed at development of hybrid epoxy resin composites, where both the matrix and the carbon fibre reinforcement contain nanoparticles, in order to improve the mechanical, electrical and thermal properties of the carbon fibre reinforced aeronautical structures.

In **WP1** two kinds of untreated multiwall carbon nanotubes (MWCNTs) have been characterized by scanning electron microscopy (SEM) and atomic force microscopy (AFM) tests in terms of aggregate structure. Composites with two MWCNT types have been compared through mechanical tests. Based on mechanical test results Bayer BT C150 HP MWCNTs have been selected for further use.

Rheological and mechanical characterization of four epoxy resins combined with six curing agents has been performed with multiple amounts of MWCNTs. For further use the low viscosity AH-12 epoxy resin with T-111 curing agent has been chosen.

According to the results of the mechanical and electric conductivity tests performed on MWCNT/carbon fibre (CF) reinforced hybrid composites prepared by vacuumbag technology 0.3 wt% MWCNT filling has been selected.

The masterbatch dispersion method has been characterized and compared to a competitor direct mixing technology.

**WP2** aimed at developing processes to produce polymer nanofibres loaded with carbon nanotubes (CNTs), for CF production.

The concentration and viscosity of polyacrylonitrile (PAN) solutions were optimized for electrospinning. A novel technique involving both mechanical and ultrasonic mixing was developed for dispersion of CNTs and the efficiency was evaluated.

Nanofibre samples were produced with NanoSpider™ method. The nanofibrous mats were examined by SEM and AFM. The average fiber diameters were found to be approximately 200 nm.

The stabilization and carbonization processes were optimized using differential scanning calorimetry (DSC), thermogravimetry (TG), Fourier transform infrared spectrometry (FTIR) and wide angle X-ray spectroscopy (WAXS). The suggested heat treatment program consists of a hot-stretching, a multi-step stabilization taking 10 minutes, respectively, and a two step carbonization at higher temperatures. Carbon nanofibers with a diameter of approximately 100 nm were successfully produced.

In **WP3** four samples (unwoven carbon nanofabric reinforced MWCNT filled epoxy, unwoven carbon nanofabric reinforced epoxy, CF reinforced MWCNT filled epoxy and CF reinforced epoxy) have been prepared to characterize the effect of CNT filling and to be able to compare the developed nanofiber reinforced composites to the conventional micro-sized CF reinforced ones in guarded hot plate thermal conductivity and four-pin surface resistivity measurements.

The thermal conductivity of the samples has increased by approximately 3 times with the inclusion of MWCNTs in the carbonized nanofibers. The electrical conductivity is significantly higher in case of MWCNT containing carbonized nanofiber reinforced composites compared to the CF reinforced composites. The inclusion of MWCNTs in the PAN precursor fibers is essential for the formation of conductive carbonized nanofibers by the mediation of the formation of a more perfect and aligned graphite structure.

In **WP4** the mechanical evaluation of the samples produced in WP3 has been performed through tensile, bending and Charpy impact tests. The results showed that carbonized PAN reinforced composites have approximately one order of magnitude lower mechanical properties than the composites reinforced with conventional CFs. MWCNT filling of the matrix has beneficial effects on almost all mechanical properties of the carbonized nanofiber reinforced composites, because the effect of matrix properties is more pronounced. The MWCNT filling of the carbonized PAN nanofibers is beneficial in case of static properties.

In **WP5** possible way to set up the production line of precursor tapes, their stabilization and carbonization was proposed. A new spinneret system was developed and patented, which allows formation of nanofibers with high throughput. In case of industrial-scale production some of the results of former WPs can be applied directly, but some others only with caution. The technologies and their parameters for industrial-scale production were determined.

## 2. Summary description of the project context and the main objectives

The aim of this project was to develop hybrid epoxy resin composites, where both the matrix and the carbon fibre reinforcement contains nanoparticles, in order to improve the mechanical, electrical and thermal properties of the carbon fibre reinforced aeronautical structures. The dispersion of the selected nanoparticles in epoxy resin matrix is carried out by a three step masterbatch technique, resulting in low viscosity, evenly dispersed carbon nanotubes (CNT) filled epoxy resin systems ready for industrial size use. Rheological, morphological and spectroscopic (Raman, Fourier Transformation Infrared (FTIR)) characterization of the loaded materials is carried out. Polymer nano/microfibers loaded with CNT and other nanoparticles, which serve as precursors for carbon fibres, are produced by electrospinning method from polyacrylonitrile (PAN)/ dimethylformamide (DMF) solution of CNTs. Optimal parameters for the graphitization of these yarns are determined. CNT reinforced nanofibrous fabric are carbonized and consequently infiltrated by the CNT filled matrix mixed with the curing agent. The final outcome is a tape consisting of an epoxy/CNT hybrid matrix and carbon nanofibre/CNT yarn hybrid reinforcement. Thermal and electrical conductivity of the prepared laminate samples are determined according to standard methods in the function of dispersion method and nanoparticles loading. Static (tensile, bending, interlaminar shear strength properties), dynamic (instrumented Charpy impact, instrumented falling weight impact, dynamic interlaminar properties) and fatigue testing of the composites are carried out. After testing the mechanical, electrical and thermal properties of composites, the industrial applicability of the developed electrospinning and graphitization methods and prepreg tape product is studied.

**The objective of WP1** was to develop processes and techniques to deposit carbon nanotubes (CNTs) and other nanoparticles in a homogenous manner in epoxy resins. Extent and stability of the dispersion were to be studied.

**Task T1.1 (Selection of nanoparticles and other materials)** aimed at selection of the epoxy resin with the right performance for aeronautical requirements, and low viscosity to ease the processing after nanoparticle loading and selection of proper curing agent for prepreg production. Tensile, bending, impact, dynamic mechanical analysis (DMA) tests on the candidate resin specimens, viscosity tests on the resins were planned. Selection of the proper nanoparticles, scanning electron microscopy (SEM), atomic force microscopy (AFM) tests on the candidate nanoparticles to characterize aggregate structure, choosing needed further treatments (purification, milling, improvement of the CNT-matrix interface) were planned.

**Task T1.2 (Dispersion in epoxy resin and properties characterization)** aimed at carrying out dispersion tests using the previously developed three step masterbatch three roll milling technique and alternatives. Preparation of CNT filled epoxy batches with multiple technologies and mixing parameters. Choosing optimal mixing technology (direct mixing/masterbatch mixing) and mixing parameters according to viscosity tests of the resins and mechanical, electric properties of the specimens prepared from them were planned. Automation possibilities for the dispersion process were to be studied. Rheological, morphological and spectroscopic (Raman, Fourier transform infrared (FTIR)) characterization of the loaded materials was planned out in order to evaluate the effects of loading on the properties of epoxy resin.

Results of WP1 were planned to be summarized in **deliverable D1 Resin evaluation report (Delivery date: T0+11)** containing: Dynamic viscosity curves of the tested resins (neat and CNT filled, multiple mixing methods, parameters); mechanical and electric properties of the tested resins (DMA-heat stability, tensile, bending, impact tests, electric conductivity) in both neat and CNT filled form; selection of the optimal resin for further use.

**Objective of WP2** was to develop processes and techniques to produce polymer nano/microfibers loaded with CNT and other nanoparticles, which serve as precursors for carbon fibres. Final outcome

of this WP is a tape consisting of an epoxy/CNT hybrid matrix and carbon nanofibre/CNT yarn hybrid reinforcement.

**Task T2.1 Processes for polymer microfibers** aimed at production of nanofibres and sub-micron fibres from PAN (polyacrylonitrile) / dimethylformamide (DMF) solution. The optimal polymer concentration were planned to be selected based on former and further experiments. A self-developed electrospinning device with special liquid collector system was planned to be used to produce yarns. The key parameters: voltage, field strength, volume rate, the electrodes distance, etc. needed to be optimised. For each material it is necessary to find the best fitting process parameters.

In the frame of **task T2.2 Production of CNT filled polymer microfibers and graphitization** CNTs were planned to be mixed to the PAN/DMF solution and dispersed with stirrer and ultrasonication. Good dispersion is a key for success, so the result needs to be well-analyzed and evaluated. Ultra-fine yarns were planned to be processed from the material with our self-developed electrospinning apparatus and to be subjected to carbonization process in tube furnace. Optimal temperature program and atmosphere was to be determined by model experiments in air/oxygen/inert atmosphere in thermogravimetric apparatus. The carbonized fibres were to be analyzed by TG, Raman and SEM methods.

In the frame of **task T2.3 Development of prepreg tapes and composites made thereof** the electrospun nanostructure was planned to be carbonized resulting in CNT reinforced carbon nanofibres arranged in parallel yarns. The next step in prepreg preparation is the infiltration of the reinforcing fiber structure by the CNT filled matrix mixed with the curing agent. Evaluation of the infiltration quality, homogeneity, with feedback to infiltration, preparation of prepregs with optimal and uniform fiber volume fraction was planned. After the first manufacturing tests, the preparation of laminate coupon was planned to be carried out.

**The objective of WP3** was to characterize the thermal and electrical conductivity of the prepared laminate samples.

In the frame of task **T3.1 Thermal and electrical conductivity test** thermal and electrical conductivity of the prepared laminate samples was planned to be determined according to standard methods in the function of dispersion method and nanoparticles loading.

Results of WP3 were planned to be summarized in **deliverable D3 Thermal and electrical conductivity test results (Delivery date: T0+20)** containing results on thermal and electrical conductivity of the prepared laminate samples.

**The objective of WP4** is to evaluate the mechanical properties of the prepared laminates in the function of dispersion method and nanoparticles loading.

In the frame of task **T4.1 Mechanical testing** static testing of the specimens machined from the laminates: tensile, bending, interlaminar shear strength properties; dynamic tests: instrumented Charpy impact, instrumented falling weight impact, dynamic interlaminar properties and fatigue testing of the composites was planned to be carried out.

Results of WP4 were planned to be summarized in **D4 Mechanical evaluation report (Delivery date: T0+25)** containing results on mechanical properties of the prepared laminate samples.

**The objective of WP5** was to study the industrial applicability of results achieved in previous WP's.

In the frame of task **T5.1 Industrialization studies** the possibilities of production at industrial level were planned to be studied, as in case of significant improvement in conductivity and mechanical properties, it can be expected, that there is a need for these products in larger volume.

Results of WP5 were planned to be summarized in **D5 Industrialization Studies report (Delivery date: T0+27)**.

### **3. Description of the main S & T results/foregrounds**

In the followings the main results of each workpackage are summarized.

#### **WP1 Nanoparticle dispersion in epoxy resins**

The objective of WP1 was to develop processes and techniques to deposit CNTs and other nanoparticles in a homogenous manner in epoxy resins, furthermore to study the extent and stability of their dispersion. In the frame of tasks **T1.1 (Selection of nanoparticles and other materials)** and **T1.2 (Dispersion in epoxy resin and properties characterization)** of WP1 the selection of appropriate CNTs and epoxy resin matrix had to be carried out for the further work in the project. Investigation of rheological, mechanical and electrical properties of the prepared composites and hybrid composites has been also carried out. The proper dispersion method had to be selected to produce good mechanical and electrical performance parts suitable for the demands of the aerospace industry.

#### **T1.1 Selection of nanoparticles and other materials**

The aim of this task was the selection of the epoxy resin with the right performance for aeronautical requirements, and low viscosity to ease the processing after nanoparticle loading and the selection of proper curing agent for prepreg production. Mechanical tests have been run on the candidate resin specimens, and viscosity tests on the resins. Selection of the proper nanoparticles has been carried out according to scanning electron microscopy (SEM) and atomic force microscopy (AFM) results on the candidate nanoparticles and mechanical tests on nanocomposites prepared with them.

#### ***Selection of nanoparticles***

The selection of the nanoparticles to be used is a key for the success of the project. Numerous articles have been published on this topic. Almost all authors agree that currently the use of multi wall carbon nanotubes (MWCNTs) is the wise decision. Although single wall carbon nanotubes (SWCNTs) bear better mechanical properties, they are more susceptible to damage during dispersion and also their price is too high for current high-scale production. MWCNTs are a good alternative, because their mechanical properties are also considerably high, their electrical and thermal properties almost reach the properties of SWCNTs, and due to the cost effective chemical vapor deposition (CVD) production, they are currently available at reasonable prices. In raw form, CNTs are apolar, they are passive, show weak interfacial adhesion to polar polymeric matrices. To improve the interfacial adhesion sidewall functionalization of the CNTs can be used. During this functionalization process in the first step the CNTs are purified and activated by a potent acidic treatment, in the second step they are chlorinated and in the last step the chlorine atoms are switched to organic groups specific to the matrix being used (for epoxy matrices mainly amine or epoxyde groups, which can be integrated into the polymer backbone). This functionalization technique provides up to date low yield and therefore the prices of functionalized CNTs are exceptionally high. Apart from that, the currently widely used acidic treatment can damage and degrade the CNTs severely (the most drastically the SWCNTs, which can be almost totally disintegrated, but also MWCNTs to some extent), which leads to the loss of the mechanical property improvement by the stronger interface. Interfacial adhesion is only critical for mechanical properties. In case of thermal and electrical conductivity enhancement by CNT filling it has almost no effect.

According to these aspects two kinds of neat, untreated MWCNT candidates, HTF 110FF XT LHT (Electrovac AG, Austria) and Baytubes C 150 HP (Bayer, Germany) have been selected for the project. SEM and AFM investigations have been performed to characterize aggregate structure.

### *Preliminary mechanical tests*

To compare the mechanical reinforcing potential of the two MWCNT types tensile, bending and notched Charpy impact tests have been performed on FM-20 – T-16 epoxy resin specimens reinforced by 2 wt% MWCNTs. The MWCNTs have been mixed to the epoxy component of the resin by three roll milling on an Enrico Molteni CIEM three roll mill (roll diameter: 120 mm, 266, 144, 78 feed, center, apron roll rpm), 4 pass-throughs. The MWCNT content of the samples has been set using a Radweg WDX 2000 precision scale.

The **tensile tests** have been performed according to EN ISO 527-2 on 5-5 EN ISO 3167 type B specimens at room temperature and 45±2% relative humidity using a Zwick Z020 type computer controlled tensile tester at 1 mm/min crosshead speed. Strain measurement has been performed using a Messphysik ME46 Full Image Videoextensometer. According to the tensile test results a significant increase could be observed in case of both the tensile strength and the Young's modulus with the addition of the Bayer MWCNTs to the matrix. It can be also pointed out that the Bayer nanotubes outperformed the Electrovac nanotubes in both properties.

The **three point bending tests** have been performed according to EN ISO 178 on 5-5 specimens at room temperature and 45±2% relative humidity using a Zwick Z020 type computer controlled tensile tester at 1 mm/min crosshead speed and 64 mm support span. According to the bending test results a small increase could be observed in case of the bending strength and a significant increase in bending modulus of elasticity with the addition of the Bayer MWCNTs to the matrix. It can be also pointed out that the Bayer nanotubes outperformed the Electrovac nanotubes significantly in the bending modulus.

The **notched Charpy impact tests** have been performed according to EN ISO 179-2 on 7-7 specimens at room temperature and 45±2% relative humidity using a Ceast Resil Impactor Junior type instrumented pendulum equipped with a Ceast DAS8000 data acquisition system using a 2 J hammer and an initial angle of 150° (2,9 m/s impact speed). The notches have been prepared using a Mutronic Diadisc disc cutter with a special notching disc according to the standard.

According to the notched Charpy impact test results a significant increase could be observed in the impact strength with the addition of the Bayer MWCNTs to the matrix.

### ***Selection of epoxy matrices***

Four epoxy resin systems have been used for the tests. All resins have been produced by IPOX Chemicals (Hungary). The resins were divided into two groups, one group for the preliminary evaluation of the production, nanotube mixing technologies, capable of room temperature curing and one group of prepreg resins for the final samples.

### *Laminating resins for preliminary tests*

FM-20 bisphenol-A type, aromatic epoxy resin with T-16 amine curing agent (mixing weight ratio: 100:20): Standard epoxy laminating resin system used for preliminary tests and the comparison of the mixing technologies. Capable of curing at room temperature (pot life: 30 min). Cured at 60°C for 4 hours in a Heraeus UT20 drying oven according to producer's specifications.

AH-12 aliphatic epoxy resin with T-58 amine curing agent (mixing weight ratio: 100:40): The system consists of extremely low viscosity components, mainly used as thinner in higher viscosity resins, but capable of individual structural application. Capable of curing at room temperature (pot life: 120 min). Cured at 80°C for 4 hours in a Heraeus UT20 drying oven according to producer's specifications.

### *Viscosity tests*

For effective specimen, coupon and part production one of the most important resin properties is their **dynamic viscosity**. In case of CNT filling, the dynamic viscosity of the resin can reach such levels that make the use of productive, conventional production technologies, like resin transfer moulding



(RTM) or autoclave technologies impossible, and can also hinder the effectiveness of degassing, resulting of trapped-in voids in the final products. The viscosity of the chosen resins has been tested in steady state flow rotating operation using a TA instruments RA2000 rheometer between a rotating 40 mm diameter plane disc and a controlled temperature plane sheet at 25°C. 5 points have been recorded in each decade of shear rate, 3 minutes have been left in each point to reach equilibrium, 3 following measurements had to be in a 5% difference range before continuing to the next shear rate point. The two resins have been tested unfilled and with different MWCNT contents to describe the effect of the nanotube filling on their viscosity. The nanotubes have been mixed to the resins by 3 roll milling. The result diagram of the FM-20 and AH-12 resin can be seen in **Figure 1.1** and **1.2**, respectively.

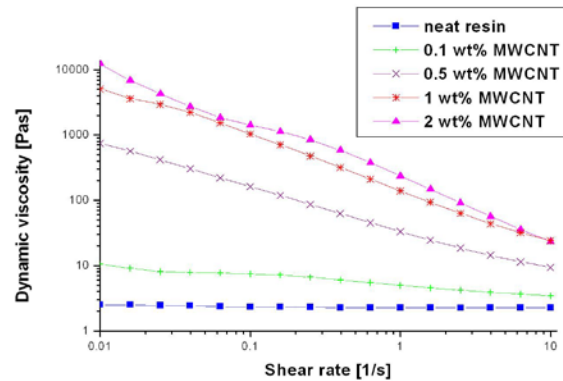

**Figure 1.1** Results of the viscosity test of the FM-20 resin in neat and MWCNT filled form

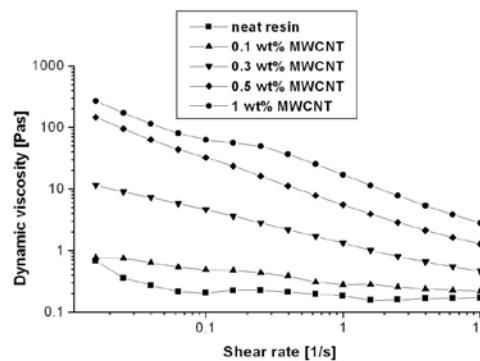

**Figure 1.2** Results of the viscosity test of the AH-12 resin in neat and MWCNT filled form

From the two result diagrams it can be clearly seen, that the MWCNT filling has increased the dynamic viscosity of both resins drastically, especially in the lower shear rate region. In case of the low viscosity AH-12 resin, its advantage can be clearly seen. The low neat resin viscosity resulted in significantly lower viscosities even in case of MWCNT filled samples. Using this low viscosity resin instead of the higher viscosity resin can make the utilization of the vacuum using, high yield composite production technologies possible. Through this more reliable, defect-free parts can be achieved.

In thermoset resin processing, the viscosity can also be decreased by the heating of the resin. Temperature ramp tests have been performed on the characteristic, high viscosity 0.5 wt% MWCNT filled FM-20 resin to characterize the effect of elevated temperature on the dynamic viscosity of CNT filled resins. The temperature increase decreased the viscosity of the applied resins significantly, but this viscosity is still too high for automated processing technologies, so another solution had to be found. The use of reactive thinners (extremely low viscosity epoxy resins) as matrix materials for the hybrid composites can be one solution for this problem. Although the CNT filling increases their viscosity as well, this viscosity remains in a manageable, processable range.

### *Prepreg resin systems*

Epovill-A epoxy and T-111/112/113 amine curing agent prepreg system (mixing weight ratio: 100:73,5): System developed for prepreg applications. The high viscosity epoxy resin has been used with three different hardeners. Curing can be carried out above 80°C. Curing has been performed at 80, 120 and 160°C for 8 hours to define the curing temperature for the best mechanical properties in a Heraeus UT20 drying oven.

AH-12 aliphatic epoxy resin with T-111 hardener (mixing weight ratio: 100:116): Low viscosity prepreg system utilizing the extremely low viscosity epoxy resin with prepreg hardener. Capable of prepreg use, curing above 80°C. Curing has been carried out at 80°C for 8 hours in a Heraeus UT20 drying oven according to producer's specifications and preliminary tests.

### *Viscosity tests*

The room temperature dynamic viscosity test results of the Epovill A resin were similar to the FM-20 system because of the similarly high viscosity. In case of CNT filled samples, the MWCNTs have been mixed to the resin by three roll milling (4 pass-throughs). From the results of the mechanical viscosity test of the MWCNT filled Epovill A resin it can be seen, that the base viscosity (around 6 Pas) has increased greatly with the addition of the resin. This can hinder the processability of the resin and the impregnation of the reinforcing fiber rowings in the prepreg.

In case of the AH-12 based prepreg system, the viscosity curves are identical to the viscosity curves of the laminating resin system, because only the curing agent and curing cycle are different. These viscosities remained in a manageable range, so the use of this resin instead of the conventional Epovill A resin can be beneficial.

### *Selection of curing agent*

For prepreg resin the selection of a suitable curing agent is necessary. The full range of available inhibited curing agents (T-111, T-112, T-113) have been tested at three different curing temperatures (80°C, 120°C and 160°C) with the conventional Epovill A epoxy resin. The selection of the suitable curing agent and temperature was **based on the mechanical performance (bending, interlaminar shear and dynamic interlaminar shear tests)** of carbon fiber reinforced composites of the resin. The specimens were cut from laminates produced by vacuum bag technology (0.5 bar vacuum has been applied on the laminates during the curing process). Each laminate contained 6 layers of Zoltek PX35 FBUD0300 unidirectional carbon fabric. The specimens and the necessary notches have been machined by a Mutronic diadisc cutting machine in respect to the fiber orientation. The curing has been performed in a Heraeus UT20 drying oven for 8 hours. The specimen preparation tests showed that The T-111 curing agent has been effective at all temperatures, the T-112 curing agent was effective at 120°C and 160°C (at 80°C the laminate remained rubbery, the conversion, formation of the crosslinked molecule was not complete) and the T-113 curing agent was only effective at 160°C. Pot tests performed with the AH-12 resin showed the same results.

The **three point bending tests** have been performed according to EN ISO 14125 using a Zwick Z020 universal, computer controlled loading frame on 5-5 standard specimens. The span has been 80 mm and the used test speed has been 2 mm/min. According to the bending tests, generally the best results were provided by the T-111 curing agent. It provided stable and reliable results also in bending modulus and in bending strength. It is also an advantage of the T-111 curing agent, that the specimen failure behaviour was much more ductile, while the T-112 and T-113 cured specimens were much more brittle. The brittleness also increased with the increasing curing temperature.

**Interlaminar shear tests** have been performed on the specimens according to ASTM D3846-94 (the ASTM standard has been chosen instead of the ISO short span beam test, because it provides more reliable data in case of thin laminates in practice) using a Zwick Z020 computer controlled loading frame at a test speed of 1.3 mm/min. To avoid buckling, an anti-buckling device specified in the

standard has been used. To minimize friction between the specimen and the anti-buckling device, the surface of the specimen has been covered with silicone grease. The tests have been performed on 5-5 specimens. From the interlaminar shear test it can be declared, that the T-111 curing agent showed the best results at lower curing temperatures. The brittleness observed during the bending tests can be the main cause of the decreasing interlaminar shear strength with higher curing temperature.

To characterize the dynamic properties of the prepared composites, a **dynamic interlaminar shear test** has been performed. For the tests 5-5 interlaminar shear specimens have been used (identical to the static interlaminar shear specimens). The dynamic loading was provided by a dynamic tensile pendulum. The tests were performed using a Ceast Resil Impactor Junior instrumented pendulum with a 15J dynamic tensile hammer started from 150° (3.7 m/s impact velocity) in instrumented operation. For data collection a Ceast DAS 8000 data acquisition device has been used. The results of the dynamic interlaminar shear tests also showed the superiority of the T-111 curing agent, it outperformed the competitors at all curing temperatures.

According to the results of the three mechanical tests, the pot curing tests and the specimen and part preparation aspects the T-111 curing agent and 80°C as curing temperature has been chosen for further tests.

The Epovill A epoxy resin T-111 curing agent system has been also tested with hybrid CNT/carbon fiber reinforcement. The MWCNTs have been mixed to the resin by 4 pass-through three roll milling. The specimen laminates have been prepared by vacuum bag technology with the same production and layup parameters like in case of the neat epoxy matrix laminates tested before.

The **three point bending tests** have been performed according to EN ISO 14125 using a Zwick Z020 universal, computer controlled loading frame on 5-5 standard specimens. The span has been 80 mm and the used test speed has been 2 mm/min. The three point bending tests provided ambivalent results. This was probably caused by the troublesome processability caused by the high viscosity of the CNT filled resins. The vacuum was not able to fully degas the laminates, and the remaining voids served as crack inducing impurities in the specimens.

**Interlaminar shear tests** have been performed on the specimens according to ASTM D3846-94 (the ASTM standard has been chosen instead of the ISO short span beam test, because it provides more reliable data in case of thin laminates in practice) using a Zwick Z020 computer controlled loading frame at a test speed of 1.3 mm/min. To avoid buckling, an anti-buckling device specified in the standard has been used. To minimize friction between the specimen and the anti-buckling device, the surface of the specimen has been covered with silicone grease. The tests have been performed on 5-5 specimens. The MWCNT filling of the matrix was also not beneficial in the interlaminar shear properties, also because of the trapped in voids in the specimens.

To characterize the dynamic properties of the prepared composites, a **dynamic interlaminar shear test** has been performed. For the tests 5-5 interlaminar shear specimens have been used (identical to the static interlaminar shear specimens). The dynamic loading was provided by a dynamic tensile pendulum. The tests were performed using a Ceast Resil Impactor Junior instrumented pendulum with a 15J dynamic tensile hammer started from 150° (3.7 m/s impact velocity) in instrumented operation. For data collection a Ceast DAS 8000 data acquisition device has been used. In the dynamic interlaminar tests the weakening was even more severe with the increasing MWCNT content and the increasing viscosity. The trapped in voids caused by the too high resin viscosity and the hindered impregnation of the carbon fiber rowings served as precracks in the system, lowering the ductility and dynamic interlaminar properties.

As a conclusion of the mechanical tests performed on the hybrid composite systems prepared using conventional prepreg resin filled with MWCNTs, it can be declared that **keeping the resin viscosity low** is of key importance for the development of a MWCNT filled high performance hybrid composite

system. To keep the resin viscosity as low as possible we chose to use the AH-12 extremely low viscosity epoxy resin with the previously selected T-111 curing agent as a matrix material for the further experiments.

The mechanical tests have been also performed on the chosen **AH-12 - T-111 prepreg epoxy system** reinforced with carbon fiber and MWCNTs. The specimen preparation and test parameters have been the same as in case of the Epovill A based system.

The **tensile tests** have been performed according to EN ISO 527-4 using a Zwick Z050 computer controlled tensile tester at 1 mm/min test speed. The strain has been measured by a Messphysik ME-46 full image videoextensometer with 50 mm gauge length. According to the results of the tensile tests, the CNT filling of the matrix caused some improvement in both the modulus and the tensile strength. The best overall performance could be observed at 0.3 wt% MWCNT content. According to the results of the three point bending tests, the CNT filling of the matrix caused some improvement in both the modulus and the bending strength. The best performance could be observed at 0.3 wt% MWCNT content. According to the results of the interlaminar shear tests, the CNT filling of the matrix caused significant improvement in the interlaminar shear strength at all MWCNT contents.

**DMA tests** have been performed on cast specimens without carbon fiber using a Perkin-Elmer Diamond DMA tester at 1 Hz frequency from -50 to 200°C. The DMA tests showed a decreasing tendency of the glass transition temperature above 0.3 wt% MWCNT content, up to that no significant change could be observed.

The **electrostatic properties** of the hybrid composites have been measured through surface resistivity measurements according to IEC 60093. The tests have been performed using an ITECO GIGALAB digital Mega-Ohmmeter. The diameter of the rubber electrodes was Ø63 mm, their thickness 4 mm, and their distance from each other was 25 mm, they have been installed in electromagnetically shielded housings. The surface resistivity was below 1 kΩ (the lower end of the working range of the device) in case of all samples which is the range of electrically conductive polymers, so the percolation of the MWCNT network has been achieved.

According to the results of the mechanical and electrical tests the **AH-12 – T-111** epoxy resin has been selected for further use in the project. It provides good mechanical performance at low resin viscosity and the surface resistivity measurements provided also promising results. 0.3 wt% MWCNT content has been selected as the optimal nanotube content for the further specimen preparations combined with MWCNT filled carbonized nanofibers.

## **T1.2 Nanoparticle dispersion in epoxy resin and properties characterization**

To develop a competitive hybrid composite system, good nanoparticle dispersion has to be achieved. Although in the first decade after their discovery, ultrasonic stirring has been the dominant mixing method, nowadays high shear mechanical mixing technologies have taken its place because of productivity reasons. In the project we have used a previously developed three-step masterbatch technology for the dispersion of the nanotubes in the epoxy resin, and compared it to the concurrent direct mixing technology. The dispersion tests have been performed on the selected AH-12 low viscosity epoxy resin with different MWCNT contents.

### ***Dispersion tests***

#### ***Masterbatch technique (MB)***

The 3-step masterbatch technique (**Figure 1.3**) was developed to be able to utilize the mixing potential of three roll milling for low viscosity resins like the AH-12 used. In the first step an 8 weight% nanotube filled AH-12 masterbatch has been premixed for 4 hours using an IKA RW-16 overhead stirrer equipped with a Heidolph TR20 turbine type impeller. The so prepared mixture contained large, visible aggregates but its viscosity increased to the level where three roll milling became available (the neat,

and loaded but no pre-dispersed resin flows down in the gap between the rolls of the three roll mill). In the second step the masterbatch has been mixed on an Enrico Molteni CIEM three roll mill, 4 pass-throughs have been carried out to reach the lowest achievable particle size. In the third step the almost solid masterbatch has been thinned with neat resin to the desired filler contents.

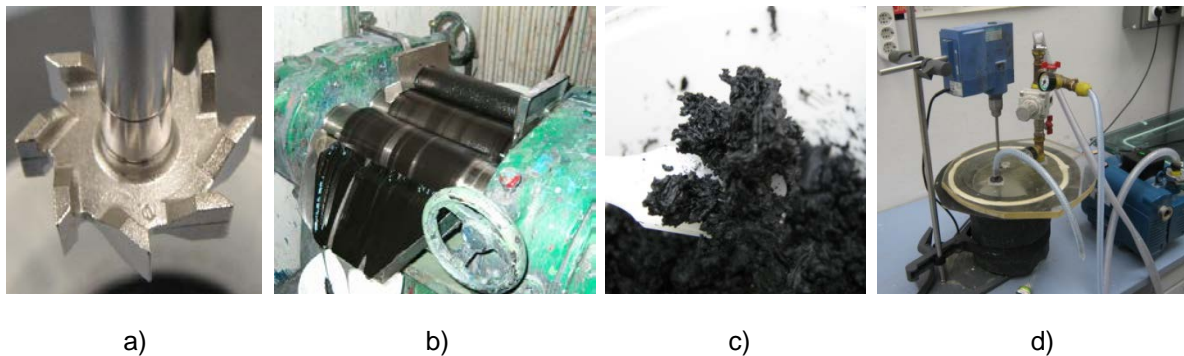

**Figure 1.3** The steps of the masterbatch (MB) mixing technology: premixing by overhead stirrer (a), three roll milling (b), masterbatch (c), thinning under vacuum (d)

#### *Direct mixing technique (DM)*

The direct mixing technique has been carried out using an IKA magic LAB® mixer with DISPAX-REACTOR® module. The machine has been set up for batch operation with constant reflux to the feed hopper. Each resin-nanotube batch has been mixed for 15 minutes at 15000 rpm. During the mixing constant stirring of the material in the hopper and cooling of the reactor has been provided.

#### ***Dispersion characterization***

The direct mixing and masterbatch technologies have been compared in terms of particle size, viscosity and mechanical tests.

To compare the maximal particle size, the grinding, aggregate disintegrating effect of the two mixing technologies, fineness of grind tests have been performed on the prepared MWCNT filled samples using an Elcometer 2020/2 grindometer according to EN ISO 1524. The fineness of grind values (the maximal particle size in microns) clearly showed that the masterbatch technology is superior to direct mixing. During three roll milling the nearly zero gap size causes an effective grinding action besides the high shear, which can effectively grind the MWCNT aggregates. This mechanical grinding effect is not present in direct mixing, where the collision of the aggregates can be the main cause the disintegration of the aggregates. The higher particle size values at higher MWCNT loadings are probably caused by reaggregation. Reaggregation can be fully avoided, if the masterbatch is only thinned with neat resin to the desired nanotube content just before prepreg or part manufacture, because in the almost solid masterbatch the CNTs are not mobile enough to reaggregate. This has been supported by repeated measurement of freshly thinned samples, where at all applied nanotube contents maximal particle sizes below 10 microns could be measured (which is the fineness of grind of the original masterbatch before thinning).

#### *Viscosity tests*

The viscosity tests have been performed at room temperature. The results of the viscosity tests can be seen in **Figure 1.4**.

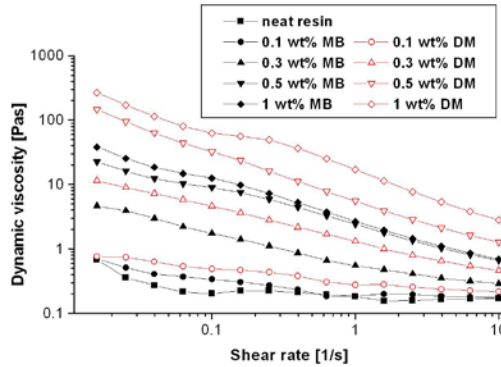

**Figure 1.4** Viscosity comparison of MWCNT filled epoxy resins prepared by the masterbatch technology and direct mixing

The viscosity values are in direct connection with the global dispersion state of the MWCNT reinforced system. From the results of the viscosity tests it can be clearly seen that the masterbatch technology provides not only lower maximum particle size, but also better global dispersion resulting in lower viscosity at all MWCNT contents. The more evenly dispersed, lower viscosity system is also more suitable for processing and part manufacture.

#### Mechanical tests

To characterize the effect of mixing method on the reinforcing potential of MWCNTs in composites mechanical tests have been carried out on cast specimens based on AH-12 – T-58 epoxy matrix loaded with MWCNTs dispersed by the two dispersion methods.

The **tensile tests** have been performed according to EN ISO 527-2 on EN ISO 3167 type B specimens at 1 mm/min crosshead speed using a Zwick Z020 tensile tester. The strain has been measured by a Messphysik ME-46 Full Image Videoextensometer with a gauge length of 50 mm. The results of the tensile tests can be seen in **Figure 1.5**.

5

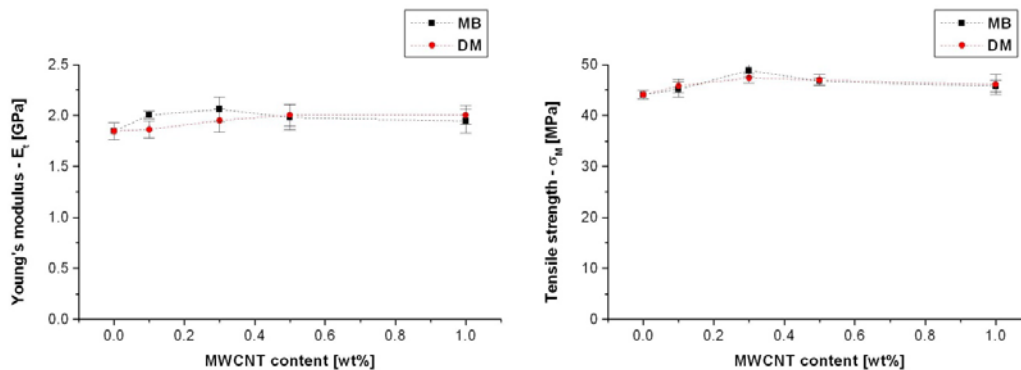

**Figure 1.5** Results of the tensile tests of MWCNT reinforced epoxy composites prepared by the masterbatch technology (MB) and direct mixing (DM)

The tensile test results showed no significant differences between the composites prepared by the two dispersion methods.

The **three point bending tests** have been performed according to EN ISO 178 using a Zwick Z020 computer controlled loading frame at 2 mm/min test speed and 64 mm support span. The results of the three point bending tests can be seen in **Figure 1.6**.

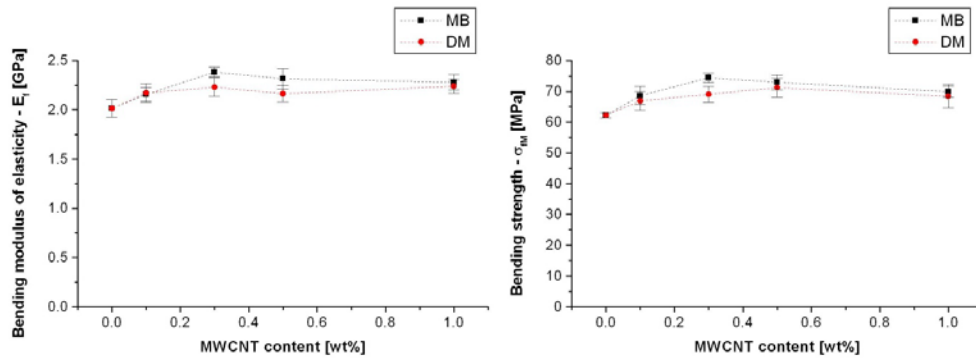

**Figure 1.6** Results of the three point bending tests of MWCNT reinforced epoxy composites prepared by the masterbatch technology (MB) and direct mixing (DM)

According to the three point bending test results the specimens prepared by the masterbatch technology were superior both in terms of modulus and strength to the ones prepared by direct mixing because of the better dispersion achieved.

The **notched Charpy impact tests** have been performed according to EN ISO 179-2 using a Ceast Resil Impactor Junior instrumented pendulum equipped with a 2 J hammer started from 150°C (2,9 m/s impact velocity). The data has been collected using a Ceast DAS 8000 data acquisition system. The notches have been machined using a Mutronic Diadisc cutter according to the type A notch of the standard. The results of the impact tests can be seen in **Figure 1.7**.

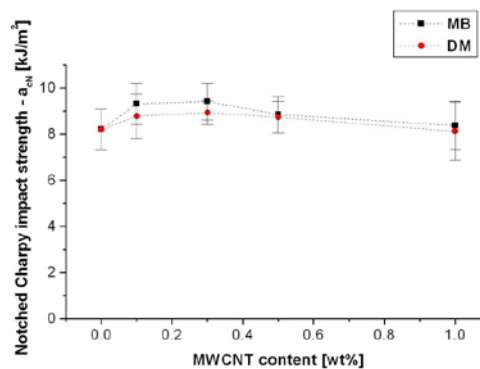

**Figure 1.7** Result of the notched Charpy impact tests of MWCNT reinforced epoxy composites prepared by the masterbatch technology (MB) and direct mixing (DM)

In the results of the notched Charpy impact tests also the better performance of the masterbatch technology prepared specimens can be observed, especially around the optimal MWCNT content of 0.3 wt%.

The results of the mechanical tests showed that the masterbatch technology is capable of the production of high performance nanocomposites, and that it provides higher mechanical properties than the competitor direct mixing technology, therefore the masterbatch technology has been selected for further use in the project.

#### *Transmission Electron Microscopy*

The dispersion achieved by the masterbatch technology has been investigated by TEM using a Morgani 268D TEM. The 80 nm thick samples have been cut using a Leica Ultramicrotome EMUC6 microtome from cast resin the AH-12 – T-111 matrix 0.3 wt% MWCNT reinforced cast specimens. Two typical TEM micrographs of the samples can be seen in **Figure 1.8**.

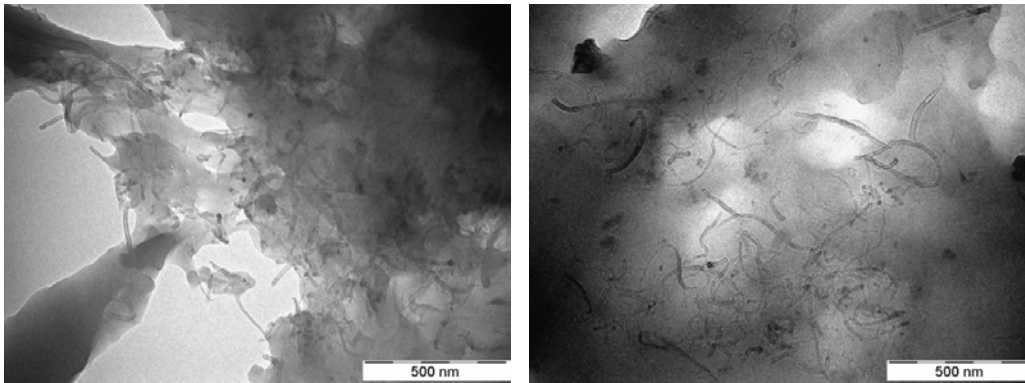

**Figure 1.8** TEM micrographs of 0.3 wt% MWCNT reinforced AH-12 – T-111 epoxy matrix specimens

In the TEM micrographs well distributed individual MWCNTs can be observed. This supports that the masterbatch technology has been successful in the dispersion of the MWCNTs in the epoxy resin.

### **Significant results:**

Two kinds of untreated MWCNTs have been characterized by SEM and AFM tests to investigate aggregate structure. Composites have been produced using the two MWCNT types as reinforcement for preliminary tensile, bending and notched Charpy impact tests. Based on the preliminary mechanical test results Bayer BT C150 HP MWCNTs have been selected for further use in the project. The characterization of four epoxy resins combined with six curing agents has been performed. Rheological characterization of the resins filled with multiple amounts of MWCNTs has been carried out. For further use the low viscosity AH-12 epoxy resin with T-111 curing agent has been chosen based on the mechanical and rheological performance compared to the conventional, high viscosity resin systems.

According to the results of the mechanical tests performed on MWCNT/CF reinforced hybrid composites prepared by vacuum bag technology (tensile, three point bending, interlaminar shear, DMA) 0.3 wt% MWCNT filling has been selected for further use in the project. The surface resistivity measurements performed on the specimens showed electrically conductive behaviour, which is also crucial for the success of the project.

The masterbatch dispersion method, developed for use with low viscosity resins has been characterized by rheological, particle size measurements and has been compared to a competitor direct mixing technology. The dispersion achieved by the used masterbatch technology has been characterized by TEM. According to the tests the masterbatch mixing technology is suitable for further use, provides good nanoparticle dispersion, without the risk of MWCNT reaggregation.

## **WP2 Development of polymer micro and nanofibres loaded with nanoparticles**

In the frame of WP2 electrospinning method was developed to produce polymer nano/microfibres loaded with CNTs, which serve as novel precursors for carbon fibres. Optimal heat treatment of PAN nanofibres was determined in order to get CNT-filled carbon nanofibres with improved electrical and thermal conductivity. Prepreg prototypes were made both from the produced PAN nanofabric and carbon fabric as reference. Laminate coupons were prepared for testing in WP3 (Thermal and electrical conductivity testing) and WP4 (Mechanical testing).

### **T2.1 Processes for polymer microfibers**

#### ***Selection of materials***

First of all, appropriate polymer and solvent combination for the electrospinning process, and nanotubes for the inclusion in nanofibres were selected, which meet the following strict requirements:



The material should be well-carbonizable and easy to process, meaning good fibre forming tendency and appropriate behaviour during the thermal treatments. The selected materials should not have had impurities as well. The world's carbon fibre manufacturing is about 90% based on **polyacrylonitrile (PAN)**, which was selected for processing nanofibres. The powder of PAN was used with **N,N-dimethylformamide (DMF)** as solvent (acquired from Aldrich). According to WP1, Baytubes C 150 HP (Bayer, Germany), **multiwalled carbon nanotube (MWCNT)** was selected.

### ***Development of electrospinning method for producing nanofibrous precursors and sample production***

Nowadays, there are many feasible ways to produce electrospun nanofibres via efficient and productive ways. One of the most common technologies is the free-surface electrospinning, and maybe the most popular is NanoSpider [O. Jirsák, F. Sanetnik, D. Lukas, V. Kotek, L. Martinova, J Chaloupek: A method of nanofibres production from a polymer solution using electrostatic spinning and a device for carrying out the method. U.S. W02005024101 (2005)] produced by Elmarco company.

The electrospinning setup can be seen in **Figure 2.1**. The voltage is supplied by a high voltage power supply. It is connected to a rotating metal electrode, which is in a reservoir filled with the solution. The rotating electrode takes the solution to its own surface. Taylor cones are formed on this open surface, then a thin jet emerges from every tip of these cones and electrospinning happens. The counter electrode is a flat metal sheet that is grounded. To ensure continuous production a substrate material, which is generally a nonwoven, is fixed to two rollers with an adjustable rotation speed. Therefore the electrospun samples have a continuous traction.

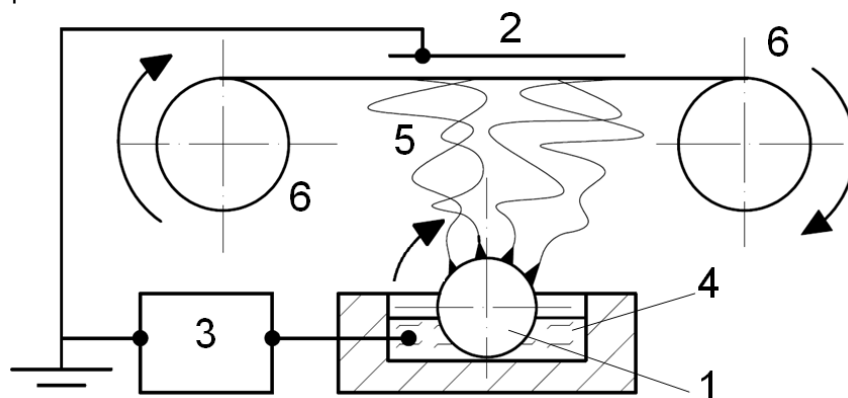

**Figure 2.1** Process for producing nanofibrous tapes by NanoSpider system 1: rotating electrode, 2: grounded electrode (collector), 3: high voltage power supply, 4: electrospinning solution, 5: ventilated fibre formation space, 6: rollers for continuous production

The applied NanoSpider had a rotating electrode with approx. 20 mm diameter and a length of 15 cm. The rotating electrode had a barbed construction in order to prevent Taylor-cone formation. The applied voltage was 55 kV. The reservoir had a volume of approx. 50 ml and rotation speed of the electrode was set to 20 rpm. The distance between the electrodes was 150 mm. The substrate was a roll of 50 cm wide nonwoven synthetic textile. The traction speed was set to 100 mm/min.

Optimal conditions for electrospinning were found to be 20°C temperature and 20% relative humidity. Under these conditions several meters of samples were created from all the three solutions (unloaded PAN, 1 and 2 wt% MWCNT PAN).

## **T2.2 Production of CNT filled polymer microfibers and graphitization**

### ***Development of CNT dispersion technique***

Dispersion of CNTs is a crucial issue, as they tend to form aggregates due to their high free surface energy. Our goal was to minimize the size of these aggregates.

The CNT dispersion method developed in the frame of WP2 consists of three consequent steps: dispersion of CNTs in a solvent, mixing with PAN, and finally a further dispersion step. The essence of our self-developed technique is to disperse CNTs in the solvent, then to mix with PAN followed by a further dispersion step. The results are summarized in **Figure 2.2**.

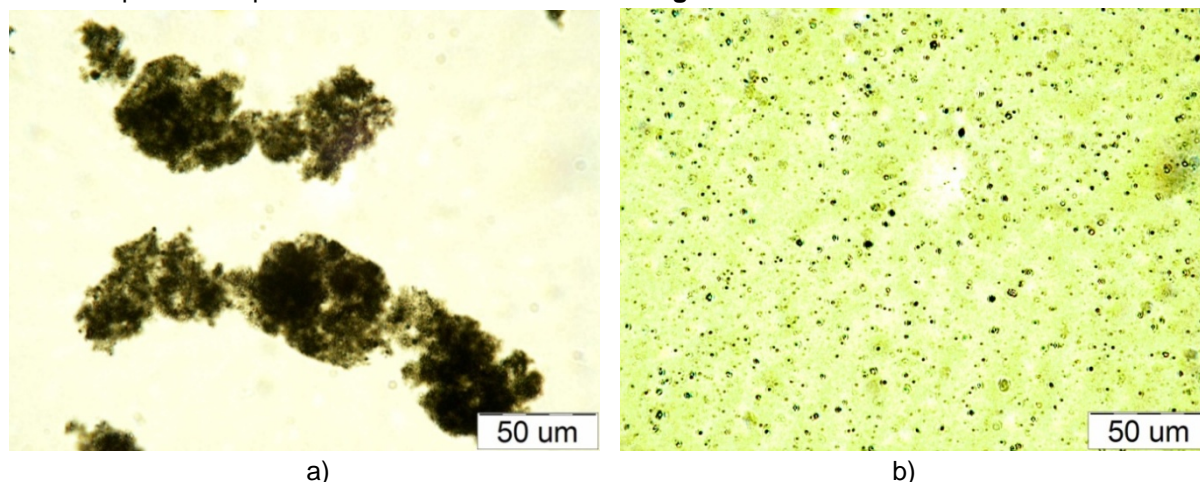

**Figure 2.2** Optical microscopic image of CNTs in PAN solutions. a) after pre-dispersion (step 1), b) after dispersion (step 3)

After dispersion the optimum solution viscosity was determined, and the different CNT contents were also taken into account. After optimizing the solutions fibres were electrospun in order to ensure proper fibre formation. Scanning electron micrographs (SEM) of the formed nanofibres are depicted in **Figure 2.3**.

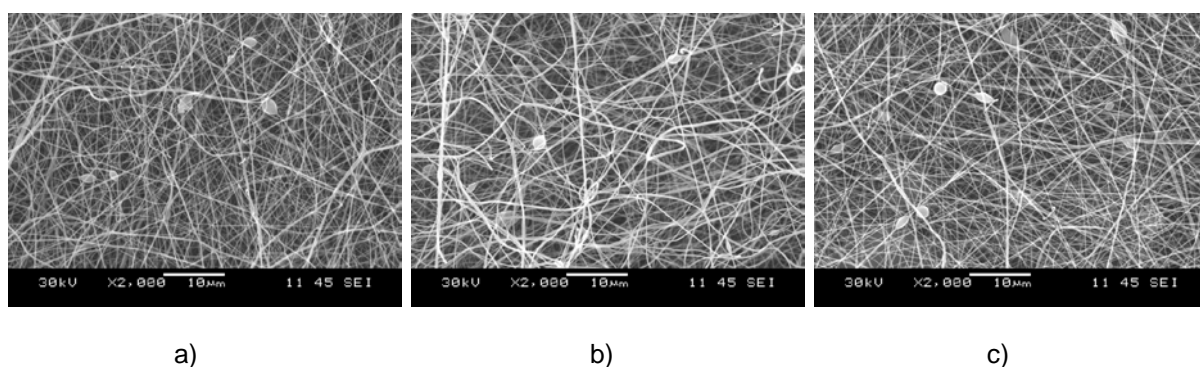

**Figure 2.3** SEM micrographs of electrospun PAN nanofibrous mats made from 11 wt%-concentrated PAN solutions. a) without CNT loading, b) 1 wt% CNT loading, c) 2wt% CNT loading

### ***Production of nanofibrous precursors by electrospinning method***

Samples from unloaded PAN, 1 and 2 wt% MWCNT PAN containing solutions were produced by the electrospinning method described in T2.1. With this method continuous nanofibre production nanofibrous mats were produced with desired thickness. The thickness of the samples was determined and is summarized in **Table 2.1**.

Based on these measurements the thickness of the layers before and after lamination as a function of the traction speed can be calculated and **the desired thickness can be set** in a wide range.

The formed nanofibres are white both in case of CNT-loaded and unloaded solutions, consequently CNTs do not modify the optical properties of nanofibres or the other possibility would be, that they are not at all present in the fibres. The presence of carbon nanotubes in the nanofibres can be confirmed by a simple experiment: when nanofibres are dissolved in DMF, their solution has a black colour

meaning that they contain CNTs as PAN solution itself has yellow colour, while addition of small amount of CNT to the solution results in black colour.

To confirm more exactly the presence of carbon nanotubes in the electrospun nanofibrous mats Raman spectrometry, Fourier transform infrared spectrometry (FTIR) and wide-angle X-ray diffraction (WAXD) were carried out. The **results clearly proved the presence of CNTs** within the formed nanofibrous structure.

**Table 2.1** Thickness of nanofibrous layers determined with different methods

	PAN nanofibre mat	PAN + 2m% CNT nanofibre mat
Thickness ,1 kPa pressure (ISO 5084:1996), [ $\mu\text{m}$ ]	$58.6 \pm 20.1$	$31.7 \pm 6.52$
Thickness (from compression test), [ $\mu\text{m}$ ]	$44.7 \pm 13.0$	$33.0 \pm 6.63$
Thickness embedded in resin [ $\mu\text{m}$ ]	N.A.	$23.5 \pm 1.35$
Compression modulus [kPa]	$28.7 \pm 3.1$	$26.7 \pm 3.2$

### **Optimization of the thermal treatment of polymer precursor fibres**

Nanofibres have different behaviour during pyrolysis compared to classical microfibrs. The reason is the principally different surface to mass ratio, as well as different fibre forming mechanisms, which can lead to different intrinsic molecular orientation and crystallinity.

To investigate and compare the behaviour of nano and microfibrs precursors, differential scanning calorimetry (DSC) and thermogravimetric analysis (TGA) were carried out. These methods provided a good opportunity to monitor the heat release and weight loss of samples under conditions simulating the real stabilization process with a small sample demand (few milligrams). Similarly to the real stabilization process, the temperature program included a linear ramp from room temperature up to a few hundred  $^{\circ}\text{C}$ , in air atmosphere. In some cases, measurements were also carried out in inert atmosphere (nitrogen) in order to acquire deeper knowledge and understanding on the chemical reactions.

Differential Scanning Calorimetry (DSC) measurements in nitrogen atmosphere revealed that CNTs are preferable from the point of stabilization. The application of CNTs not only decreased the cyclization temperatures, but also decreased the intensity, resulting in values closer to the value of microfibrs. It means that **CNTs helped to avoid degradation of fibres during pyrolysis**. The results are summarized in **Figure 2.4**.

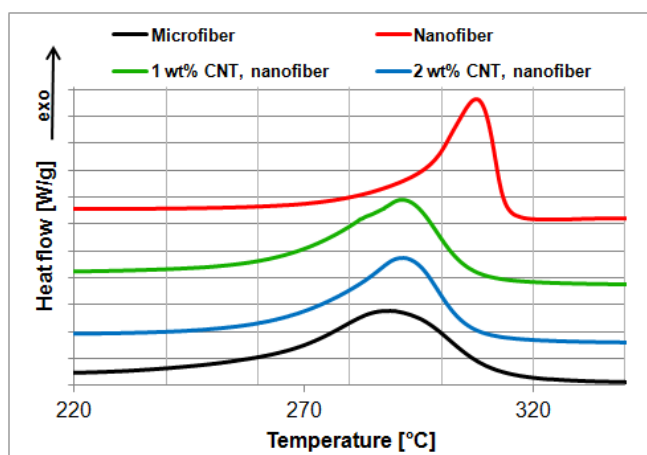
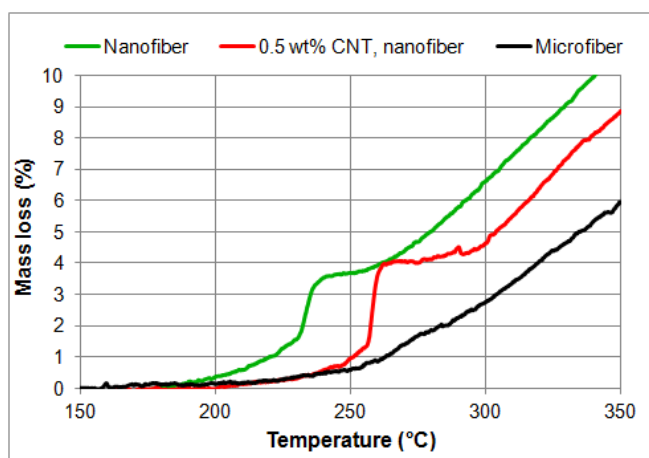

**Figure 2.4** DSC plot of different PAN nanofibres focused on cyclization

As stabilization of PAN precursors takes place in air atmosphere, DSC measurements were also carried out in air in order to get more information about the dehydrogenation and formation of different functional groups.

Nanofibres had 2.5 times higher stabilization energy compared to microfibrils, which is not favourable, but seems to be inherent with the high surface to mass ratio or lower crystallinity. There were no significant changes in total energy when adding nanotubes to nanofibres. From another viewpoint MWCNTs are favourable because they decrease the intensity of the first peak by 9% and 17% depending on their concentration, making the process more controllable. Stabilization of nanofibres is a big challenge compared to microfibrils, nevertheless the **results reveal that application of MWCNTs can lower the risks of degradation.**

Mass loss induced by temperature is a very important property of precursor fibres. To produce carbon fibres with excellent mechanical properties stabilization in air has to be carried out without degradation. The results are summarized in **Figure 2.5**.



**Figure 2.5** TGA curves focusing on the mass loss above 200°C

Focusing on the temperature region between 150 and 350°C, it was noticed that nanofibres suddenly lose weight around 250°C. By carrying out several measurements, it was found that the temperature, where this sudden mass loss occurs, cannot be determined exactly as it has a deviance. It usually happened randomly between 240°C and 260°C. If TGA and DSC measurements are compared it seems that some relationship exists between the sudden high peak of DSC plots and this drop in mass, which leads to a mass loss of approx. 3.5%.

Two options can be considered to avoid the possible degradation:

1. the stabilization could be carried under 240°C or
2. a stabilization program with low heating rate and with more temperature steps, but it represents more risks as nanofibres are more sensitive to degradation.

The 2 wt% CNT loaded PAN nanofibres were selected for further experiments and the unloaded sample was also applied as reference. Nanofibrous samples were heat treated at different temperatures in Nabertherm type laboratory furnace. The heating rate was 10°C/min below 200°C and 5°C/min above. Stripes of samples were wound to ceramic tubes in order to avoid shrinkage during stabilization. The heat treatments at constant temperature (after heating up) took 1 hour in case of each sample.

DSC, Raman spectroscopy and FTIR analysis of the samples were carried out. The results of DSC experiments on nanofibres can be seen in **Figure 2.6**.

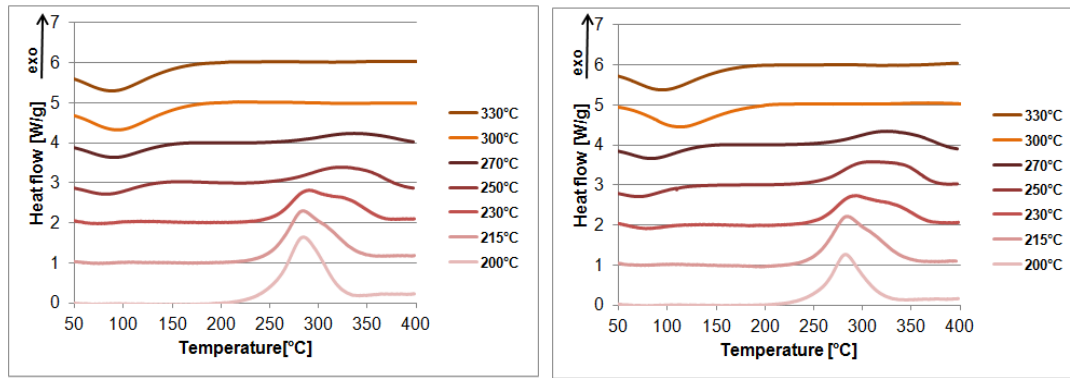

**Figure 2.6** DSC plots of PAN nanofibres after 1h treatment at different temperatures. a) PAN nanofibre, b) PAN nanofibre with 2 wt% MWCNT loading

By increasing the stabilization temperature, the exothermic peaks related to cyclization of the remaining nitrile side chains became smaller, which means that higher temperatures lead to more cyclized, and consequently more stable PAN. From the quotient of the exothermic heat of the untreated and of the stabilized samples even the conversion rate can be calculated. By increasing the temperature this conversion or stabilization rate became higher. This phenomenon was also confirmed by FTIR measurements. The conversion rates were determined as a function of heat treatment temperatures. WAXD experiments also revealed the conversion of PAN into a stabilized, ladder-polymer structure. By determining the adequate stabilization program the carbonization process could be determined.

DSC and TGA measurements revealed that below 240°C no sudden reactions occur. On the other hand, on the basis of FTIR and DSC measurements of the stabilized samples, it can be stated that higher temperatures are necessary to eliminate all the nitrile groups. As a consequence, stabilization could be performed in more steps. The first step could be carried out at 200°C or 215°C, followed by another one at 300°C. Heating rate is also a very important factor, it should be below 5°C/min in case of temperatures above 200°C to avoid degradation. A total stabilization time of 2x15 min is suggested, as nanofibres have large surface to gain the required heat exposure in their whole cross sections. The danger of the formation of core-shell structure is less than in case of microfibrils. Finally, stabilization of nanofibres should be carried out in air atmosphere, with adequate ventilation.

### **T2.3 Development of prepreg tapes and composites made thereof**

In the frame of T2.3 first, materials for prepreg production were selected, and after that prepreg tapes were made both from the carbon fabric and the PAN nanofabric. The laminate coupon manufacturing is scheduled for the second period of the project.

#### ***Selection of materials***

AH-12 aliphatic epoxy resin with T-111 hardener (ipox chemicals, Hungary; mixing weight ratio: 100:116) low viscosity prepreg system utilizing the extremely low viscosity epoxy resin with prepreg hardener has been used as matrix material. The system is capable of prepreg use, can be cured above 80°C.

Baytubes C 150 HP (Bayer, Germany), multiwalled carbon nanotubes were selected as nanosized reinforcement both dispersed in the matrix and embedded in the nanofibers.

Zoltek PX35FBUD0300 (Zoltek, Hungary) unidirectional carbon fabric was used as microsized reinforcement reference. The fabric consisted of Panex 35 50k rovings and had a surface weight of 309 g/m<sup>2</sup>.

PAN nanofibrous mat (described in deliverable **D2.2 Precursor evaluation and microfibrils production report**) was produced in the newly developed electrospinning device.

### **Production of prepreg tapes**

Firstly, the CNT-s have been dispersed in the epoxy matrix using the developed masterbatch (MB) mixing technology described in deliverable **D1.1 (Resin evaluation report)**. The CNT content of the matrix was 0.3 weight% based on the results of tests presented in D1.1. In the second step, the curing agent (T-111) has been mixed to the system using an overhead stirrer equipped with a turbine type impeller. The mixture has been poured into a flat vessel to form an impregnating bath.

The reinforcing material (the carbon fabric and the PAN nanofabric) has been cut to 130 mm width (matched to the vessel used for impregnation). For demonstration purposes a 210 mm long prototype has been manufactured, but there is basically no limitation in the length of the prepared prepreg, continuous manufacture is feasible. Because of the limitations of the experimental carbonization chamber currently used, the carbonized PAN sample size has been 30 x 60 mm, an industrial tunnel furnace is currently being installed for the upcoming specimen production.

In case of the production test, the reinforcing material has been weighed before impregnation for resin content calculation. The reinforcing material has been immersed into the resin bath for 1 minute. After this immersion time no further raise in weight could be measured, the reinforcing material could not take up more resin. The prepared impregnated reinforcing material has been placed between two polyethylene protector films. To remove excess resin, the prepreg has been rolled between two parallel rolls. After rolling each sample has been weighed to measure the remaining resin content of the prepregs.

The prepared prepreg prototypes show sufficient tack for effective layup, the achieved resin contents are also appropriate.

The prepared samples and the achieved resin contents are presented in **Table 2.2**.

**Table 2.2** The prepared prepreg prototypes

Sample no.	Matrix	Fiber reinforcement	Resin content (m/m%)
1	without CNTs	Zoltek PX35FBUD0300	49.7
2	0.3 wt% CNT content	Zoltek PX35FBUD0300	49.9
3	without CNTs	electrospun nanofibers without CNTs	94.0
4	0.3 wt% CNT content	electrospun nanofibers without CNTs	92.5
5	without CNTs	electrospun nanofibers with embedded CNTs	93.2
6	0.3 wt% CNT content	electrospun nanofibers with embedded CNTs	93.9
7	without CNTs	carbonized electrospun nanofibers without CNTs	93,5
8	0.3 wt% CNT content	carbonized electrospun nanofibers without CNTs	94.2
9	without CNTs	carbonized electrospun nanofibers with embedded CNTs	93.4
10	0.3 wt% CNT content	carbonized electrospun nanofibers with embedded CNTs	92.8

### **Production of composites**

The composites were prepared by **vacuum bag technology** thoroughly described in the D1 deliverable. For the composite preparation 8 layers of reinforcing material were used for the nanofiber reinforced samples (Figure 1), resulting in approximately 1.5 mm laminate thickness. In case of the microfiber reinforced references 3 unidirectional layers have been used, to match the thickness of the nanofiber reinforced samples. Each sample was cured in a Heraeus UT-20 oven at 80°C for 8 hours.

The specimens were cut from the laminates using a Mutronic Diadisc diamond disc cutter to the desired specimen size (30 mm x 200 mm for the four-pin electrical conductivity and the conducted

lightning tests, according to the ME-T-MM-120031 Memorandum, and 80x80 mm for the guarded hot plate tests).

During composite preparation the produced nanofibrous prepregs proved to be usable and adequately easy to handle.



**Figure 2.1** Composite preparation from the developed nanofibrous prepreg

### **Significant results**

The following conclusions were drawn as a result of the work carried out in the frame of WP2:

#### **Preparation of prepregs:**

Prepreg tapes were made both from the carbon fabric and the PAN nanofabric. The prepared prepreg prototypes show sufficient tack for effective layup, the achieved resin contents are also appropriate.

#### **Preparation of composites:**

During composite preparation the produced nanofibrous prepregs proved to be usable and adequately easy to handle.

### **WP3 Thermal and electrical conductivity testing**

Objective of WP3 was to characterize the thermal and electrical conductivity of the prepared laminate samples.

For the thermal and electrical conductivity tests four samples (unwoven carbon nanofabric reinforced MWCNT filled epoxy, unwoven carbon nanofabric reinforced epoxy, carbon fiber reinforced MWCNT filled epoxy and carbon fiber reinforced epoxy) have been prepared to characterize the effect of CNT filling and to be able to compare the developed nanofiber reinforced composites to the conventional microsized carbon fiber reinforced composites.

The thermal conductivity tests were performed in the guarded hot plate setup. The surface resistivity measurements were performed in the four-pin setup.

#### **T3.1 Thermal and electrical conductivity test**

The thermal conductivity tests were performed in the **guarded hot plate setup (Figure 3.1, Figure 3.2)**, where the sample is placed between two copper plates, one of them is heated to a given temperature at designated parameters, the temperatures of both plates, and the heating energy input are monitored and the thermal conductivity can be calculated. The plates and the sample are placed in an isolated chamber. The specimens have been covered with thermal conductive silicone grease to minimize thermal resistivity caused by the possible gap between the plates and the specimen.

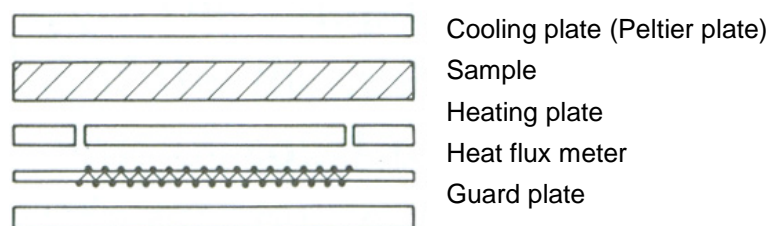

**Figure 3.1** The guarded hot plate test setup

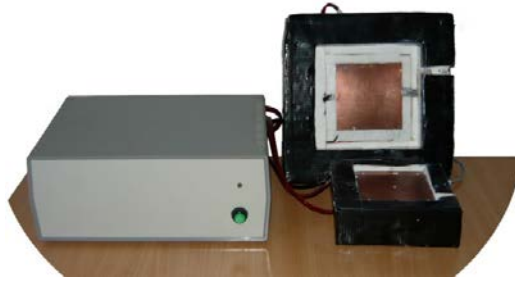

**Figure 3.2** The guarded hot plate device used for the measurements

The test results are presented in **Table 3.1**. The beneficial effect of MWCNT filling of the matrix is present at both the micro- and the nanofiber reinforced composite. The nanofiber reinforced composite proved to be less thermally conductive than the microfiber reinforced one. The thermal conductivity is measured perpendicular to the reinforcing materials. In case of the nanofibers there are probably much less thermal conductive fibers in that dimension, and the structure of the fibers suggests also lower thermal conductivity in the direction perpendicular to the fibers this can give an explanation to the lower thermal conductivity values. When comparing the samples with MWCNT loaded nanofibers and the unfilled nanofibers a significant difference is measurable. The higher thermal conductivity of the MWCNT containing nanofiber reinforced composites can be explained by the increased thermal conductivity of the fibers. The inclusion of MWCNTs in a PAN fiber can help the formation of a more perfect and aligned graphite structure in the carbonised fibers (the MWCNTs can act as a muster for the forming graphite layers besides them), leading to higher thermal conductivity.

**Table 3.1** Results of the guarded hot plate thermal conductivity tests

No.	Reinforcement	Matrix	Thermal conductivity (W/(m*K))
1	Carbonized, 2 weight% MWCNT loaded PAN nonwoven nanofabric (8 layers)	Epoxy + 0.3 weight% MWCNT	0.505
2	Carbonized, 2 weight% MWCNT loaded PAN nonwoven nanofabric (8 layers)	Epoxy	0.454
3	Carbonized PAN nonwoven nanofabric (8 layers)	Epoxy + 0.3 weight% MWCNT	0.146
4	Carbonized PAN nonwoven nanofabric (8 layers)	Epoxy	0.123
5	Unidirectional carbon weave (3 layers)	Epoxy + 0.3 weight% MWCNT	0.285
6	Unidirectional carbon weave (3 layers)	Epoxy	0.162

The conductivity of the plates has been measured using an Agilent 4338B Milliohmmeter in four pin test setup using a custom measuring head (**Figure 3.3**). The four gold plated electrodes have been installed in a row 2 cm apart from each other.

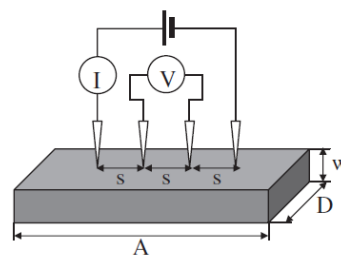
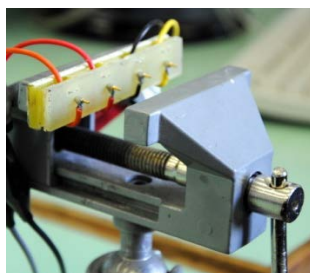

**Figure 3.3** Measuring head with the electrodes(left), theoretical test setup (right)



The results of the four pin resistivity tests are presented in **Table 3.2**. The beneficial effect of MWCNT filling of the matrix of the composite is also present in this case. An interesting **synergistic effect** appeared in the electric conductivity values. While without MWCNTs the nanofiber reinforced composites showed the lowest electric conductivity, with MWCNTs added to the matrix the electrical conductivity values became the highest. This can be caused by **percolation reached** with the addition of the MWCNTs. It is also worth to notice, that the addition of the MWCNTs caused the highest increase in case of the nanofiber reinforced composites, indicating that they can link to them much better than to the carbon fibers. When comparing the samples with MWCNT loaded nanofibers and the unfilled nanofibers a difference of multiple orders of magnitude is measurable. The higher electrical conductivity of the MWCNT containing nanofiber reinforced composites can be explained by the increased thermal conductivity of the fibers. This can be caused by two effects. One is the percolation of the MWCNTs inside the fibers providing an electrically conductive network. The other effect is, that the inclusion of MWCNTs in a PAN fiber can help the formation of a more perfect and aligned graphite structure in the carbonised fibers (the MWCNTs can act as a muster for the forming graphite layers besides them), leading to higher electrical conductivity.

**Table 3.2** Results of the four-pin electric conductivity tests

No.	Reinforcement	Matrix	Fiber orientation	Specific resistivity (Ohm*cm)	Electric conductivity (S/cm)
1	Carbonized, 2 weight% MWCNT loaded PAN nonwoven nanofabric (8 layers)	Epoxy + 0.3 weight% MWCNT	not available	2.08	0.4799
2	Carbonized, 2 weight% MWCNT loaded PAN nonwoven nanofabric (8 layers)	Epoxy	not available	23.40	0.0427
3	Carbonized PAN nonwoven nanofabric (8 layers)	Epoxy + 0.3 weight% MWCNT	not available	15177	6.86*10-05
4	Carbonized PAN nonwoven nanofabric (8 layers)	Epoxy	not available	461577	2.25*10-06
5	Unidirectional carbon weave (3 layers)	Epoxy + 0.3 weight% MWCNT Epoxy	parallel	2.53	0.3955
			perpendicular	3.15	0.3176
6	Unidirectional carbon weave (3 layers)	Epoxy	parallel	11.13	0.0898
			perpendicular	16.41	0.0609

**Significant results:**

Scientific results:

The thermal and electrical conductivity measurements of the composites provided promising results. The thermal conductivity of the samples has increased by approximately 3 times with the inclusion of MWCNTs in the carbonised nanofibers. The thermal conductivity of the carbonised nanofiber reinforced composites is almost twice the thermal conductivity of the composites with standard carbon fibers. The electrical conductivity is 20% or 50% better in case of MWCNT containing carbonised nanofiber reinforced composites compared to the electrical conductivity measured parallel or perpendicular to fiber orientation of carbon fiber reinforced composites. The results also showed that the inclusion of MWCNTs in the PAN precursor fibers is essential for the formation of conductive (both

thermally and electrically) carbonised nanofibers by the mediation of the formation of a more perfect and aligned graphite structure.

#### WP4: Mechanical evaluation

The objective of WP4 is to evaluate the mechanical properties of the prepared laminates.

To be able to compare the developed carbonized nanofiber reinforced composites to the conventional carbon fiber reinforced composites, and to characterize the effect of MWCNT loading of the matrix of the composites, six samples were prepared using three types of reinforcing materials (carbonized unwoven PAN nanofabric, carbonized unwoven MWCNT filled PAN nanofabric, conventional carbon fiber) with epoxy and MWCNT filled epoxy matrix.

The mechanical properties of the composites have been compared through tensile, three point bending, and notched Charpy impact tests.

#### T4.1 Mechanical testing

The **tensile tests** were performed according to EN ISO 527-2 on 80 mm long, and 10 mm wide specimens using a Zwick Z005 computer controlled tensile tester with self-aligning grips at 1 mm/min test speed and a gauge length of 40 mm. The results of the tensile tests are presented in **Table 4.1**.

**Table 4.1** Results of the tensile tests

No.	Reinforcement	Matrix	Tensile strength [MPa]	Young's Modulus [GPa]
1	Carbonized, 2 weight% MWCNT loaded PAN nonwoven nanofabric (8 layers)	Epoxy + 0.3 weight% MWCNT	45.29±6.91	2.77±0.17
2	Carbonized, 2 weight% MWCNT loaded PAN nonwoven nanofabric (8 layers)	Epoxy	51.16±1.47	2.46±0.12
3	Carbonized PAN nonwoven nanofabric (8 layers)	Epoxy + 0.3 weight% MWCNT	50.84±5.06	2.14±0.16
4	Carbonized PAN nonwoven nanofabric (8 layers)	Epoxy	42.73±5.79	1.47±0.15
5	Unidirectional carbon weave (3 layers)	Epoxy + 0.3 weight% MWCNT	422.79±58.40	18.89±0.72
6	Unidirectional carbon weave (3 layers)	Epoxy	414.93±69.13	20.66±2.62

The results of the tensile tests showed mixed results. The superiority of the conventional carbon fiber reinforced composites is evident. Both the Young's moduli and the tensile strength values of the carbon fiber reinforced composites are one order of magnitude higher than the carbonized nanofiber reinforced composites'. The MWCNT filling of the matrix caused increase in the Young's moduli of the nanofiber reinforced samples, where the influence of the matrix is more dominant than in case of the microfiber reinforced composites. The MWCNT filling of the carbonized PAN nanofibers caused an increase of the moduli of the composites, showing that the fibers become stiffer when MWCNTs are integrated into them presumably by the more aligned structure of the graphite layers.

The **three point bending tests** were performed according to EN ISO 178 on 80 mm long, and 10 mm wide specimens using a Zwick Z005 computer controlled tensile tester with a standard three point bending fixture at 1 mm/min test speed and a support span of 32 mm. The results of the three point bending tests are presented in Table 4.2.

**Table 4.2** Results of the three point bending tests

No.	Reinforcement	Matrix	Flexural strength [MPa]	Flexural Modulus [MPa]
1	Carbonized, 2 weight% MWCNT loaded PAN nonwoven nanofabric (8 layers)	Epoxy + 0.3 weight% MWCNT	78.26±4.66	3973.37 ±438.40
2	Carbonized, 2 weight% MWCNT loaded PAN nonwoven nanofabric (8 layers)	Epoxy	68.59±0.73	3867.96 ±28.90
3	Carbonized PAN nonwoven nanofabric (8 layers)	Epoxy + 0.3 weight% MWCNT	70.34±4.71	2992.68 ±168.97
4	Carbonized PAN nonwoven nanofabric (8 layers)	Epoxy	51.68±13.53	1889.05 ±135.61
5	Unidirectional carbon weave (3 layers)	Epoxy + 0.3 weight% MWCNT	813.73±99.78	44843.8641 ±903.2500
6	Unidirectional carbon weave (3 layers)	Epoxy	895.50±94.93	41957.61 ±877.23

In terms of flexural modulus and strength the superiority of carbon fiber reinforcement is also clear. While in case of the conventional fiber reinforced composites the MWCNT filling of the matrix caused no significant effect, in case of the nanofiber reinforced composites the MWCNT filling of the matrix has slightly improved the flexural strength and significantly improved the modulus values, especially when no MWCNTs were present in the carbonized nanofibers. The higher increases are because of the weaker fibers – the effect of the matrix properties is more dominant in this case. The difference between the MWCNT containing and unfilled carbonized PAN nanofibers is also more pronounced in the bending properties. The increased fiber stiffness caused by the embedded MWCNTs leads to the increased stiffness of the whole structure of the composite.

The **Charpy notched impact tests** were performed according to EN ISO 179 on 80 mm long, and 10 mm wide specimens with a machined, 2 mm deep standard notch (type A) in the center using a Ceast Resil Impactor Junior instrumented pendulum equipped with a 2 J hammer with an impact speed of 2.9 m/s and a support span of 42 mm in instrumented configuration. The force-time curves were registered by a Ceast DAS 8000 data acquisition unit. The results of the instrumented Charpy notched impact tests are presented **Table 4.3**. The Charpy notched impact tests showed interesting results, while the impact resistance of samples 1-3 were poor compared to the conventional fiber reinforced composites, the Charpy notched impact strength of the carbonized PAN reinforced MWCNT filled matrix composite almost reached the values of the conventional carbon fiber reinforced composites. This can be caused by two effects. The first effect is the relatively ductile fiber, containing no MWCNTs. While the relative flexibility of the fibers was a weakness in static properties, when coming to impact resistance, it has increased the energy absorbing capability significantly. The second effect was the ductility increasing effect of the MWCNT filling: the embedded MWCNTs force the crack to propagate along a longer path through the cross-section of the composite, increasing the energy absorbed in the fracture process. The synergy of these two effects caused the excellence of sample 4.

**Table 4.3** Results of the Charpy notched impact tests

No.	Reinforcement	Matrix	Charpy notched impact strength [MPa]
1	Carbonized, 2 weight% MWCNT loaded PAN nonwoven nanofabric (8 layers)	Epoxy + 0.3 weight% MWCNT	26.43±12.00
2	Carbonized, 2 weight% MWCNT loaded PAN nonwoven nanofabric (8 layers)	Epoxy	23.70±4.88
3	Carbonized PAN nonwoven nanofabric (8 layers)	Epoxy + 0.3 weight% MWCNT	19.73±6.61
4	Carbonized PAN nonwoven nanofabric (8 layers)	Epoxy	54.93±11.50
5	Unidirectional carbon weave (3 layers)	Epoxy + 0.3 weight% MWCNT	72.89± 25.56
6	Unidirectional carbon weave (3 layers)	Epoxy	72.81±23.68

**Significant results:**

According to the results of the performed mechanical tests the following conclusions can be declared: The carbonized PAN reinforced composites have approximately one order of magnitude lower mechanical properties than the composites reinforced with conventional carbon fibers.

The MWCNT filling of the matrix has beneficial effects on almost all mechanical properties of the carbonized nanofiber reinforced composites, because the effect of matrix properties is more pronounced.

The MWCNT filling of the carbonized PAN nanofibers is beneficial in case of static properties causing significant stiffening of the fibers and the composites. The structure of the fibers has to be compared, the stiffening of the fibers is probably caused by the more aligned layers, and more uniform structure of the MWCNT filled carbonized PAN nanofibers. The formation of the graphite layers and the structure is supported by the MWCNTs in the matrix, leading to a more arranged structure and thereby better mechanical performance.

**WP5: Industrialization studies**

The aim of WP5 was to demonstrate the industrial applicability of the results gained in the previous WPs. A possible way to set up the production line of precursor tapes, their stabilization and carbonization was proposed. A new spinneret system was developed and patented, which allows formation of nanofibers with high throughput. In case of industrial-scale production some of the results of former WPs can be applied directly, but some others only with caution. The technologies and their parameters for industrial-scale production were determined.

**T5.1 Industrialization studies**

As for the **applied materials**, both the epoxy resins, carbon nanotubes and PAN used during the lab-scale experiments are suitable for industrial scale production; however the production parameters can be also adapted to other commercially available base materials by performing the necessary tests. The requirements are detailed in deliverable **D5.5 (Industrialization report)**

Concerning the **CNT dispersion technique** in epoxy resins, the applied **three-step masterbatch technique** is already a semi-industrial method, which can be easily scaled up to industrial scale, by using larger capacity industrial overhead stirrers and three roll mills. The dispersion of CNTs in PAN is suggested to be carried out in three consequent steps: short ultrasonic dispersion of CNTs in a solvent, mixing with PAN with three roll mill, and a further short ultrasonic dispersion step.

**Nanofibers** can be produced in a continuous mat format using Nanospider technology. Nanospider is a commercially available system, easy to be used for PAN nanofiber formation. To increase the productivity, more than one spinnerets can be used in line. The applied voltage was 55 kV, the electrode speed was 20 rpm and the distance between the electrodes was 150 mm. The applied traction speed in the experiments was 100 mm/min, but it should meet the required mat thickness. Mat thickness is inversely proportional to the traction speed. In case of industrial scale production (see **Figure 5.1**) some considerations should be taken into account.

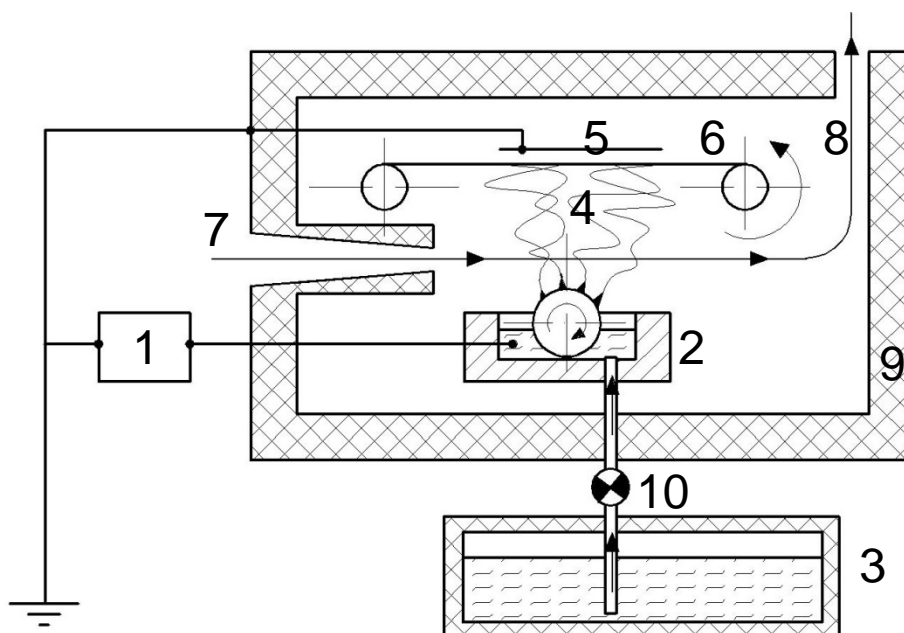

**Figure 5.1** Industrial-scale nanofiber precursor production. 1: high voltage power supply, 2: spinneret for high throughput production, 3: solution reservoir, 4: ventilated fiber formation space, 5: collector electrode, 6: nanofiber collecting belt with traction, 7: air inlet, 8: air and solvent removal and regeneration. 9: isolated enclosing, 10: solution feed pump

The removal of the solvent from the electrospinning chamber is necessary because enrichment of solvent in the electrospinning space can block fiber formation. The electrospinning should be carried out in an isolated chamber to avoid inhalation of DMF and to avoid the hazard of electric shock. The ventilation of the chamber is recommended and the exhausted mixture of air and DMF should be possibly post-treated in order to re-generate DMF. If orientation of the fibers is required, an air flow with a speed of 0.1-5 m/s could be applied in order to orient the deposition of nanofibers.

Other **electrospinning systems** can be also applied. Capillary electrospinning was tested and resulted same fiber diameters, therefore the multi-capillary arrangements can be also recommended. During the project **another spinneret system was developed and patented** (K. Molnar, Zs.K. Nagy, L. Meszaros, Gy. Marosi. High output spinneret and method for producing nanofibers. HU – No. 1200677/1). **Figure 5.2** shows the rotating spinneret. The technology allows formation of nanofibers with a high throughput. Nanofiber morphology was also found to be the same, therefore it can be also utilized, although it is not yet commercially available.

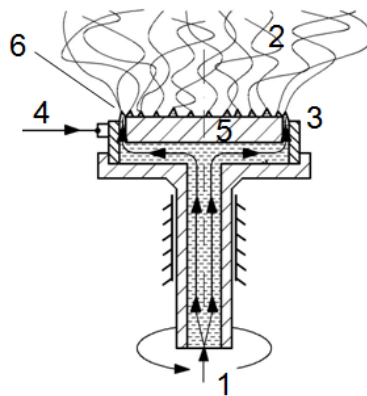

**Figure 5.2** Rotating spinneret for high throughput nanofiber formation. 1: solution inlet, 2: fiber formation space, 3: round-shaped metal electrode, 4: high voltage connector, 5: covering, 6: gap between the covering and the metal high voltage electrode

One possible way to set up the production line can be seen as a schematic in **Figure 5.3**.

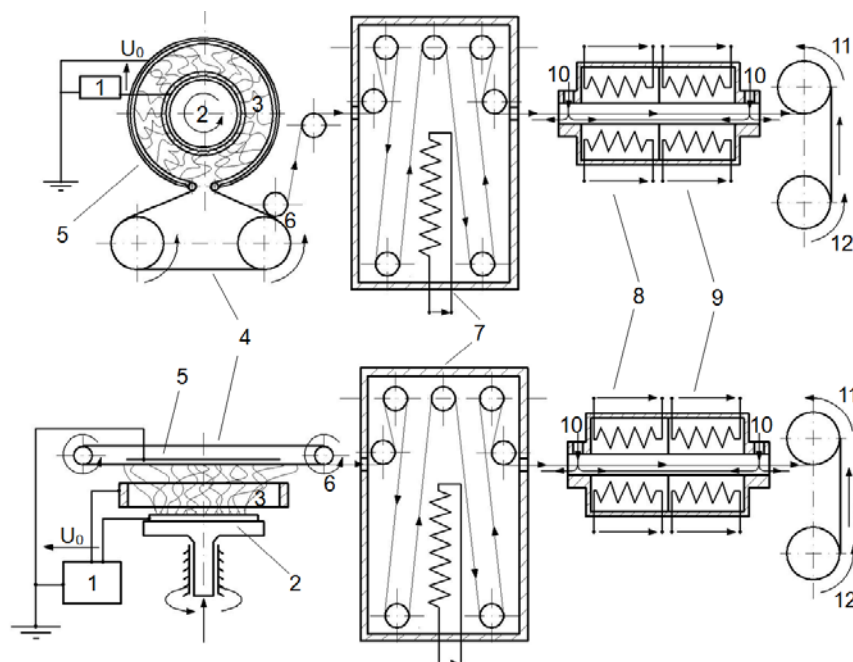

**Figure 5.3** Possible manufacturing line of electrospun PAN-based carbon nanofibers. 1: high voltage power supply, 2: spinneret, 3: fiber formation space, 4: moving belt collecting precursor fibers, 5: collector electrode, 6: traction and removal of nanofibers from belt, 7: stabilization oven (drawing of fibers and stabilization), 8: oven for low temperature carbonization, 9: oven for high temperature carbonization, 10: gas inlets, 11: winding, 12: covering with release foil, or carbon fibers etc.

After precursor production (1-5) the nanofibrous precursor should be removed from the collecting belt (6). At this point the edges of the electrospun material should be continuously cut to ensure homogenous thickness of the tape along the width. The edges to be cut are about 5 cm with at both sides depending on precursor formation technology. The waste nanofibers can be re-solved in DMF and applied again in electrospinning.

**Stabilization and post-drawing** continuously takes place in an oven (7). Drawing should be carried out above  $T_g$  and below the initiation temperature of stabilization, between about 110 to 180°C, 150°C is recommended.

The suggested zones for stabilization are 220°C, 250°C for 5 minutes each, followed by the final stabilization at 265°C for 10 minutes. Drawing can be applied between rollers having different speed of with gently applied friction.

The tape thereafter would be **carbonized** in a tunnel furnace (8-10). Carbonization is suggested to be carried out at 800°C for 5 minutes, followed by high temperature carbonization between 1500°C to 3000°C, the higher the better.

After carbonization the carbon nanofibers should be rolled and covered with (for example polyethylene) foil to avoid damage of the structure before application (11-12). At this point instead of the release foil nanofibers can be also placed between carbon fabrics and hybrid structures can be formed during prepreg formation.

**Pre-pregs** can be made of the produced carbon nanofibers by using low viscosity epoxy resin by any of the most common pre-pregging technologies, such as direct and indirect fiber coating technologies. The resin content can be set with the distance of the heated calender rolls. As carbon nanofibers can be sensitive to mechanical shear forces, high resin content can only be realized when the reinforcement has a thickness of at least 100 µm. The other important thing that should be taken into account is that nanofibers are very porous and form a loose structure that means it can easily be compressed in transverse direction. By putting the pre-pregging rollers closer would modify not just resin content, but also the thickness of the reinforcement. For good impregnation, no special provisions are necessary as nanofibrous structure is quite porous and the wetting of the fibers by the resin is excellent.

After producing a wide roll of prepreg, it can be cut to less-wide rolls for compatibility with the part manufacturing technologies. For cutting the big roll in the cross direction, sharp blades, special saw with small teeth, laser or waterjet cutting can be applied. The suggested width of final tape can be between 2 mm to 50 mm depending on application technique. The rolls of carbon nanofibers can be produced in almost any length, depending on the application.

In case of using ATL (automated tape laying) machine the inner diameter of roll should be compatible (76 mm) as well as the width of prepreg roll. It is suggested to also adjust the outer diameter of the roll to the ones applied currently. The prepreg thickness can also be the same, but can be produced even in thinner layers. Same kinds of polyethylene and silicone foils can be used as release.

The prepregs should be stored in a cold and dry place according to the recommendation of the resin manufacturer.

### **Significant results:**

#### Scientific results:

In WP5 the possible ways of industrialization are detailed. The main scientific results include guidelines for applications of material different from the ones applied in the project, an advanced thermal treatment program, a self-developed industrial production line and suggestions for pre-pregging and application of the developed materials.

Other scientific result is that a novel electrospinning system was developed and patented. This system allows producing nanofibers with a high throughput and as all carbon nanotubes are flowing with the polymer solution during electrospinning therefore composite nanofibers with arbitrary carbon nanotube content can be produced.

The results demonstrate that nanofibers require less time for stabilization than microfibers of the same material. Stabilization and carbonization therefore can economically be implemented.

Drawing should be carried out above  $T_g$  and below the initiation temperature of stabilization, between about 110 to 180°C, at 150°C recommended. The suggested zones for stabilization are 220°C, 250°C for 5 minutes each, followed by the final stabilization at 265°C for 10 minutes. Drawing can be applied between rollers having different speed of with gently applied friction. The tape thereafter would be carbonized in a tunnel furnace. Carbonization is suggested to be carried out at 800°C for 5 minutes, followed by high temperature carbonization between 1500°C to 3000°C, the higher the better.

#### 4. The potential impact (including the socio-economic impact and the wider societal implications of the project so far) and the main dissemination activities and exploitation of results

##### Description of the potential impact (including the socio-economic impact and the wider societal implications of the project so far)

The final outcome of the project is a **multi-hybrid composite material**, as the epoxy resin matrix is reinforced with carbon nanofibres, furthermore both the matrix and nanofibres are further reinforced with MWCNTs. Significant results were obtained both in the field of **mixing MWCNTs into the epoxy resins** and in the **production of MWCNT reinforced nanofibres, their stabilization and carbonization**. These results are not limited to the materials applied in the project, other materials can be used as well, as the production parameters can be adapted to other commercially available base materials by performing the necessary tests. The requirements are detailed in deliverable **D5.5 (Industrialization report)**.

The Baytubes BT C 150 HP MWCNTs selected for further use in the project proved to be effective nanosized composite reinforcing materials suitable for industrial applications. The reinforcing effect in case of both composites (epoxy matrix reinforced with MWCNTs) and hybrid composites (epoxy matrix reinforced with MWCNTs and conventional carbon fibers) looks promising. The **mechanical properties increased significantly**, also in case of the critical interlaminar and dynamic loading conditions. With the use of these nanofillers, tougher, more reliable materials can be produced at almost no increase in part weight (only low filler content is necessary). According the electrical conductivity tests, not only mechanical properties but also **electrical conductivity is improved** by the addition of the nanotubes. The produced composites showed conductive behaviour, which is useful in case of a lightning strike of an airplane hull or the placement of a simple grounding point on a composite cover panel of an electrical device or other applications where antistatic/conductive properties are necessary (agriculture, grain an powder storage, transportation).

The developed **masterbatch mixing method** proved to be effective in the dispersion of MWCNTs to epoxy matrices. The main advantages of the method are: **easy upscalability** (the main dispersion step is provided by a three roll mill, which is already available in industrial size), the **easy integration into present processes, the elimination of reaggregation** when the masterbatch has to be stored for a long time before thinning, and last but not least the **decrease of health risks** of the composite manufacturers because of the formed epoxy capsule around the MWCNTs which hinders them to become airborne. The masterbatch mixing technology can enable polymer composite raw material providers to easily produce ready to use MWCNT containing epoxy resin systems as masterbatches for the composite manufacturers. Also a great advantage is that the **masterbatch technology can be divided into two sections**. The first section ending with the **three roll milling**, with a necessary high cost three roll milled can be performed at the material provider where a large amount of masterbatch can be produced and provided to the end users. The second section, **the thinning of the masterbatch can be performed at the end user**, where only an overhead stirrer (already present at most end users for the mixing of the hardener and other additives and hardener to the resin) is needed. Also the transportation of the masterbatch **reduces environmental risks**, because in case of the accident the solid masterbatch does not spill like the resins, so pollution and the decontamination costs can be minimized.



In case of **nanofibre production** a technique that provides good dispersion of MWCNTs in the solutions was developed. The technique combines **mechanical mixing and ultrasonic treatment**. MWCNTs are therefore embedded within the nanofibrous structure and their presence improves several properties of nanofibers. **Polyacrylonitrile (PAN) nanofibers with MWCNT loading** can have a diameter of only 200 nm which shrinks to **110 nm** during pyrolysis.

Although, the mechanical properties of the produced nanofibers do not reach yet the mechanical properties of high strength carbon microfibers, and currently their production has moderate output rate, they could have numerous benefits in the field of composite technology. Namely, the **carbonization process is faster and therefore more cost-effective** compared to the production classical carbon fibres. By increasing their production rate, nanofibers are promising candidates to become a real industrialized reinforcement of composite materials. Furthermore, **carbon nanofibers are very flexible and have a very high surface area** compared to their mass, which can lead to a **good adhesion between the matrix and the fibres**. They could be applied in **hybrid composites**, e.g. they can be placed between microfibrillar layers (interleaved hybrid composites) or they can be well-applied in composite parts which have small curvatures. Application a carbon nanofibrous layers on the top and the bottom of these interleaved hybrid composites may **reduce the flammability** of the composites as well, which is crucial both in transport and electrical application areas. The produced carbon nanotube loaded carbon nanofibers have **very good electrical conductivity**, therefore in addition to the predicted various electric and sensor applications, they could be even applied as outer layers covering classical tape-reinforcements to carry electric charges in airframes. DSC, FTIR results and tensile tests all reveal that it is **advantageous to embed CNTs into fibres** because of **their positive effect both on stabilization and mechanical properties**. By inclusion of CNTs not only fibres with **higher modulus and tensile properties** could be possibly manufactured, but it would also **lower the risks of degradation during stabilization**, leading to a more economic and controllable production.

**MWCNTs** take part in the carbonization process as **they improve the graphitic structure of carbon nanofibres** and also **help to avoid degradation during stabilization**. The stabilization and carbonization of nanofibres can be carried out similarly to that of the microfibers. The nanofibres' higher surface to mass ratio should be taken into account during stabilization and carbonization. It is important to control the stabilization process as nanofibers are more sensitive to thermal-induced degradation than the microfibres of the same material. The experiences gained in the project can be applied at carbonization of other, PAN-based nanofibre precursor materials.

The developed techniques can easily be applied in industrial scales. Both **nanofibre production and carbonization** as well as **pre-pregging** can be implemented in a **continuous** and efficient way. A **novel nanofiber production system** that makes industrial production available is also introduced. The nanofiber reinforced prepregs can easily be applied in composites as their format and size can be **compatible with the automated tape layer robots**. With the widely-adjustable processing conditions nanofibre reinforced prepreg tapes can gain a high interest in the near future.

## **Main dissemination activities:**

### Participation in the education:

BSc, MSc and PhD students of Budapest University of Technology and Economics were/are involved in the research work carried out in the frame of the project. In the second reporting period the following theses were/are prepared:

- Gábor Szebényi: Development of fiber and nanoparticle reinforced hybrid composites (PhD thesis)
- Kolos Molnár: Electrospun nanofibrous structures and their composites (PhD thesis, 2013)
- Károly Nervetti: Development of carbon fiber reinforced hybrid prepregs for aerospace applications (MSc thesis)
- Péter Niedermann: The effect of carbon nanotube filling on the interlaminar fatigue properties of carbon fiber reinforced epoxy laminate (MSc thesis)
- Zoltán Cziráki: Analysis of mechanical properties of CNT reinforced hybrid composites applicable in aircraft industry (MSc thesis)
- Marcell Jankovics: Production and analysis of carbon nanofibres and their composites (MSc thesis)
- Katalin Karajz: Carbonization and evaluation of electrospun polyacrylonitrile nanofibers (MSc thesis)
- Péter Sas: Electrospun nanofibrous structures and optimization of the process (MSc thesis)
- Zoltán Cziráki: Development of carbon nanotube/carbon fiber reinforced epoxy matrix prepreg for aerospace applications (BSc thesis)
- Levente Ferenc Tóth: Development carbon fiber/carbon nanotubes/carbon nanofiber reinforced hybrid composites for aeronautical applications (BSc thesis)
- Imre Turi: Analysis of fatigue properties of carbon nanotubes/carbon nanofiber reinforced hybrid composites (BSc thesis)
- Ákos Belovay: Development of nanofiber toughened hybrid composites (BSc thesis)
- Tamás István Kovács: Optimization of electrospinning process for PAN nanofiber production. (Students' Scientific Conference at BME, 1<sup>st</sup> prize)

The knowledge acquired during the project was also disseminated in the frame of relevant laboratory practices and lectures.

Participation at exhibition:

Oral presentation and demonstration of the electrospinning method was given by Kolos Molnár at INDUSTRIAUTOMATION, International Industrial and Automation Trade Exhibition, Budapest, Hungary, 15-18 May 2012.



Radio broadcasts:

The project was disseminated in the following media within the framework of their scientific programs. The project and its results were detailed by Kolos Molnár in:

- MR2-Kossuth Radio (Hungarian National Radio: national and transboundary broadcast, in Hungarian), June 2012.
- Klub Radio (Regional Radio, Budapest: regional and internet broadcast, in Hungarian), August 2012

Brochure:

The project will be presented in the brochure on Hungarian aerospace R&D potential prepared by Hungarian Investment and Trade Agency (HITA) (2013, finalization of the brochure in progress).

Participation at conferences:

Oral/poster presentations were presented at following conferences:

- PRECARB-12, Surface Chemistry and Performance of Carbon Materials, Budapest, Hungary, June 2012
- Nanofibers 2012, Tokyo, Japan, June 2012
- 15th European Conference on Composite Materials, Venice, Italy, June 2012
- 7th International Conference on Modification, Degradation and Stability, Prague, Czech Republic, September 2012

Oral presentations:

- A. Toldy, B. Szolnoki, G. Szabenyi, Development of MWCNT/carbon fiber reinforced composite for aerospace applications, 15th European Conference on Composite Materials, Venice, Italy, June 2012
- B. Szolnoki, A. Toldy, P. Konrad, G. Szabenyi, Gy. Marosi, Comparison of additive and reactive phosphorus-based flame retardants in carbon fibre reinforced epoxy resin composites, 15th European Conference on Composite Materials, Venice, Italy, June 2012
- V. Quero Lopez, F. Sequeiros Murciano, F. Cano Perez, K. Molnar, Research activities on nano-materials and electromagnetic protection of composite aeronautical structures, 15th European Conference on Composite Materials, Venice, Italy, June 2012
- K. Molnar, Development of carbon nanofiber reinforced hybrid composites for aerospace applications, PRECARB-12, Surface Chemistry and Performance of Carbon Materials, Budapest, Hungary, June 2012

Poster presentations:

- K. Molnar, L. M. Vas, Composite nanofibers and nanofibrous composites prepared by electrospinning, EuroNanoForum2011, Budapest, Hungary, 30/05/2011
- K. Molnar, Zs. Nagy, B. Szolnoki, G. Szabenyi, A. Toldy, K. Bocz, Gy. Marosi, L. M. Vas, Preparation and characterization of carbon nanotube-loaded carbon nanofibres used as reinforcement for in epoxy resin composites, Nanofibers 2012, Tokyo, Japan, June 2012
- K. Molnar, L.M. Vas: Development of continuous electrospun precursors for carbon fiber manufacturing. ECCM 15, 15th European Conference on Composite Materials, Venice, Italy, 24-28 June 2012.
- G. Szabenyi, A. Toldy, K. Molnar, Development of MWCNT/carbon fiber reinforced epoxy matrix composites for aeronautical applications, 7th International Conference on Modification, Degradation and Stability, Prague, Czech Republic, September 2012

Book chapter:

- Molnar K., Vas L.M.: Electrospun Composite Nanofibers and Polymer Composites In: Bhattacharyya D. and Fakirov S. (edited by): Synthetic Polymer-Polymer Composites. Carl Hanser Verlag GmbH & Co. KG, Munchen 2012. Chapter 10, 301-349.

Papers:

- K. Molnar, E. Kostakova, L. Meszaros: Toughening effect of electrospun nanofibrous interleaves in carbon fiber reinforced epoxy laminates. Composites Science and Technology (CSTE-D-12-01107), under review
- K. Molnar, L.M. Vas: Development of continuous electrospun precursors for carbon fiber manufacturing. ECCM 15, 15th European Conference on Composite Materials, Venice, Italy, 24-28 June 2012. CD Proceeding, Paper ID: 568, pp 1-8.
- V. Quero Lopez, F. Sequeiros Murciano, F. Cano Perez, K. Molnar: Research activities on nano-materials and electromagnetic protection of composite aeronautical structures. ECCM 15, 15th European Conference on Composite Materials, Venice, Italy, 24-28 June 2012. CD Proceeding, Paper ID: 709, pp 1-9.
- A. Toldy, B. Szolnoki, G. Szabenyi, Development of MWCNT/carbon fiber reinforced composite for aerospace applications, 15th European Conference on Composite Materials, Venice, Italy, 24-28 June 2012. CD Proceeding, ID: 848, pp. 1-7.
- B. Szolnoki, A. Toldy, P. Konrad, G. Szabenyi, Gy. Marosi, Comparison of additive and reactive phosphorus-based flame retardants in carbon fibre reinforced epoxy resin composites, 15th European Conference on Composite Materials, Venice, Italy, 24-28 June 2012. CD Proceeding, Paper ID: 1020, pp. 1-5.

Patents connected to the project:

K. Molnar, Zs.K. Nagy, L. Meszaros, Gy. Marosi. High output spinneret and method for producing nanofibers. HU – No. 1200677/1 (2012).

K. Molnár, Zs K Nagy, L M Vas, T Czigány, J Karger-Kocsis, Gy. Marosi: Electrostatic process and device for coating particles by nano- and microstructures. HU – No. P1200119/1 (2012).

**Relevant contact details:**

Project coordinator: Andrea Toldy, Budapest University of Technology and Economics, Department of Polymer Engineering

e-mail: [atoldy@mail.bme.hu](mailto:atoldy@mail.bme.hu)

webpage: <http://pt.bme.hu>

address: H-1111 Budapest, Műegyetem rkp. 3.

telephone: +36 1 463 2462